



LB1287, 1288

Darlington Transistor Array

Overview

These ICs have circuit configuration of 5-unit Darlington transistor array consisting of NPN transistors and are capable of causing small input current to provide large current drive. They can be advantageously incorporated in equipment because the specially designed 14-pin DIP makes such equipment more compact.

Features

- Large maximum drive current : 400mA
- Large allowable power dissipation : 1.15W
- Wide range of operating supply voltage.
LB1287 5 to 30V, LB1288 5 to 20V
- Wide range of operating temperature.
-20 to +80°C
- Large current-amplification factor : 2000 or more

Applications

- Various types of driver (relay, solenoid, motor, etc.).
- Display segment or digit driver (LED, lamp).
- Interface to MOS or bipolar logic IC.
- Power amplification of pulse (fan-out extension, etc.).

Specifications

Absolute Maximum Ratings at $T_a = 25^\circ\text{C}$

Parameter	Symbol	Conditions	Ratings	Unit
Collector-base voltage	V_{CBO}	LB1287	30	V
		LB1288	20	V
Collector-emitter voltage	V_{CEO}^*	LB1287	-0.7 to +30	V
		LB1288	-0.7 to +20	V
Allowable power dissipation	$P_d \text{ max}$		1.15	W
Input voltage	V_{IN}	Per unit	-0.7 to +45	V
Collector current	I_C	Per unit	500	mA
Junction temperature	T_J		125	°C
Operating temperature	T_{opr}		-20 to +80	°C
Storage temperature	T_{stg}		-40 to +125	°C

* : The substrate is connected to emitter.

Package Dimensions

unit:mm

3004A-DIP14TD

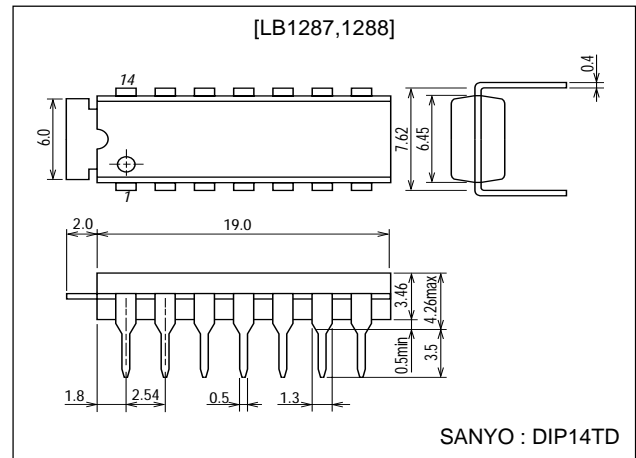

■ Any and all SANYO products described or contained herein do not have specifications that can handle applications that require extremely high levels of reliability, such as life-support systems, aircraft's control systems, or other applications whose failure can be reasonably expected to result in serious physical and/or material damage. Consult with your SANYO representative nearest you before using any SANYO products described or contained herein in such applications.

■ SANYO assumes no responsibility for equipment failures that result from using products at values that exceed, even momentarily, rated values (such as maximum ratings, operating condition ranges, or other parameters) listed in products specifications of any and all SANYO products described or contained herein.

SANYO Electric Co.,Ltd. Semiconductor Company

TOKYO OFFICE Tokyo Bldg., 1-10, 1 Chome, Ueno, Taito-ku, TOKYO, 110-8534 JAPAN

LB1287, 1288

Allowable Operating Ranges at Ta = 25°C

Parameter	Symbol	Conditions	Ratings	Unit
Supply voltage	V _{CC}	LB1287	5 to 30	V
		LB1288	5 to 20	V
Collector current	I _{cop1}	Turning ON 5 units simultaneously, Ta=80°C, 20% duty	280	mA
	I _{cop2}	Turning ON 5 units simultaneously, Ta=80°C, 50% duty	150	mA
	I _{cop3}	Turning ON 5 units simultaneously, Ta=80°C, DC	100	mA

Electrical Characteristics at Ta = 25°C

Parameter	Symbol	Conditions	Test circuit	Ratings			Unit
				min	typ	max	
Collector-base voltage	V _{CBO}	I _C =50μA : LB1287	A	30			V
		I _C =50μA : LB1288	A	20			V
Collector-emitter voltage	V _{CEO}	I _C =100μA : LB1287	B	30			V
		I _C =100μA : LB1288	B	20			V
DC current gain	h _{FE}	V _{CE} =5V, I _C =200mA	C	2000			
Collector-emitter saturation voltage	V _{CE(sat)}	V _{in} =12V, I _C =400mA	D			2.3	V
		V _{in} =9.5V, I _C =300mA	D			1.8	V
		V _{in} =7.0V, I _C =200mA	D			1.4	V
Input current	I _{IN}	V _{in} =17V	E		0.8		mA

Equivalent Circuit

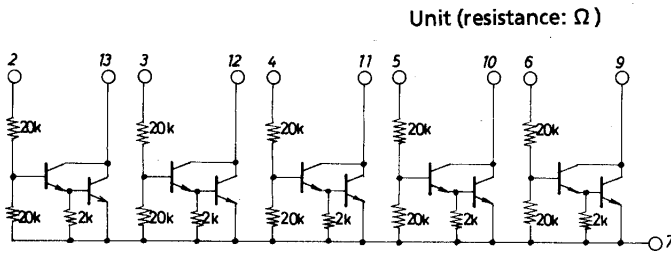

Note 1. pins 1, 8, 14 : NC

Note 2. The substrate is connected to pin 7.

Test Circuit

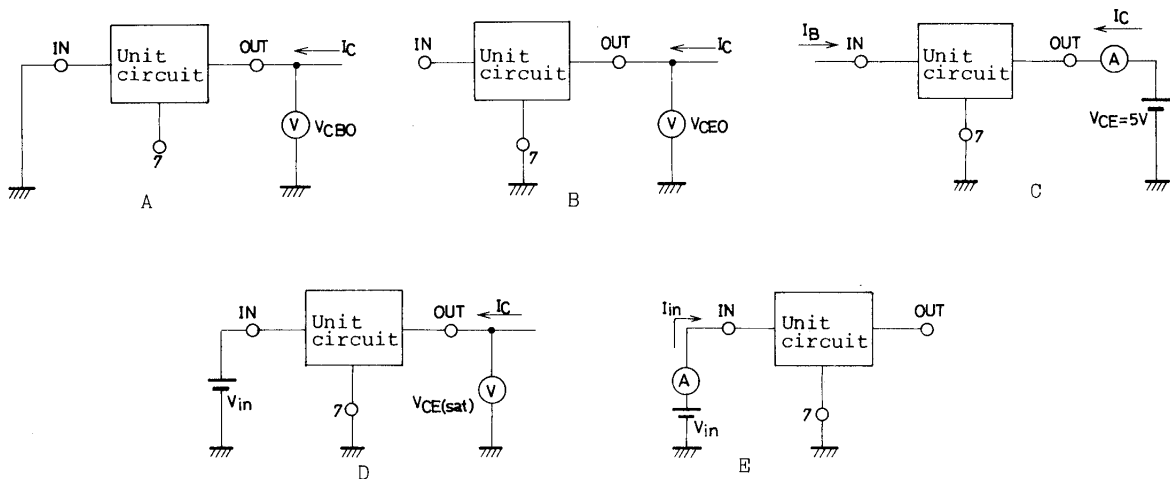

LB1287, 1288

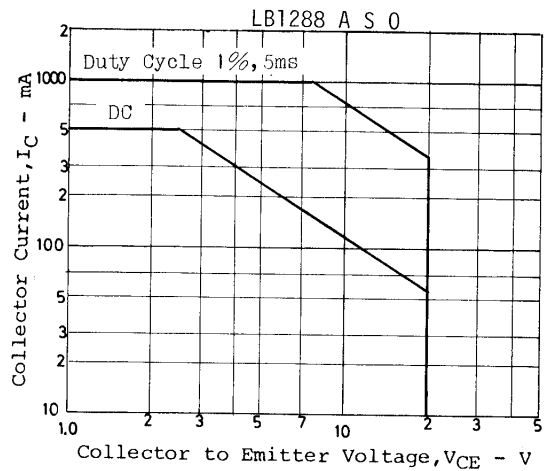
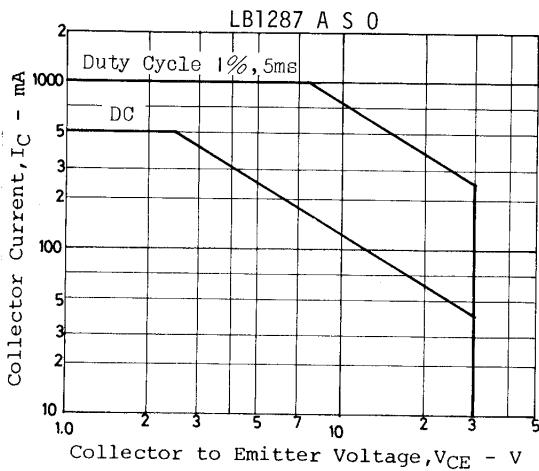
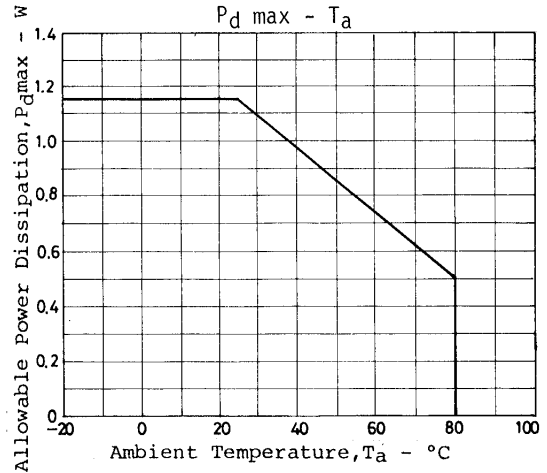
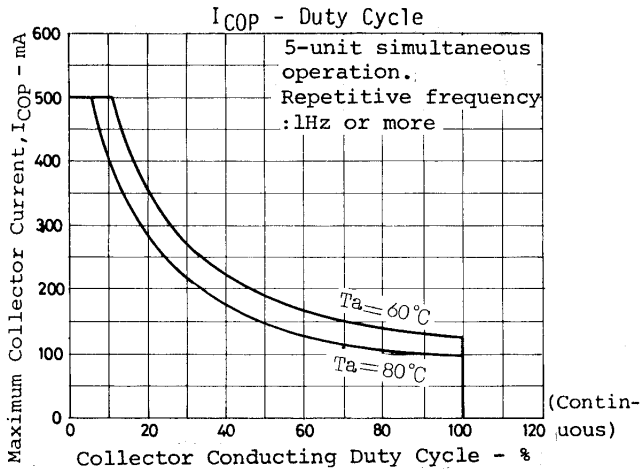

- Specifications of any and all SANYO products described or contained herein stipulate the performance, characteristics, and functions of the described products in the independent state, and are not guarantees of the performance, characteristics, and functions of the described products as mounted in the customer's products or equipment. To verify symptoms and states that cannot be evaluated in an independent device, the customer should always evaluate and test devices mounted in the customer's products or equipment.
- SANYO Electric Co., Ltd. strives to supply high-quality high-reliability products. However, any and all semiconductor products fail with some probability. It is possible that these probabilistic failures could give rise to accidents or events that could endanger human lives, that could give rise to smoke or fire, or that could cause damage to other property. When designing equipment, adopt safety measures so that these kinds of accidents or events cannot occur. Such measures include but are not limited to protective circuits and error prevention circuits for safe design, redundant design, and structural design.
- In the event that any or all SANYO products (including technical data, services) described or contained herein are controlled under any of applicable local export control laws and regulations, such products must not be exported without obtaining the export license from the authorities concerned in accordance with the above law.
- No part of this publication may be reproduced or transmitted in any form or by any means, electronic or mechanical, including photocopying and recording, or any information storage or retrieval system, or otherwise, without the prior written permission of SANYO Electric Co., Ltd.
- Any and all information described or contained herein are subject to change without notice due to product/technology improvement, etc. When designing equipment, refer to the "Delivery Specification" for the SANYO product that you intend to use.
- Information (including circuit diagrams and circuit parameters) herein is for example only; it is not guaranteed for volume production. SANYO believes information herein is accurate and reliable, but no guarantees are made or implied regarding its use or any infringements of intellectual property rights or other rights of third parties.

This catalog provides information as of February, 2001. Specifications and information herein are subject to change without notice.