



LA8670M

Double-Conversion Narrow-Band FM IF System

Overview

The LA8670M is a narrow band FM IF system for use in communication equipment. In addition to the functions required for FM reception, the LA8670M provides a rich set of additional functions including noise detection and field strength detection, and is thus optimal for cordless telephones.

Functions

- First mixer, first local oscillator, first local oscillator buffer output, second mixer, second local oscillator
- IF amplifier, limiter, quadrature detector
- Signal meter
- Noise detector, noise amplifier, noise wave detector, Schmitt trigger

Features

- Low voltage operation: $V_{CC\text{ OP}} = 1.8$ to 6 V
- Signal meter linear over a wide range (70 dB typical)
- High sensitivity, high intercept point

Specifications

Maximum Ratings at $T_a = 25^\circ\text{C}$

Parameter	Symbol	Conditions	Ratings	Unit
Maximum supply voltage	$V_{CC\text{ max}}$		7.0	V
Allowable power dissipation	$P_{d\text{ max}}$	$T_a \leq 75^\circ\text{C}$	150	mW
Operating temperature	T_{opr}		-20 to +75	$^\circ\text{C}$
Storage temperature	T_{stg}		-40 to +125	$^\circ\text{C}$

Operating Conditions at $T_a = 25^\circ\text{C}$

Parameter	Symbol	Conditions	Ratings	Unit
Recommended supply voltage	V_{CC}		3.0	V
Operating supply voltage	$V_{CC\text{ OP}}$		1.8 to 6.0	V

Package Dimensions

unit: mm

3112-MFP24S

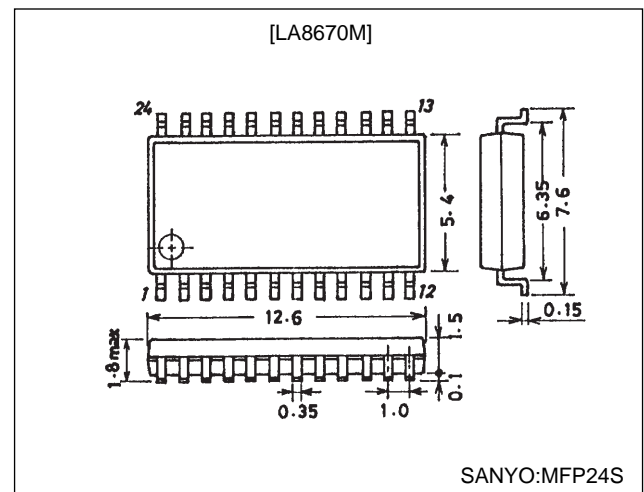

LA8670M

Operating Characteristics at $T_a = 25^\circ\text{C}$, $V_{CC} = 3\text{ V}$, $f_C (\text{MIX}) = 49.830\text{ MHz}$, $f_{\text{mod}} = 1\text{ kHz}$, $\Delta f = \pm 3\text{ kHz}$

Parameter	Symbol	Conditions	min	typ	max	Unit
Quiescent current	I_{CCO}	No input		7.3	9.5	mA
Mixer intercept point	I_{p3}	First mixer		-4.8		dBm
12 dB sensitivity	12dB S/N	No input matching		3.2	5.0	dB μ
Demodulator output	V_O	$V_{in} = 80\text{ dB}\mu$	143	180	227	mVrms
Signal-to-noise ratio	S/N	No modulation, $V_{in} = 80\text{ dB}\mu$	60	67		dB
AM rejection ratio	AMR	AM 30% modulation	35	43		dB
Total harmonic distortion	THD	$V_{in} = 80\text{ dB}\mu$		2.2	3.0	%
Signal meter output	$V_{SM(1)}$	$V_{in} = 0\text{ dB}\mu$	0.05	0.30	0.65	V
	$V_{SM(2)}$	$V_{in} = 40\text{ dB}\mu$	0.60	0.90	1.40	V
	$V_{SM(3)}$	$V_{in} = 80\text{ dB}\mu$	1.05	1.40	1.85	V
Noise detector output	$V_{ND(1)}$	$f_i = 40\text{ kHz}$, $V_i = -50\text{ dBV}$		0.10	0.25	V
	$V_{ND(2)}$	$f_i = 40\text{ kHz}$, $V_i = -30\text{ dBV}$	1.10	1.40	1.70	V
Noise detector level	$V_{14(1)}$	Schmitt on	0.53	0.63	0.73	V
	$V_{14(2)}$	Schmitt off	0.33	0.43	0.53	V
Schmitt output level	$V_{SH(1)}$	$V_{14} = 0.8\text{ V}$			0.3	V
	$V_{SH(2)}$	$V_{14} = 0.2\text{ V}$	2.8			V
Mixer conversion gain	G_{M1}	First mixer		19		dB
	G_{M2}	Second mixer		24		dB
Mixer input frequency					90	MHz
Mixer input resistance		First mixer		5		k Ω
		Second mixer		330		Ω
Mixer output resistance		First mixer		330		Ω
		Second mixer		2.0		k Ω
FM detector output impedance				520		Ω

Note: AC levels are all indicated for open (EMF) circuits.

Equivalent Circuit Block Diagram

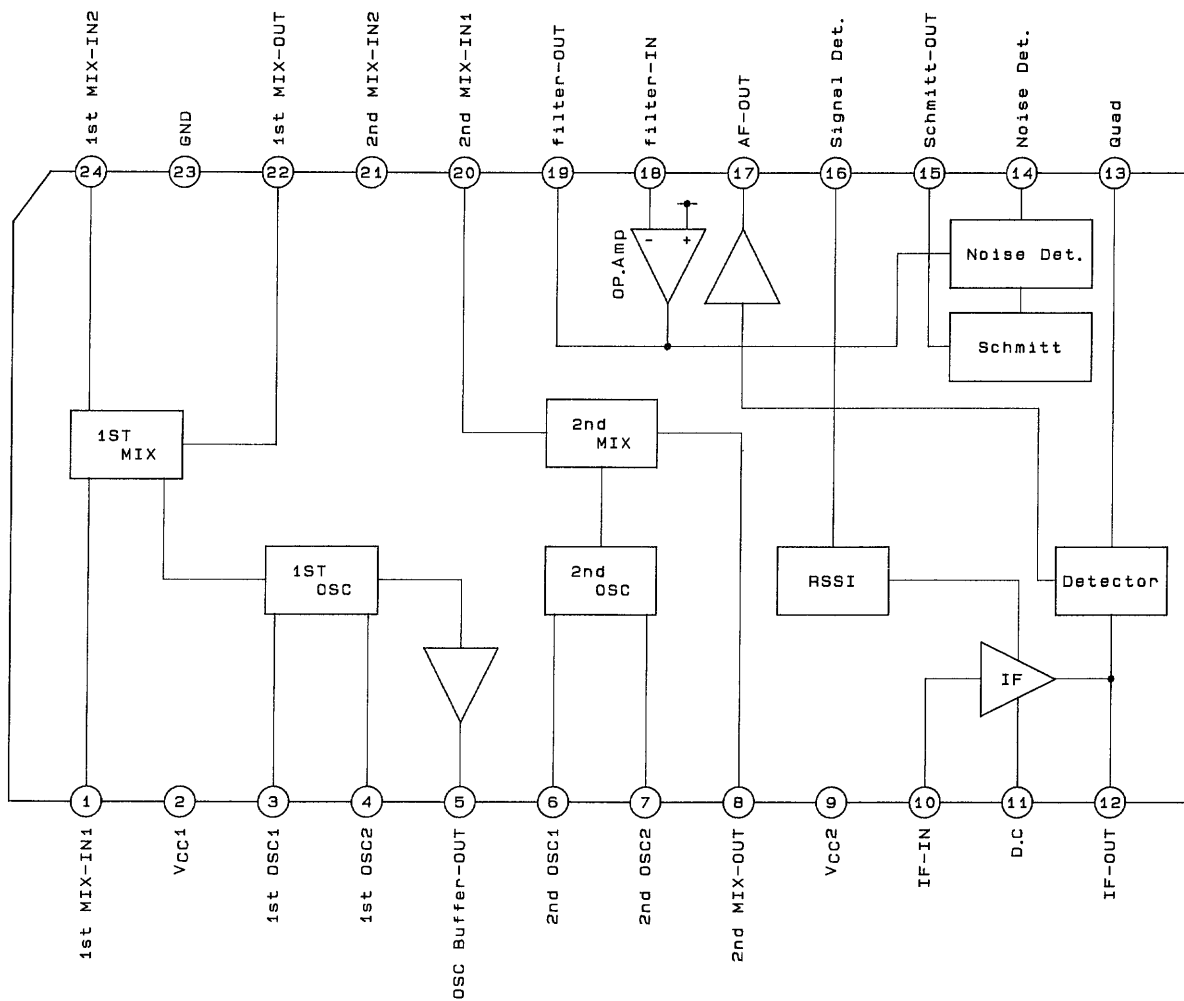

A02796

LA8670M

Test Circuit

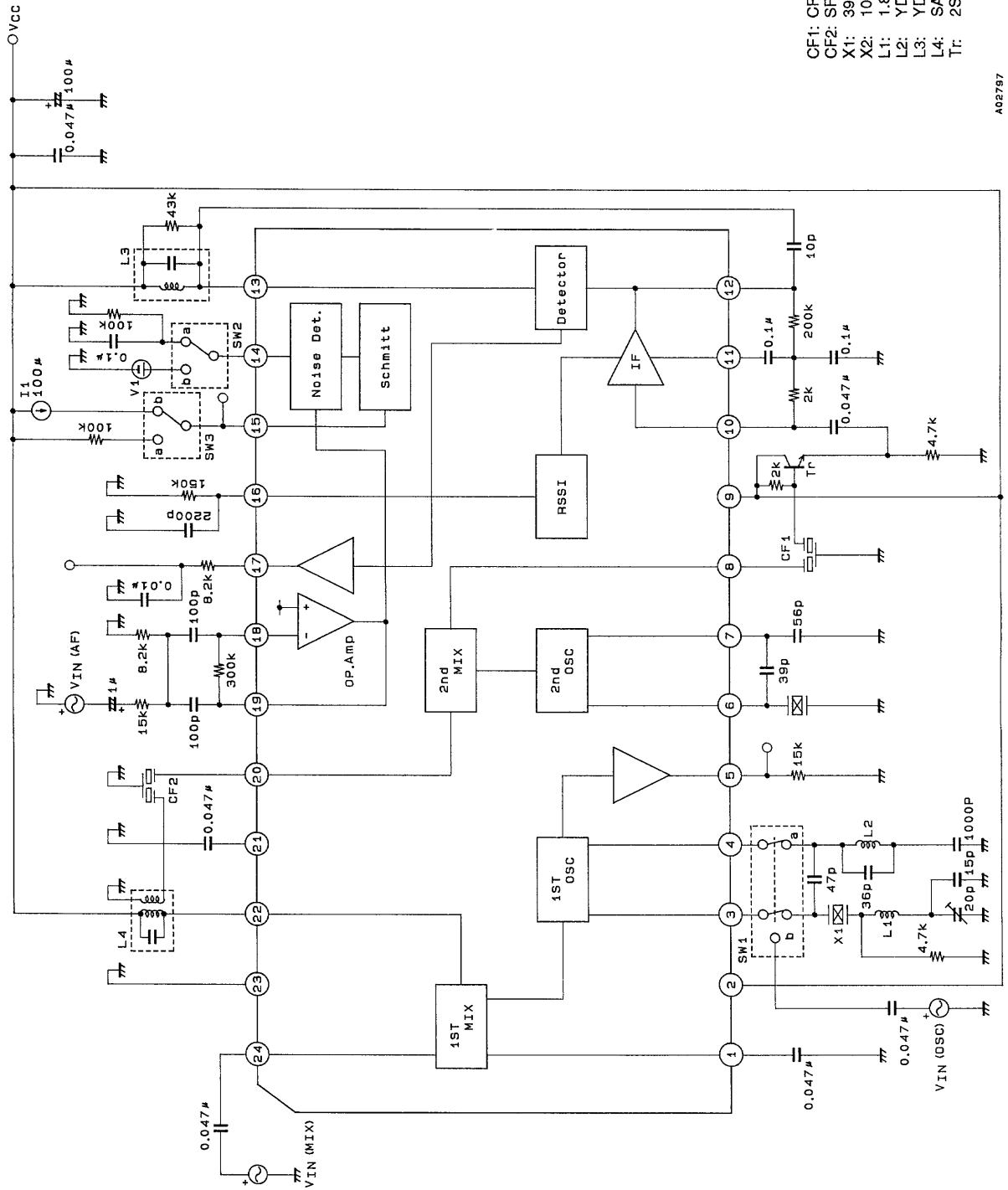

- CF1: CFW455F (Murata Mfg. Co., Ltd.)
- CF2: SFE10.7MS2 (Murata Mfg. Co., Ltd.)
- X1: 39.130 MHz
- X2: 10.245 MHz
- L1: 1.8 μH
- L2: YD1002 (Mitsumi Electric Co., Ltd.)
- L3: YD0051 (Mitsumi Electric Co., Ltd.)
- L4: SA-246 (Sumida)
- T: 2SC2999

Unit (resistance: Ω, capacitance: F)

Sample Application Circuit

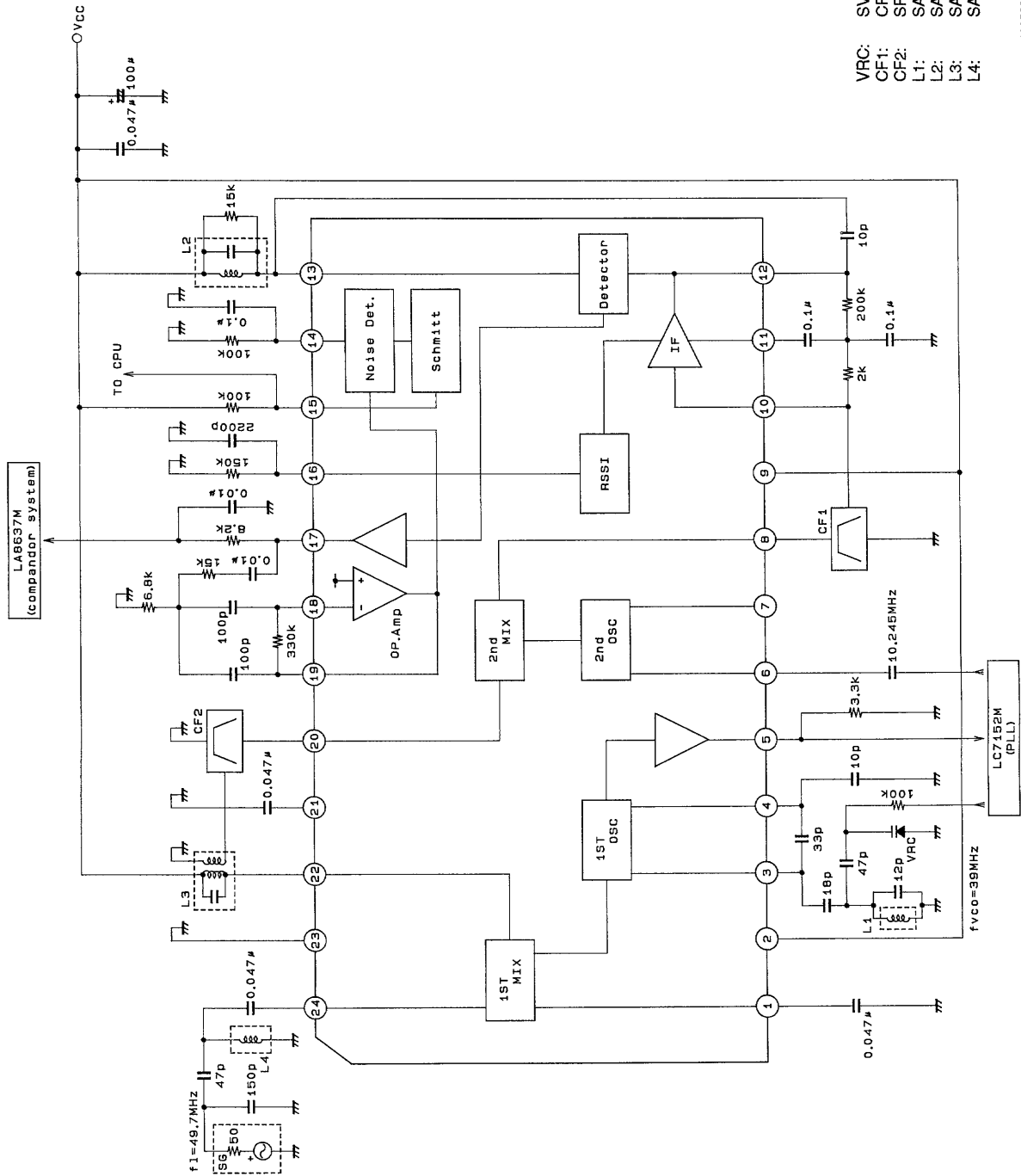

- VFC: SVC201SPA (Sanyo Electric Co., Ltd.)
- CF1: CFW455F (Murata Mfg. Co., Ltd.)
- CF2: SFE10.7MS2 (Murata Mfg. Co., Ltd.)
- L1: SA-254 (Sumida)
- L2: SA-257 (Sumida)
- L3: SA-246 (Sumida)
- L4: SA-289 (Sumida)

A02789 Unit (resistance: Ω, capacitance: F)

LA8670M

Pin Functions

Pin No.	Symbol	Internal equivalent circuit	Note
24	1st MIX-IN 2		First mixer inputs
1	1st MIX-IN 1		
2	V _{CC1}		Power supply for the first mixer
3	1st OSC 1		Local oscillator inputs
4	1st OSC 2		
5	OSC Buffer-OUT		Local oscillator buffer output
6	2nd OSC 1		Local oscillator inputs When external insertion is used, input the signal to pin 6 and leave pin 7 open.
7	2nd OSC 2		
8	2nd MIX-OUT		Second mixer output
9	V _{CC2}		Power supply
10	IF-IN		IF amplifier input
11	D.C		
12	IF-OUT		Limiter amplifier output

Continued on next page.

LA8670M

Continued from preceding page.

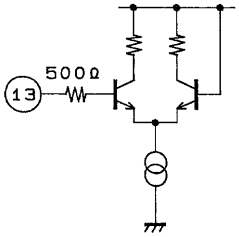
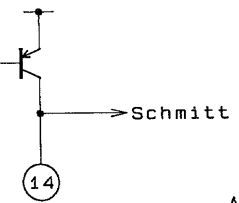
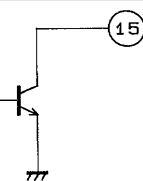
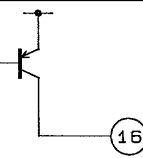
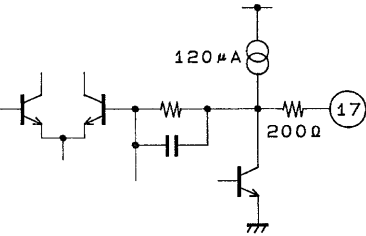
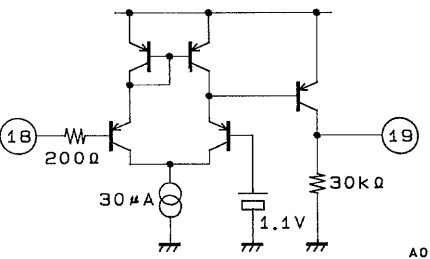
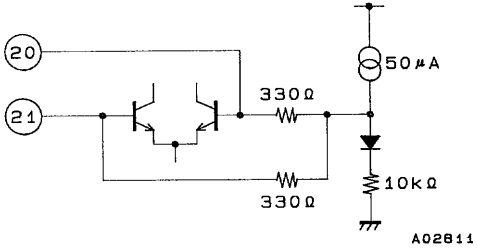
Pin No.	Symbol	Internal equivalent circuit	Note
13	Quad.	 <p style="text-align: right;">A02805</p>	Discriminator connection
14	Noise det.	 <p style="text-align: right;">A02806</p>	Noise detector
15	Schmitt-OUT	 <p style="text-align: right;">A02807</p>	Noise Schmitt output
16	Signal DET.	 <p style="text-align: right;">A02808</p>	Field strength signal output
17	AF-OUT	 <p style="text-align: right;">A02809</p>	FM detector output
18	Filter-IN	 <p style="text-align: right;">A02810</p>	Noise filter input
19	Filter-OUT		Noise filter output
20	2nd MIX-IN 1	 <p style="text-align: right;">A02811</p>	Second mixer input
21	2nd MIX-IN 2		

Continued on next page.

LA8670M

Continued from preceding page.

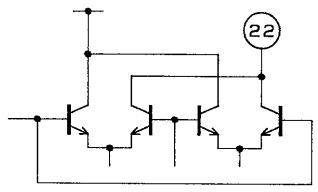
Pin No.	Symbol	Internal equivalent circuit	Note
22	1st MIX-OUT	 <p style="text-align: right;">A02B12</p>	First mixer output
23	GND		Ground

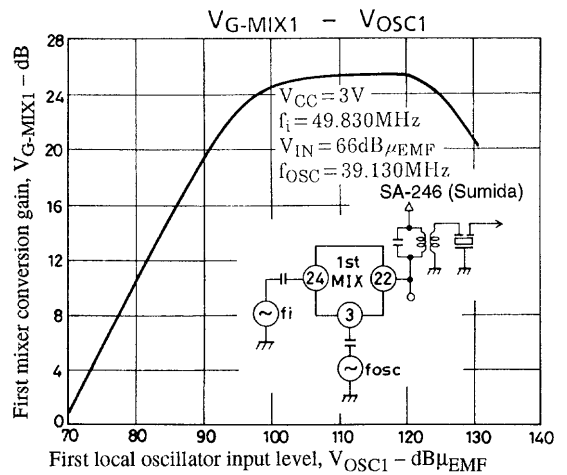
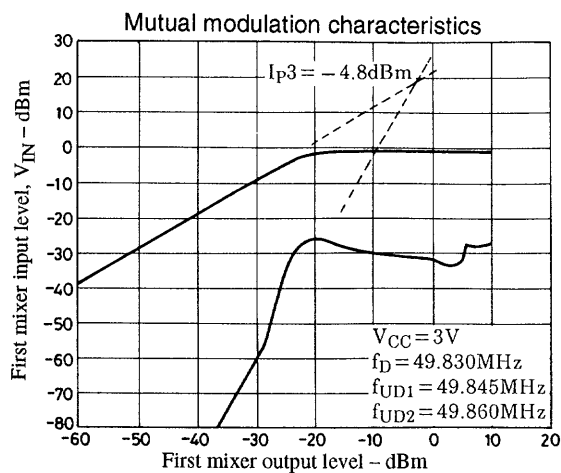
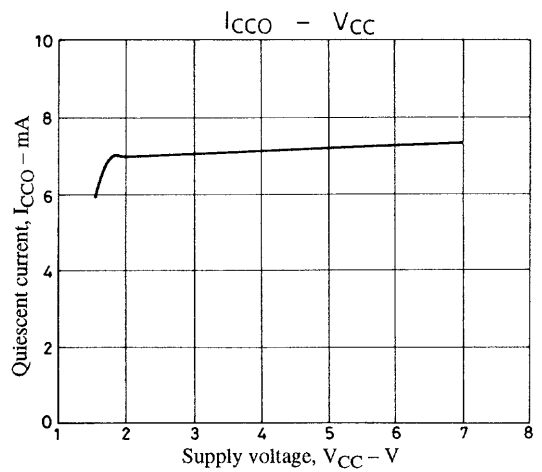
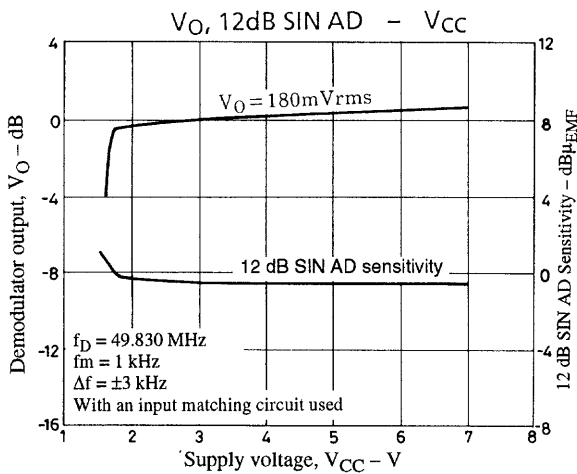
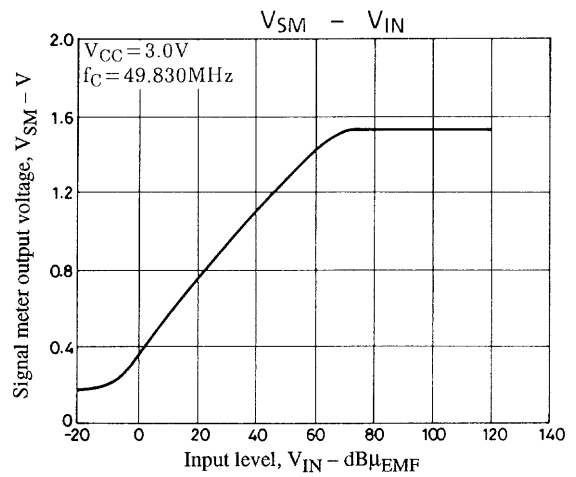
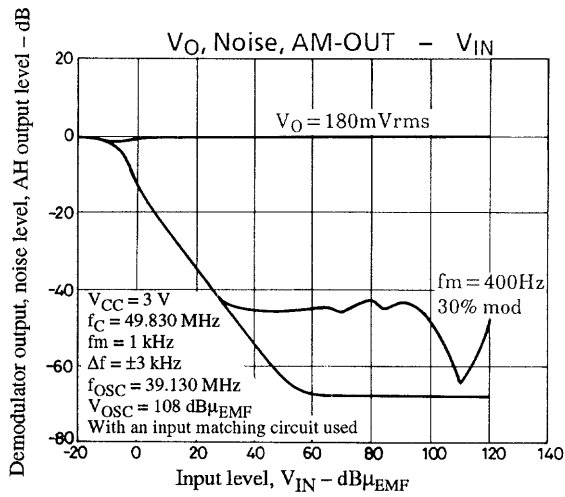

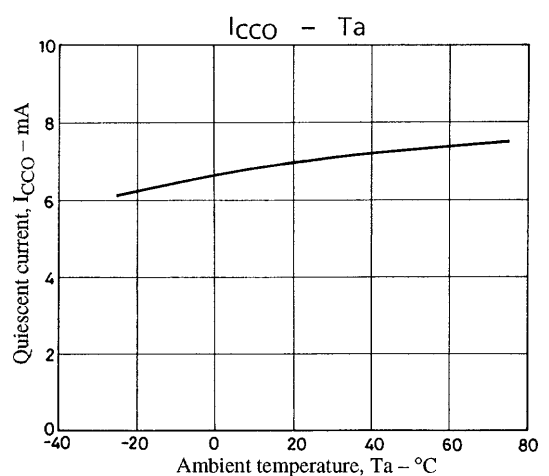
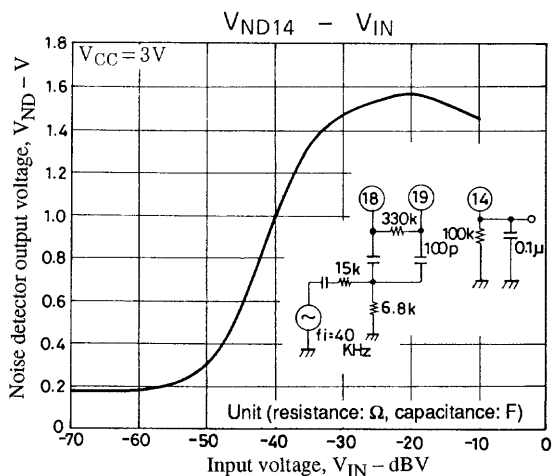
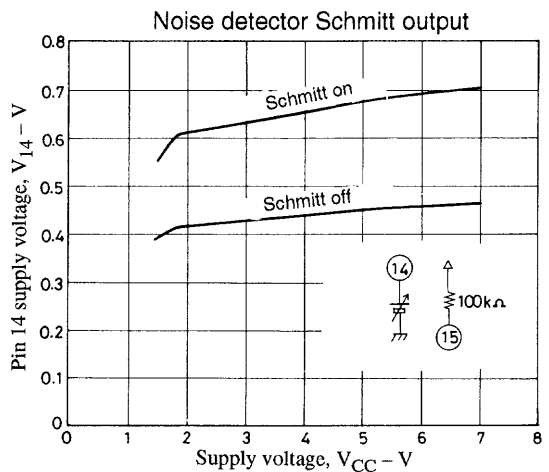
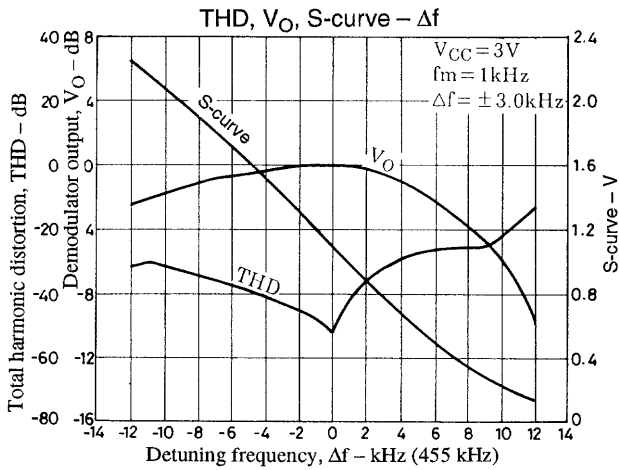
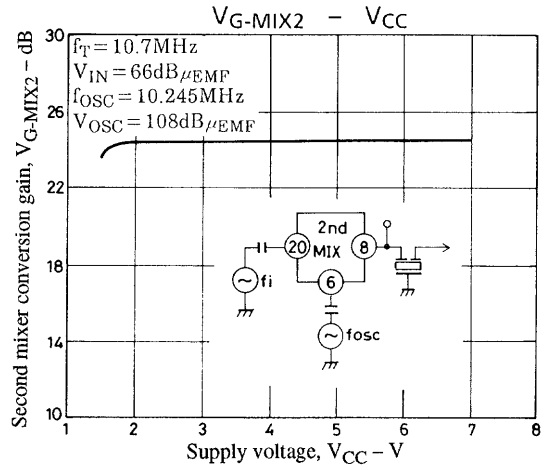
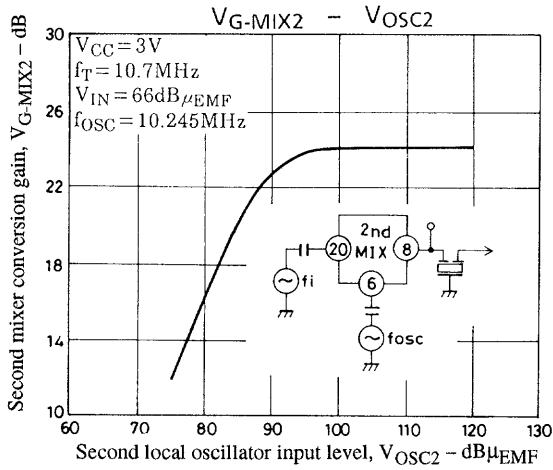
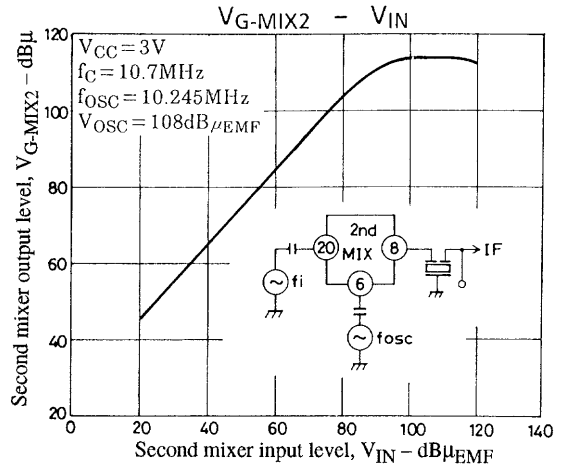
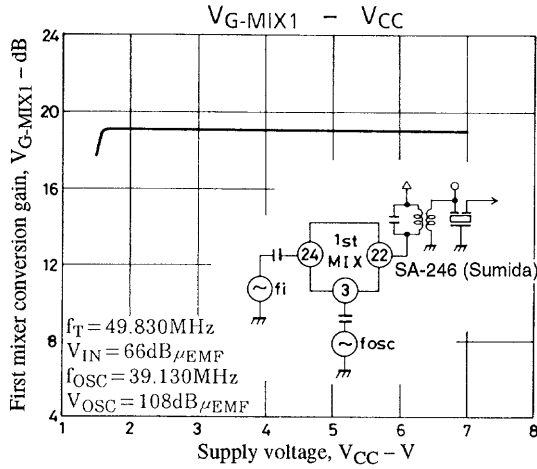

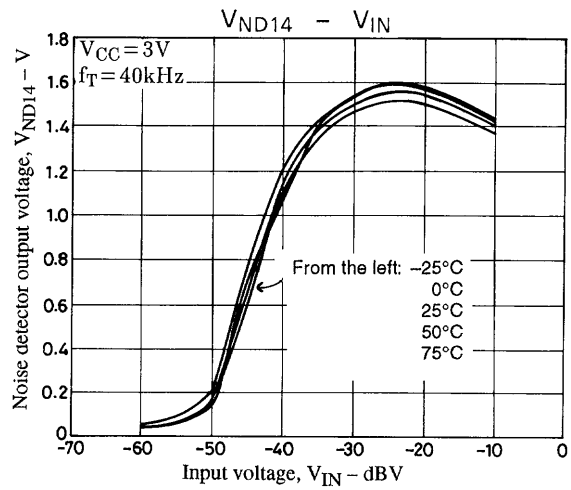
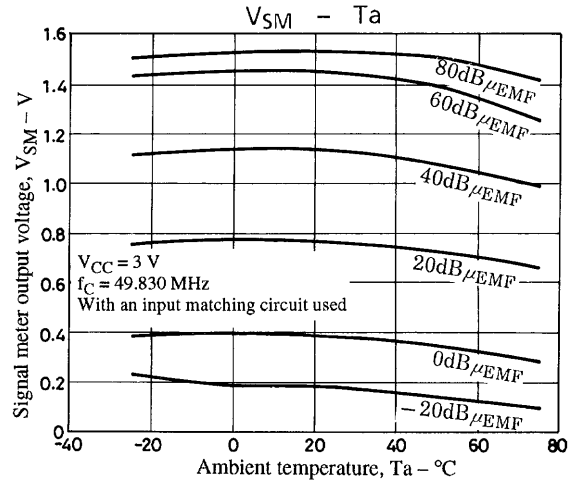
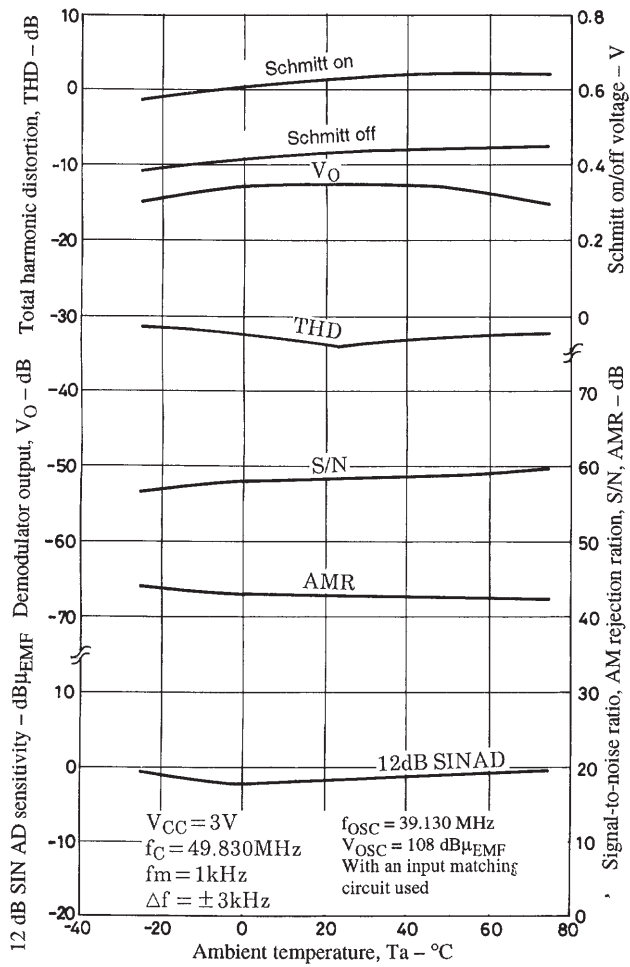

- No products described or contained herein are intended for use in surgical implants, life-support systems, aerospace equipment, nuclear power control systems, vehicles, disaster/crime-prevention equipment and the like, the failure of which may directly or indirectly cause injury, death or property loss.
- Anyone purchasing any products described or contained herein for an above-mentioned use shall:
 - ① Accept full responsibility and indemnify and defend SANYO ELECTRIC CO., LTD., its affiliates, subsidiaries and distributors and all their officers and employees, jointly and severally, against any and all claims and litigation and all damages, cost and expenses associated with such use:
 - ② Not impose any responsibility for any fault or negligence which may be cited in any such claim or litigation on SANYO ELECTRIC CO., LTD., its affiliates, subsidiaries and distributors or any of their officers and employees jointly or severally.
- Information (including circuit diagrams and circuit parameters) herein is for example only; it is not guaranteed for volume production. SANYO believes information herein is accurate and reliable, but no guarantees are made or implied regarding its use or any infringements of intellectual property rights or other rights of third parties.

This catalog provide information as of May, 1995. Specifications and information herein are subject to change without notice.