

SANYO	No.3325	LA8510
	Telephonic Speech Network	

Overview

The Sanyo LA8510 Telephonic Speech Network provides amplification, switching and line drive functions for telephone equipment. It can perform 2 to 4 line conversion and impedance matching, and supports both DTMF and keytone signals.

The LA8510's low operating current reduces line load. Switching between the DTMF/keytone and voice circuits is controlled directly from a single MUTE input.

The LA8510 is available in plastic 20-pin DIPs.

Features

- Direct connection to low-impedance receiver
- DTMF/keytone and voice circuit switching controlled by a single MUTE input
- Receive and transmit gain are adjusted automatically in response to the line current.
- Applicable to a wide variety of transmitters and receivers by selecting external components.

Maximum Ratings at Ta = 25°C

			unit
Line Voltage	V _L max	15	V
Line Current	I _L max	150	mA
Allowable Power Dissipation	P _d max	1200	mW
Operating Temperature	T _{opr}	-30 to +75	°C
Storage Temperature	T _{stg}	-55 to +150	°C

Operating Characteristics at Ta = 25°C, f = 1kHz, See specified Test Circuit.

			min	typ	max	unit
Line Voltage	V _L	I _L = 20mA		3.2		V
		I _L = 50mA		5.3		V
		I _L = 120mA		10.6		V
Supply Voltage	V _{CC}	I _L = 20mA		2.3		V
		I _L = 50mA		4.0		V
		I _L = 120mA		7.9		V

Continued on next page.

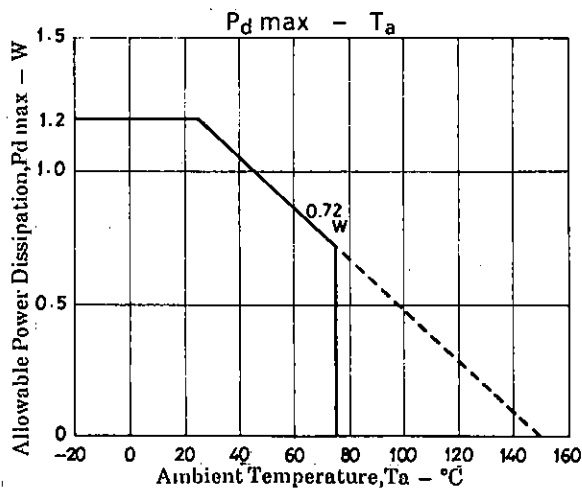

Package Dimensions

(unit: mm)

3021B

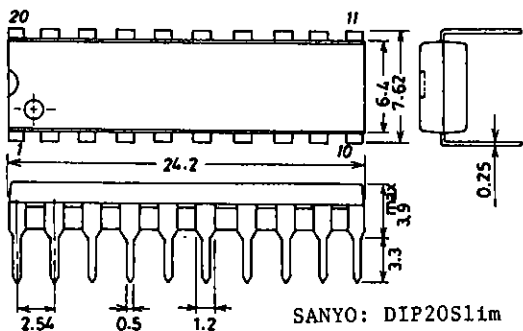

LA8510

Continued from preceding page.

			min	typ	max	unit
Transmit Gain	G_T	$I_L = 20\text{mA}, V_{IN} = -55\text{dBV}$	38	40	42	dB
		$I_L = 120\text{mA}, V_{IN} = -55\text{dBV}$	35	37		dB
Receive Gain	G_R	$I_L = 20\text{mA}, V_{IN} = -20\text{dBV}$	7.5	10	12.5	dB
		$I_L = 120\text{mA}, V_{IN} = -20\text{dBV}$	1.5	4	6.5	dB
DTMF Gain	G_{MF}	$I_L = 20\text{mA}, V_{IN} = -30\text{dBV}$	23	25	27	dB
		$I_L = 120\text{mA}, V_{IN} = -30\text{dBV}$	20	22		dB
Transmit Dynamic Range	DR_T	$I_L = 20\text{mA}, \text{THD} = 4\%$	2.5			Vpp
		$I_L = 120\text{mA}, \text{THD} = 4\%$	4.6			Vpp
Receive Dynamic Range	DR_R	$I_L = 20\text{mA}, \text{THD} = 10\%$	2.0			Vpp
		$I_L = 120\text{mA}, \text{THD} = 10\%$	6.0			Vpp
DTMF Input Impedance	Z_{IMF}	$I_L = 50\text{mA}$	24			k Ω
KTI Input Impedance	Z_{KTI}	$I_L = 50\text{mA}$	17			k Ω
MUTE "H"-Level Input Voltage	V_{IH}	$I_L = 20\text{mA to } 120\text{mA}$	1.5		V_{CC}	V
MUTE "L"-Level Input Voltage	V_{IL}	$I_L = 20\text{mA to } 120\text{mA}$	0		0.2	V
Transmit Attenuation	ΔG_T	$I_L = 30\text{mA}, \text{PADC grounded via } 24\text{k}\Omega$		3		dB
Receive Attenuation	ΔG_R	$I_L = 30\text{mA}, \text{PADC grounded via } 24\text{k}\Omega$		6		dB
Reference Voltage	V_{REF}	$I_L = 20\text{mA}$		0.7		V
		$I_L = 50\text{mA}$		1.3		V
		$I_L = 120\text{mA}$		2.4		V

Note) Be careful of dielectric breakdown.

Equivalent Circuit Block Diagram

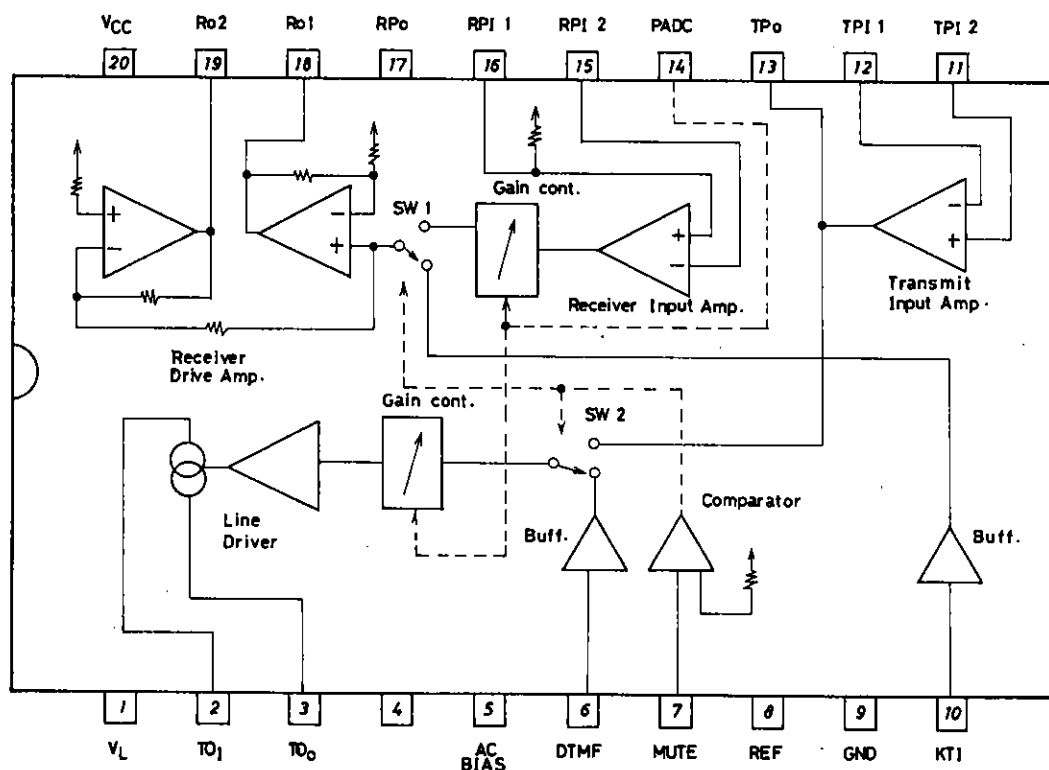

LA8510

Pin Descriptions

Pin Number	Pin Name	Description
1	V_L	Line voltage Connected to the positive side of the line diode bridge. See the application circuit.
2	TO_1	Transmit output current source, input side Connected to V_L through a 27Ω resistor. Select the value of this resistor after considering the maximum expected line current.
3	TO_0	Transmit output current source, output side As above, but to ground through a 15Ω resistor
4		Not used. This pin has a DC bias and should not be connected.
5	AC BIAS	AC signal reference voltage An internally-generated reference voltage.
6	DTMF	DTMF input The signal on this pin is output on V_L (pin 1) when MUTE (pin 7) is LOW. It should be decoupled using a capacitor since it is biased with the REF voltage.
7	MUTE	Mute control input Switches between the transmit side DTMF or receive side keytone, and voice circuits. LOW : DEMF output, keytone receive output HIGH : Voice circuits
8	REF	Reference voltage Internal amplifier bias voltage. Requires an external capacitor. This voltage should not be used by external circuitry.
9	GND	Ground Connected to the negative side of the line diode bridge.
10	KTI	Key tone input Switched through to the receive circuit output when MUTE (pin 7) is LOW. It should be decoupled using a capacitor since it is biased with REF voltage.
11	TPI_2	Transmit input amp non-inverting input Transmit voice circuit input. Requires a DC bias from REF (pin 8) through a resistor.
12	TPI_1	Transmit input amp inverting input Negative feedback input. Amplifier gain and frequency response are controlled by the feedback network.
13	TP_0	Transmit input amp output
14	PADC	Pad control input The value of the resistor between this pin and either V_{CC} or ground determines the shape of the line-current vs. gain characteristics. See Electrical Characteristics.
15	RPI_2	Receive input amp inverting input Negative feedback is applied from the amplifier output to control amplifier gain and frequency response.
16	RPI_1	Receive input amp non-inverting input This pin is internally biased through a resistor using REF.
17	RP_0	Receive input amp output
18	RO_1	Receive circuit output BTL output. Connect a ceramic receiver between RO_1 and RO_2 .
19	RO_2	
20	V_{CC}	Supply voltage Supply voltage for internal circuitry. This supply should not be used as an external circuit supply except as the high-level voltage for the MUTE and PADC inputs.

DC Characteristics

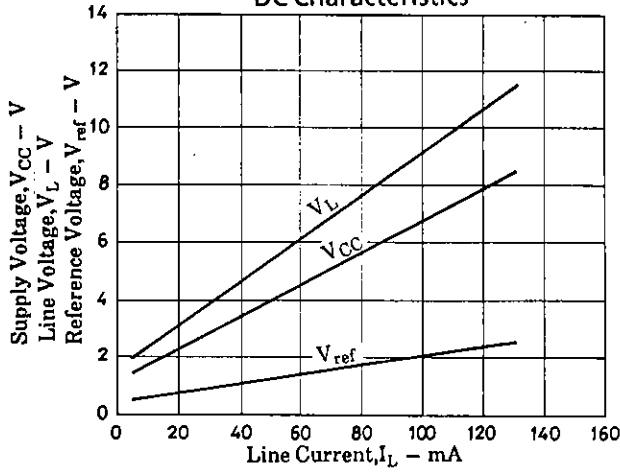

Transmit Gain - I_L

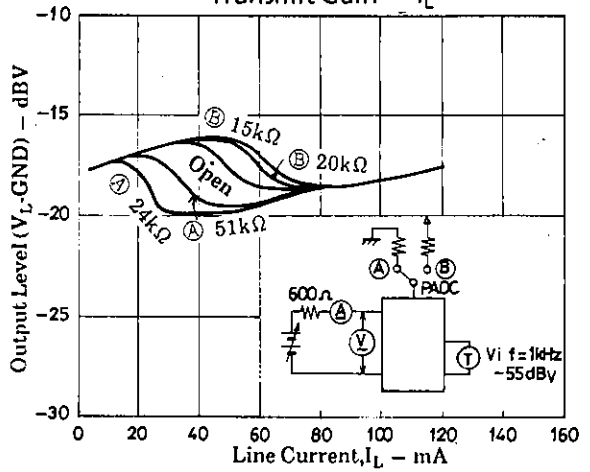

Transmit Dynamic Range - I_L

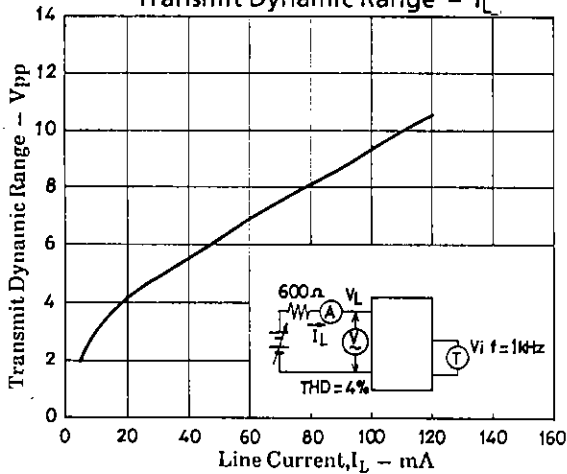

Receive Gain - I_L

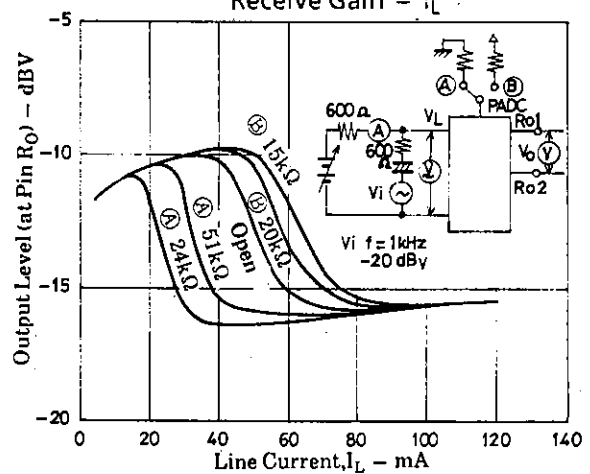

Receive Dynamic Range - I_L

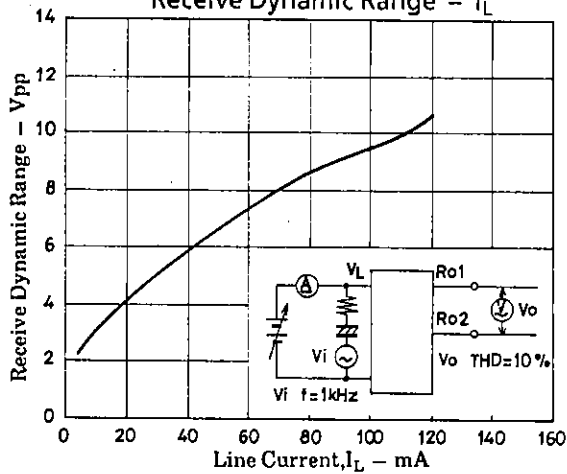

DTMF Gain - I_L

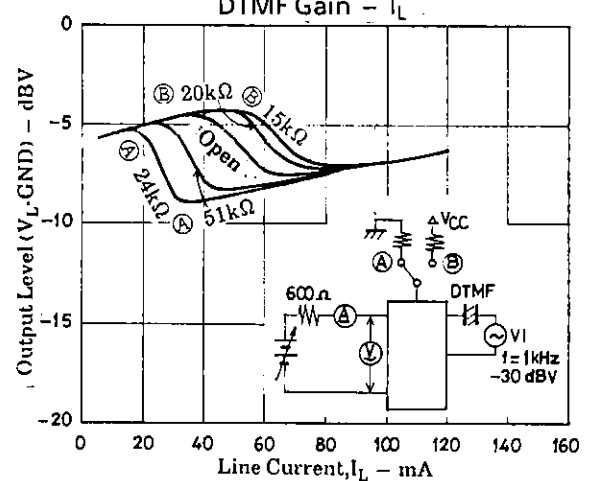

DTMF Transmit Dynamic Range - I_L

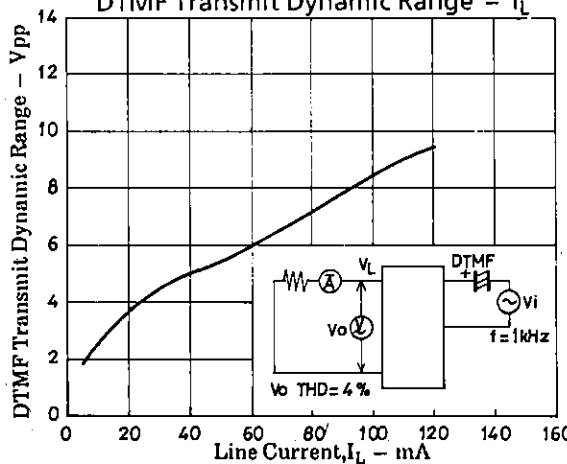

- No products described or contained herein are intended for use in surgical implants, life-support systems, aerospace equipment, nuclear power control systems, vehicles, disaster/crime-prevention equipment and the like, the failure of which may directly or indirectly cause injury, death or property loss.
- Anyone purchasing any products described or contained herein for an above-mentioned use shall:
 - ① Accept full responsibility and indemnify and defend SANYO ELECTRIC CO., LTD., its affiliates, subsidiaries and distributors and all their officers and employees, jointly and severally, against any and all claims and litigation and all damages, cost and expenses associated with such use:
 - ② Not impose any responsibility for any fault or negligence which may be cited in any such claim or litigation on SANYO ELECTRIC CO., LTD., its affiliates, subsidiaries and distributors or any of their officers and employees jointly or severally.
- Information (including circuit diagrams and circuit parameters) herein is for example only; it is not guaranteed for volume production. SANYO believes information herein is accurate and reliable, but no guarantees are made or implied regarding its use or any infringements of intellectual property rights or other rights of third parties.