

**LA5645T****Constant-Voltage/Constant-Current Control IC****Overview**

The LA5645T is a constant-voltage/constant-current control IC that incorporates low-voltage operational amplifiers and a high-precision reference voltage circuit ($V_{REF} = 1.5 \text{ V} \pm 1.0\%$). This device is optimal for use as a secondary side controller in battery chargers, switching regulators, and similar products.

Features

- Operating supply voltage: 2.5 to 14 V
- High-precision reference voltage: $1.5 \text{ V} \pm 1.0\%$
- PC pin current: 60 mA (max)
- Current drain: 3 mA (max)
- Input offset voltage: 2 mV (max)

Package Dimensions

unit: mm

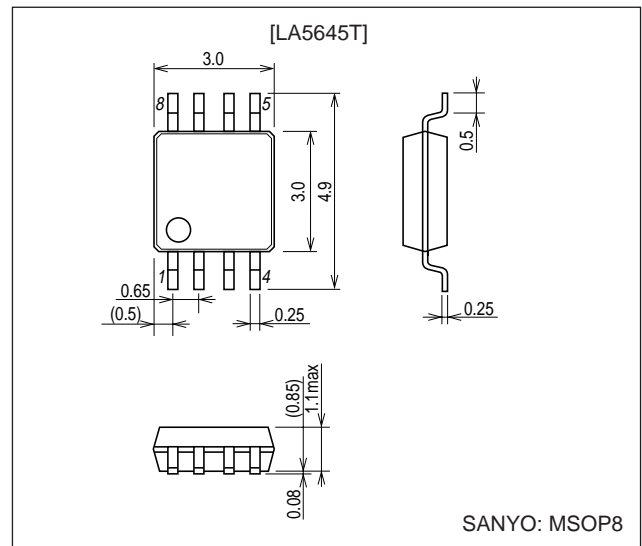
3245-MSOP8**Specifications****Maximum Ratings at $T_a = 25^\circ\text{C}$**

Parameter	Symbol	Conditions	Ratings	Unit
Supply voltage	$V_{CC \text{ max}}$		14.5	V
Differential input voltage	$V_{ID \text{ max}}$		14.5	V
Allowable power dissipation	$P_d \text{ max}$	Independent IC	200	mW
		Mounted on the specified printed circuit board*	370	mW
PC pin current	$I_{PC \text{ max}}$		60	mA
Operating temperature	T_{opr}		-40 to +85	$^\circ\text{C}$
Storage temperature	T_{stg}		-50 to +150	$^\circ\text{C}$

Note: * Specified printed circuit board: $20 \times 10 \times 0.8 \text{ mm}^3$, paper phenolic board.

Operating Conditions at $T_a = 25^\circ\text{C}$

Parameter	Symbol	Conditions	Ratings	Unit
Recommended supply voltage	V_{opr}		2.5 to 14	V

■ Any and all SANYO products described or contained herein do not have specifications that can handle applications that require extremely high levels of reliability, such as life-support systems, aircraft's control systems, or other applications whose failure can be reasonably expected to result in serious physical and/or material damage. Consult with your SANYO representative nearest you before using any SANYO products described or contained herein in such applications.

■ SANYO assumes no responsibility for equipment failures that result from using products at values that exceed, even momentarily, rated values (such as maximum ratings, operating condition ranges, or other parameters) listed in products specifications of any and all SANYO products described or contained herein.

SANYO Electric Co.,Ltd. Semiconductor Company

TOKYO OFFICE Tokyo Bldg., 1-10, 1 Chome, Ueno, Taito-ku, TOKYO, 110-8534 JAPAN

LA5645T

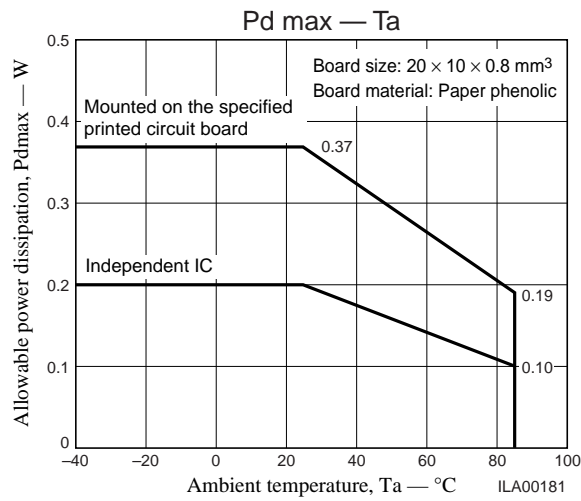

Electrical Characteristics at Ta = 25°C, VCC = 5 V

Parameter	Symbol	Conditions	Ratings			Unit
			min	typ	max	
Current drain	I_{CC}	$I_{PC} = \text{OFF}$		1	3	mA
Leakage current	$I_{PC \text{ LEAK}}$	$V_{CC} = V_{PC} = 14 \text{ V}$			100	μA
Saturation voltage	$V_{PC} (\text{sat})$	$I_{PC} = 50 \text{ mA}$		0.5	0.7	V
Reference voltage	V_{REF}	$I_{REF} = 0 \text{ mA}$	1485	1500	1515	mV
Reference voltage regulation	$\Delta V_{REF}/\Delta I_{REF}$	$I_{REF} = 0 \text{ to } 5 \text{ mA}$			30	mV
[Amplifier Block] (Characteristics common to both channels A and B)						
Input offset voltage	V_{IO}			0.5	2	mV
Input offset current	I_{IO}			5	50	nA
Input bias current	I_B			80	250	nA
Voltage gain	A_V	Open loop gain (design guarantee*)		80		dB
Common-mode input voltage range	V_{ICM}		0		$V_{CC} - 2$	V
Slew rate	SR	Design guarantee*		0.8		V/ μs
Gain-bandwidth product	GB	Design guarantee*		2		MHz

Note: * Design guarantee value. These parameters are not measured.

Pin Assignment

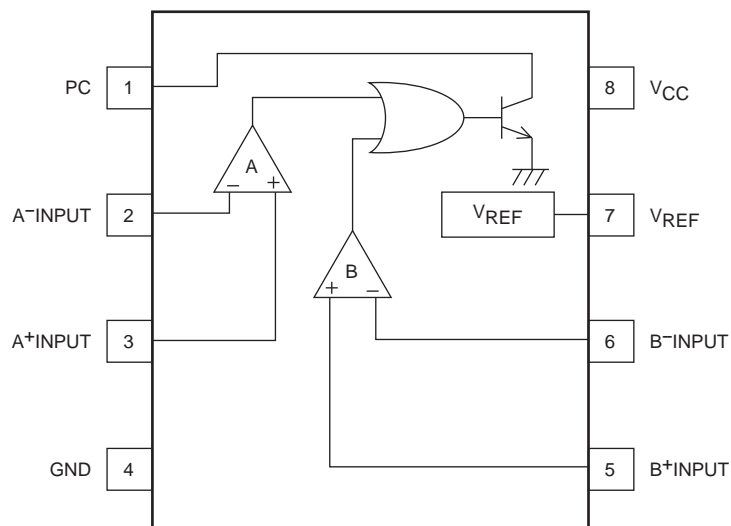

ILA00182

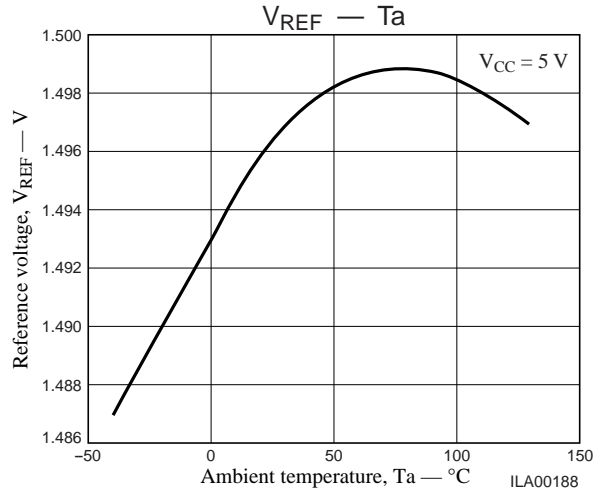
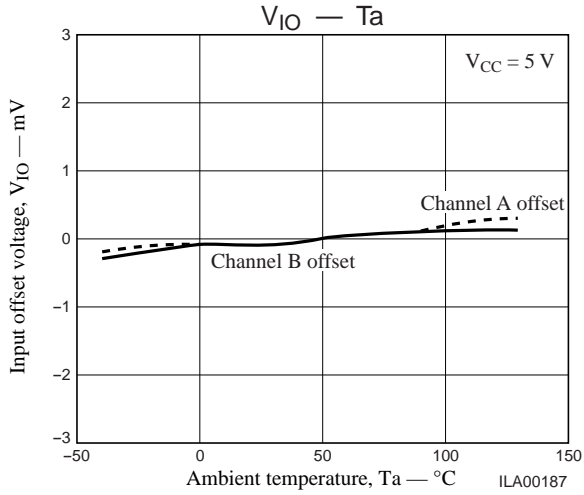
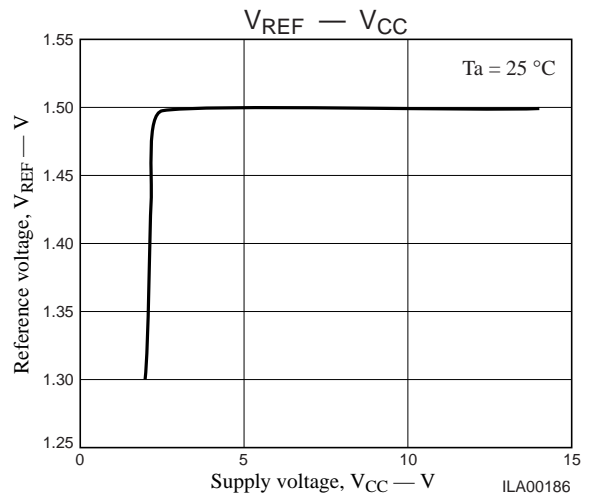
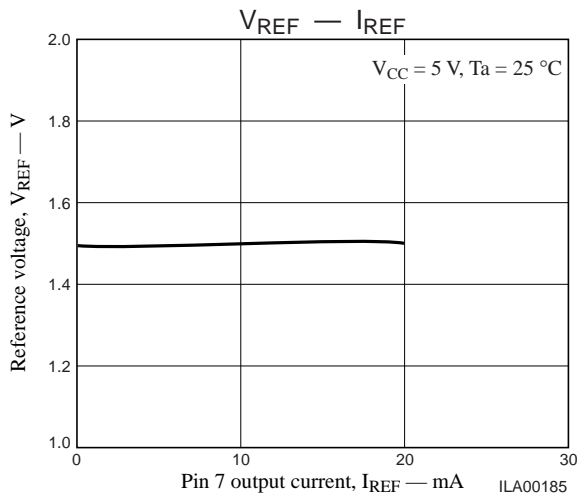
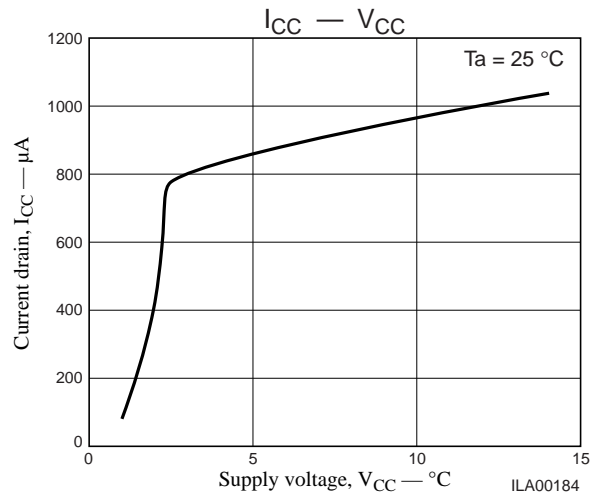
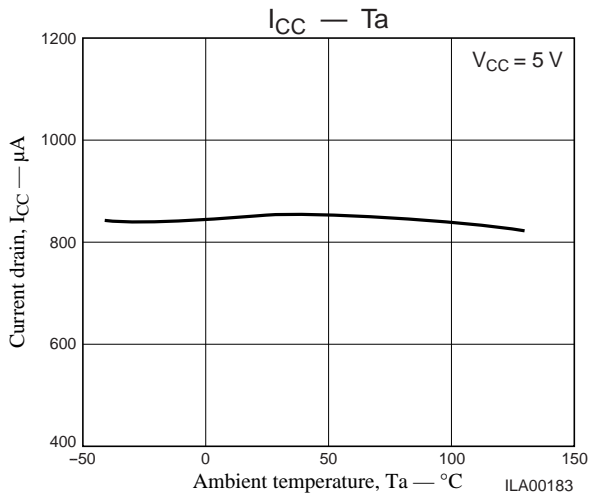

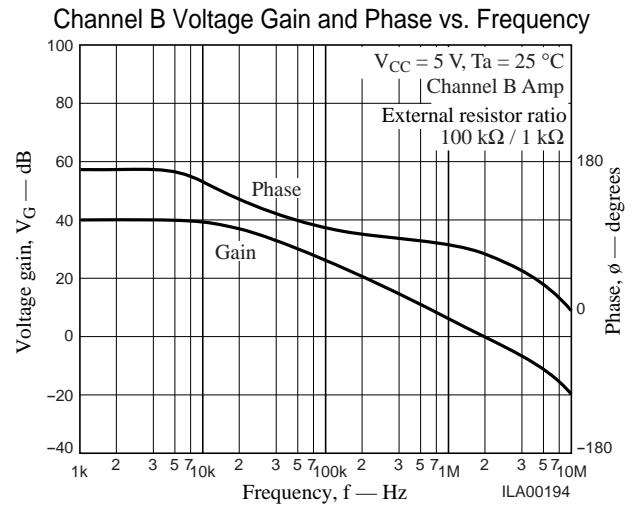
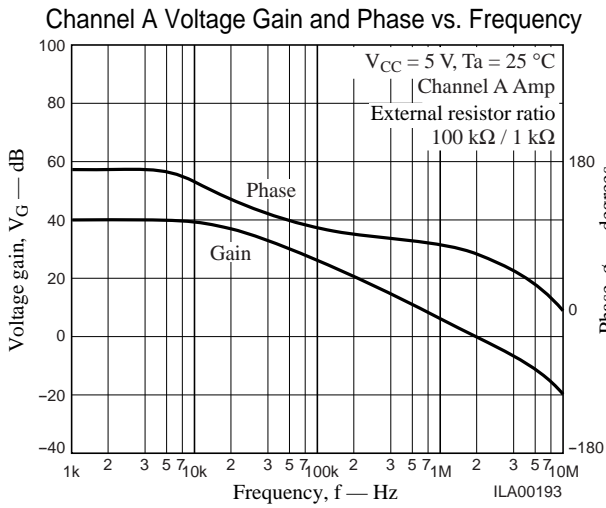
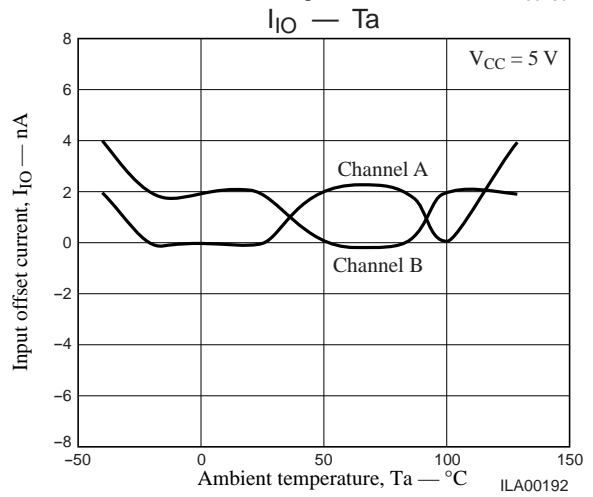
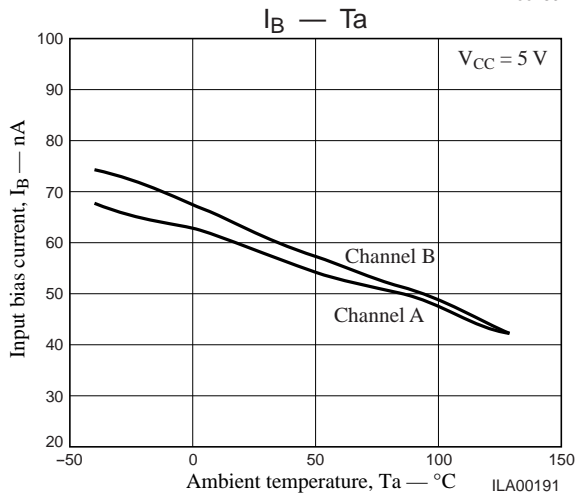
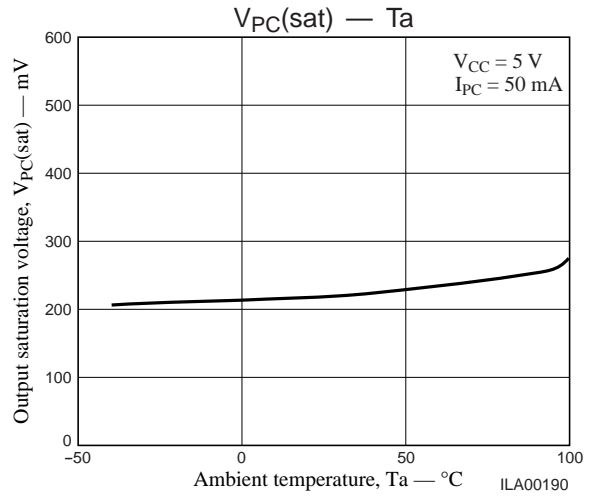
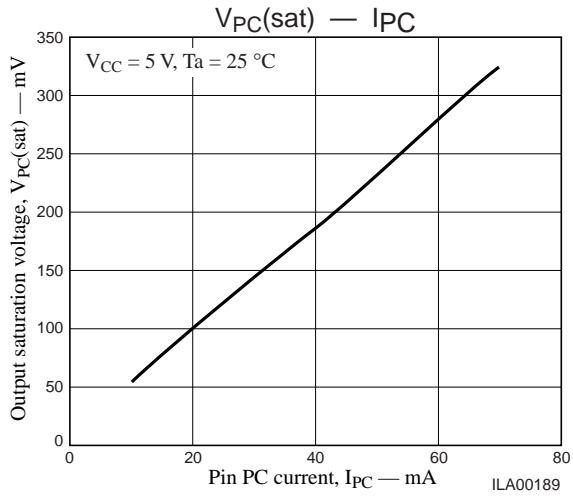

Sample Application Circuit

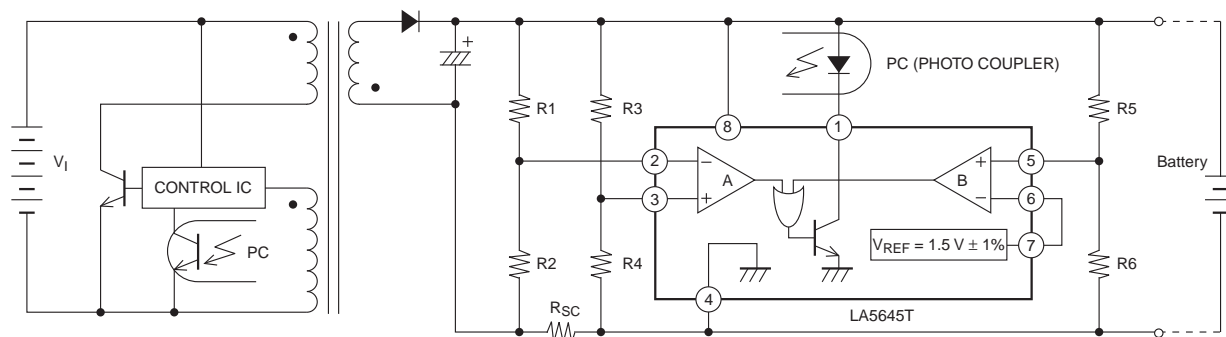

ILA00195

- Specifications of any and all SANYO products described or contained herein stipulate the performance, characteristics, and functions of the described products in the independent state, and are not guarantees of the performance, characteristics, and functions of the described products as mounted in the customer's products or equipment. To verify symptoms and states that cannot be evaluated in an independent device, the customer should always evaluate and test devices mounted in the customer's products or equipment.
- SANYO Electric Co., Ltd. strives to supply high-quality high-reliability products. However, any and all semiconductor products fail with some probability. It is possible that these probabilistic failures could give rise to accidents or events that could endanger human lives, that could give rise to smoke or fire, or that could cause damage to other property. When designing equipment, adopt safety measures so that these kinds of accidents or events cannot occur. Such measures include but are not limited to protective circuits and error prevention circuits for safe design, redundant design, and structural design.
- In the event that any or all SANYO products (including technical data, services) described or contained herein are controlled under any of applicable local export control laws and regulations, such products must not be exported without obtaining the export license from the authorities concerned in accordance with the above law.
- No part of this publication may be reproduced or transmitted in any form or by any means, electronic or mechanical, including photocopying and recording, or any information storage or retrieval system, or otherwise, without the prior written permission of SANYO Electric Co., Ltd.
- Any and all information described or contained herein are subject to change without notice due to product/technology improvement, etc. When designing equipment, refer to the "Delivery Specification" for the SANYO product that you intend to use.
- Information (including circuit diagrams and circuit parameters) herein is for example only; it is not guaranteed for volume production. SANYO believes information herein is accurate and reliable, but no guarantees are made or implied regarding its use or any infringements of intellectual property rights or other rights of third parties.

This catalog provides information as of August, 2000. Specifications and information herein are subject to change without notice.