



SANYO Semiconductors

DATA SHEET

An ON Semiconductor Company

LA4425A

Monolithic Linear IC

For Car Radio and Car Stereo

5W Power Amplifier

with Very Few External Parts

Overview

The LA4425A is a 5W power amplifier with very few external parts. The smallest package in the industry [SIP-5H(TO-126 type)]. Only two external parts (Only I/O coupling capacitors). Almost no evaluation, adjustment and check of its functions as a power IC required and simplified control

Functions

- Wide operation supply range → 5 to 16V
- On-chip protection:
 - Over-voltage protection
 - Thermal protection
 - Output D.C. short protection .
- On-chip pop noise reducing circuit

Specifications

Maximum Ratings at Ta = 25°C

Parameter	Symbol	Conditions	Ratings	Unit
Maximum supply voltage	V _{CC} max	Rg = 0	18	V
Surge maximum supply voltage	V _{CC} surge	Giant pulse 200ms Rise time 1ms	50	V
Maximum output current	I _O peak		3.3	A
Allowable power dissipation	Pd max	With infinite heat sink	7.5	W
Operating temperature	T _{opr}		-30 to +80	°C
Storage temperature	T _{stg}		-40 to +150	°C

■ Any and all SANYO Semiconductor Co.,Ltd. products described or contained herein are, with regard to "standard application", intended for the use as general electronics equipment (home appliances, AV equipment, communication device, office equipment, industrial equipment etc.). The products mentioned herein shall not be intended for use for any "special application" (medical equipment whose purpose is to sustain life, aerospace instrument, nuclear control device, burning appliances, transportation machine, traffic signal system, safety equipment etc.) that shall require extremely high level of reliability and can directly threaten human lives in case of failure or malfunction of the product or may cause harm to human bodies, nor shall they grant any guarantee thereof. If you should intend to use our products for applications outside the standard applications of our customer who is considering such use and/or outside the scope of our intended standard applications, please consult with us prior to the intended use. If there is no consultation or inquiry before the intended use, our customer shall be solely responsible for the use.

■ Specifications of any and all SANYO Semiconductor Co.,Ltd. products described or contained herein stipulate the performance, characteristics, and functions of the described products in the independent state, and are not guarantees of the performance, characteristics, and functions of the described products as mounted in the customer's products or equipment. To verify symptoms and states that cannot be evaluated in an independent device, the customer should always evaluate and test devices mounted in the customer's products or equipment.

SANYO Semiconductor Co., Ltd.

<http://semicon.sanyo.com/en/network>

LA4425A

Operating Conditions at $T_a = 25^\circ\text{C}$,

Parameter	Symbol	Conditions	Ratings	Unit
Recommended supply voltage	V_{CC}		13.2	V
Recommended load resistance	R_L		4	Ω
Operating voltage range	$V_{CC\text{ op}}$		5 to 16	V
Operating load resistance range	$R_L\text{ op}$	Under conditions where maximum ratings are not exceeded	2 to 8	Ω

Electrical Characteristics at $T_a = 25^\circ\text{C}$, $V_{CC} = 13.2\text{V}$, $R_L = 4\Omega$, $f = 1\text{ kHz}$, $R_g = 600\Omega$, specified board/specified circuit, $30 \times 30 \times 1.5\text{mm}^3$ thick aluminum used

Parameter	Symbol	Conditions	Ratings			Unit
			min	typ	max	
Quiescent current	I_{CCO}			65	130	mA
Voltage gain	V_G	$V_O = 0\text{dBm}$	43	45	47	dB
Output power	P_{O1}	$13.2\text{ V} / 4\Omega$, THD = 10%	4	5		W
	P_{O2}	$14.4\text{ V} / 4\Omega$, THD = 10%	5	6		W
Total harmonic distortion	THD	$V_O = 2\text{V}$		0.1	1.0	%
Output noise voltage	V_{NO}	$R_g = 0$, BPF = 20 Hz to 20 kHz	30	40		dB
Ripple rejection ratio	SVRR1	$R_g = 0$, BPF = 20 Hz to 20 kHz $V_R = 0\text{dBm}$, $f_R = 100\text{Hz}$	30	40		dB
	SVRR2	$R_g = 0$, BPF = 20 Hz to 20 kHz $V_R = 0\text{dBm}$, $f_R = 100\text{ Hz}$		47		dB
Over-voltage attack	V_{CCX}	$R_g = 0$		21.5		V
Starting time	t_S			0.35		s
Input resistance	R_{IN}			50		k Ω
Roll-off frequency	f_L			40		Hz
	f_H			90		kHz
Thermal operating temperature	T_c			125		$^\circ\text{C}$

Package Dimensions

unit : mm (typ)

3031C

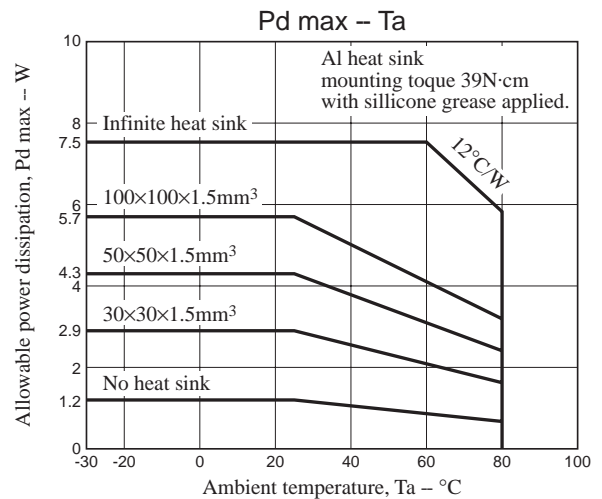
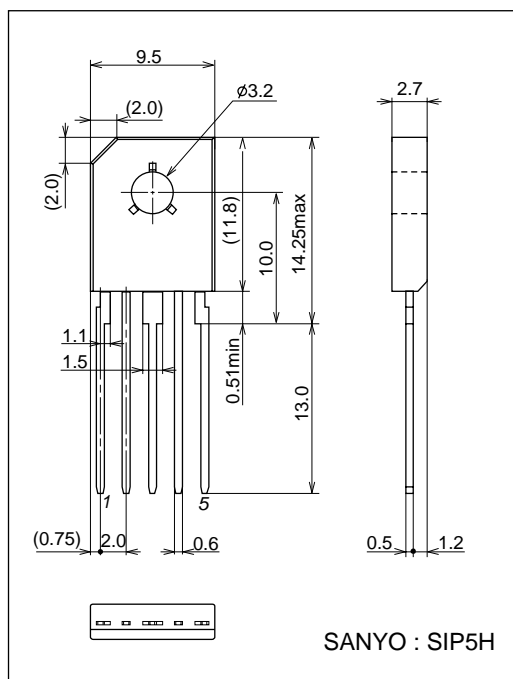

Sample Application Circuit

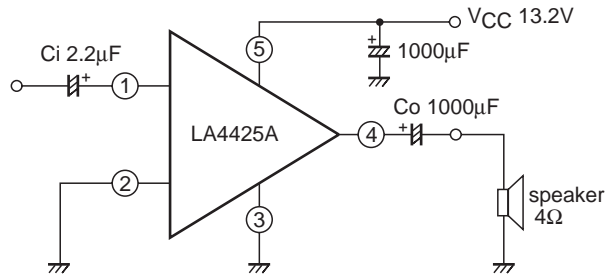

- On-chip overvoltage protection
- On-chip thermal protection
- On-chip pop noise reducing circuit
- On-chip output D.C. short protection

Pin Voltage at $V_{CC} = 13.2V$

Characteristics	Input	Small signal GND	Large signal GND	Output	V_{CC}
Pin No.	1	2	3	4	5
Pin voltage (reference value)	$(\approx 2V_{BE})$ 1.4V	0V	0V	$(\approx 1/2V_{CC})$ 6.5V	(V_{CC}) 13.2V

IC Usage Notes

Maximum ratings

If the IC is used in the vicinity of the maximum ratings, even a slight variation in conditions may cause the maximum ratings to be exceeded, thereby leading to a breakdown.

Printed circuit board

When drawing the printed circuit pattern, refer to the sample printed circuit pattern. Be careful not to form a feedback loop between input and output.

Comparison of External Components

External Parts	Our ICs now in use	LA4425A
Output coupling capacitor	○	○
Input coupling capacitor	○	○
Bootstrap capacitor	○	-
Feedback capacitor	○	-
Filter capacitor	○	-
Phase compensation capacitor	○	-
Oscillation correction polyester film capacitor	○	-
Oscillation correction resistor	○	-
Total	8 pcs.	2 pcs.

Note: The power supply capacitor is not counted as a power IC part.

LA4425A

Sample Printed Circuit Pattern

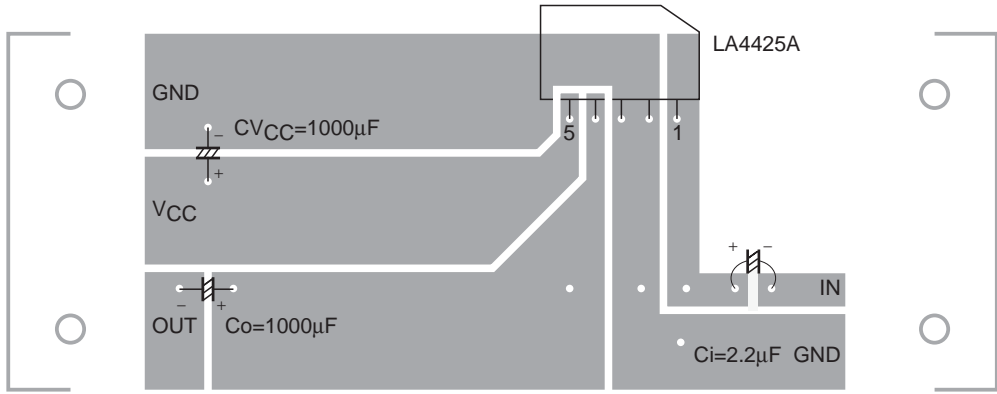

Cu-foiled side 78.0x29.0mm²

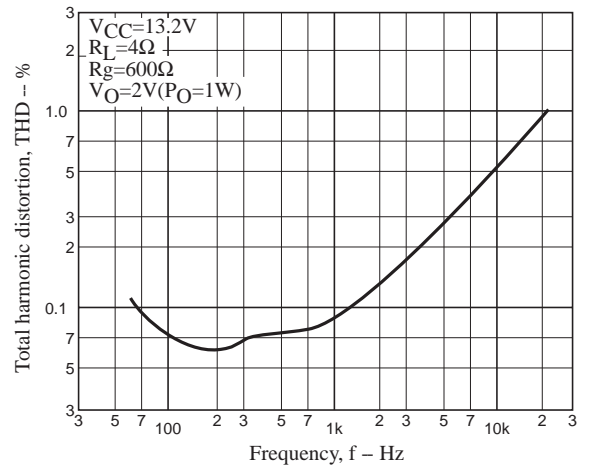
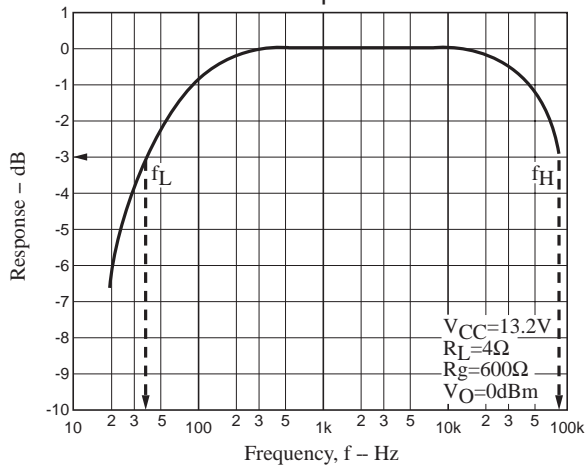
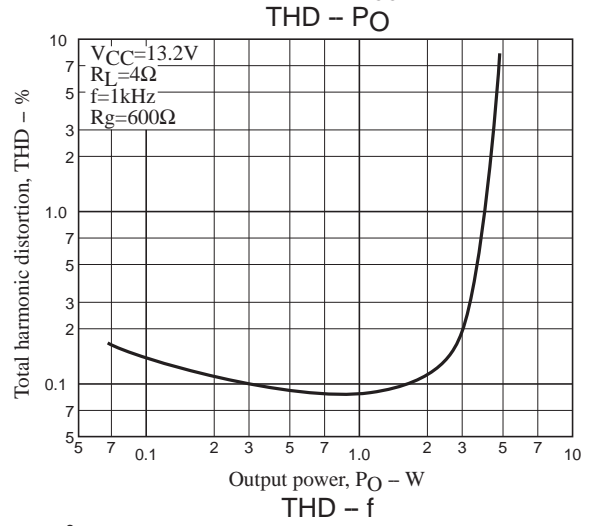
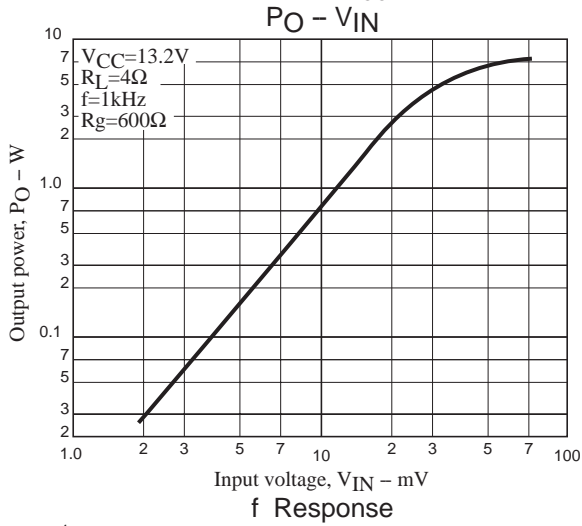
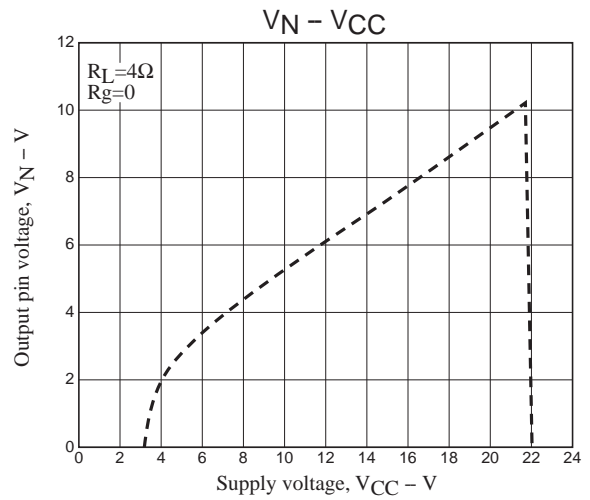
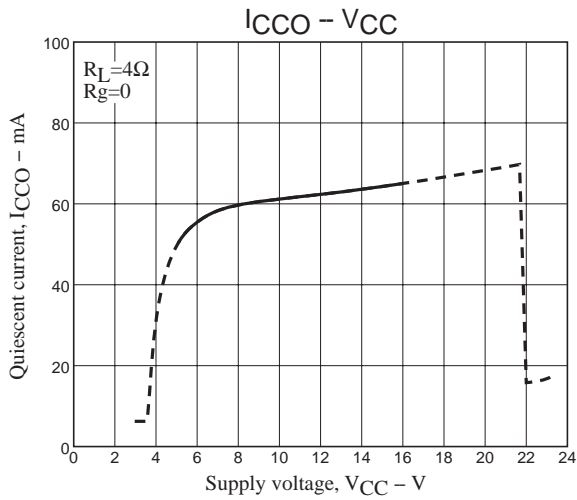

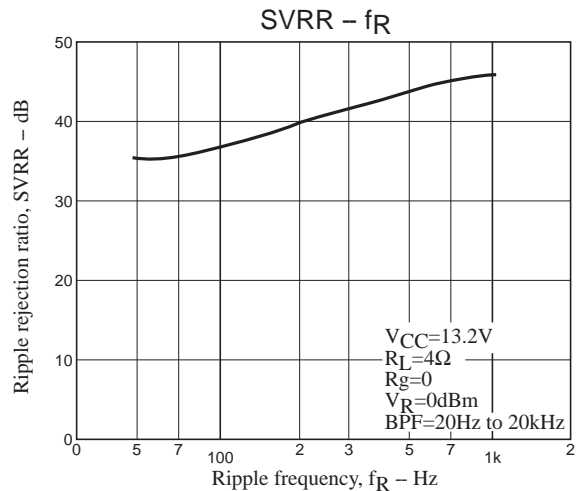
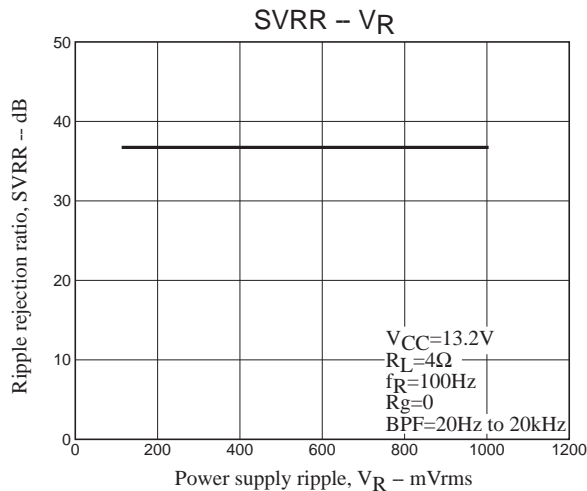
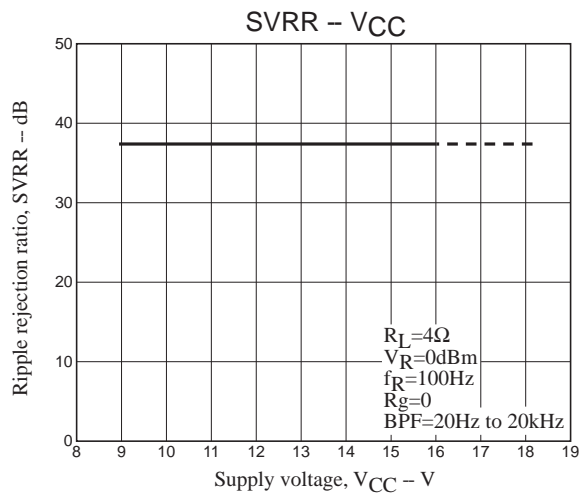
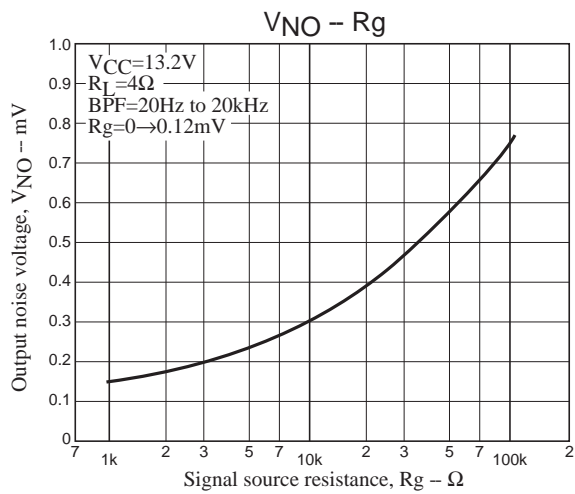
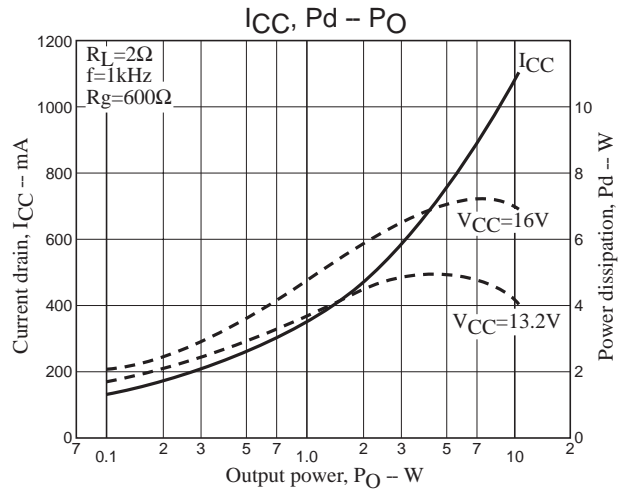
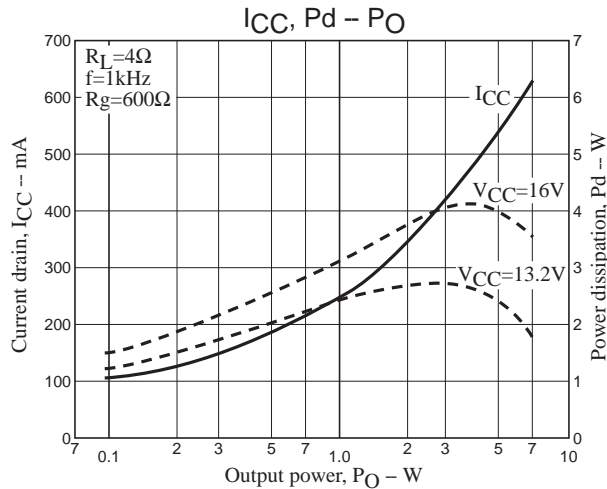
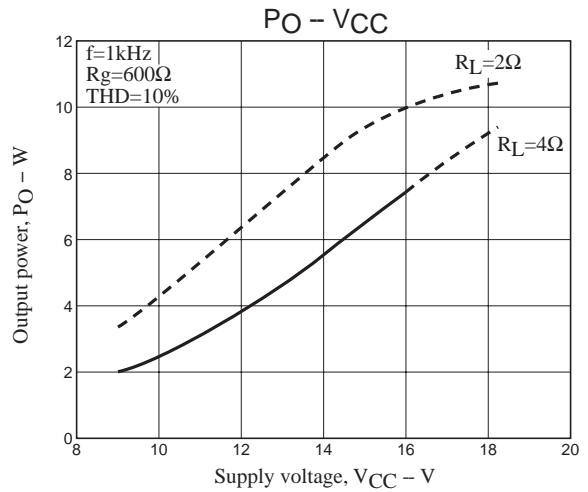
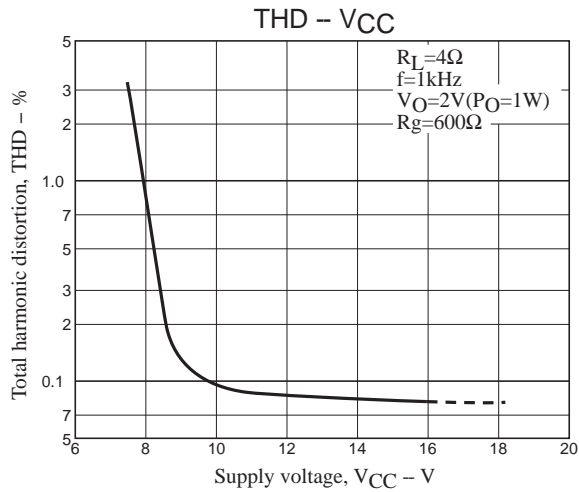

LA4425A

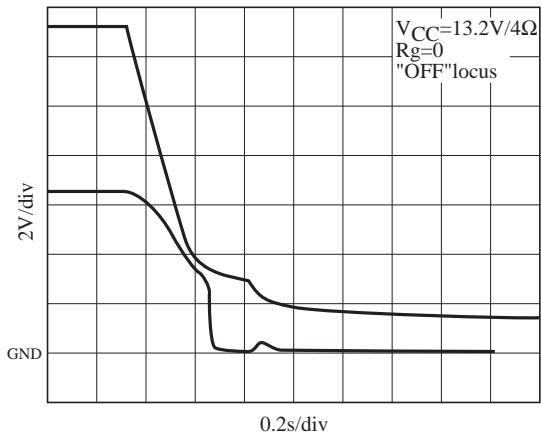
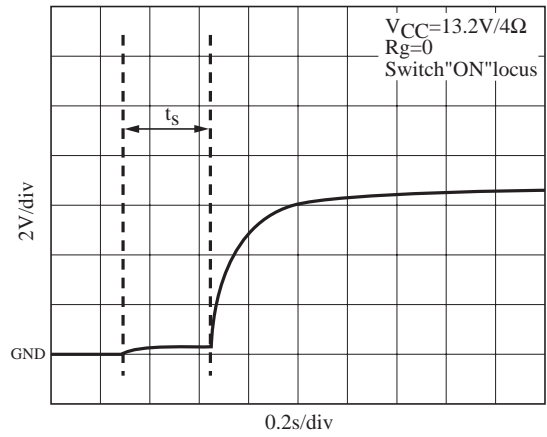
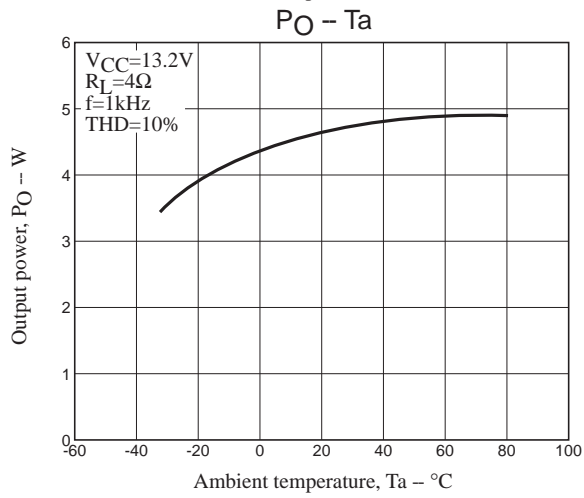
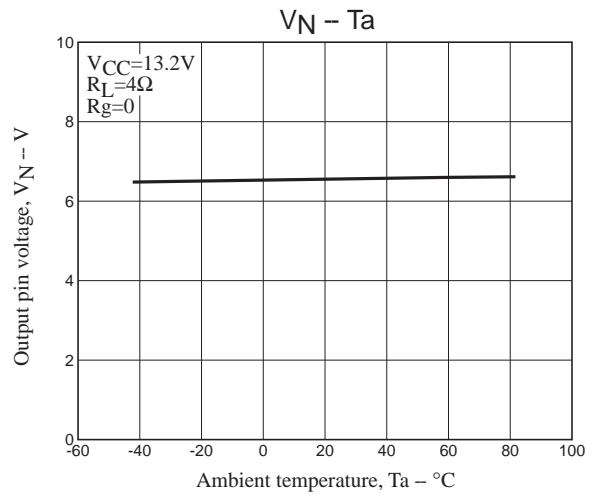
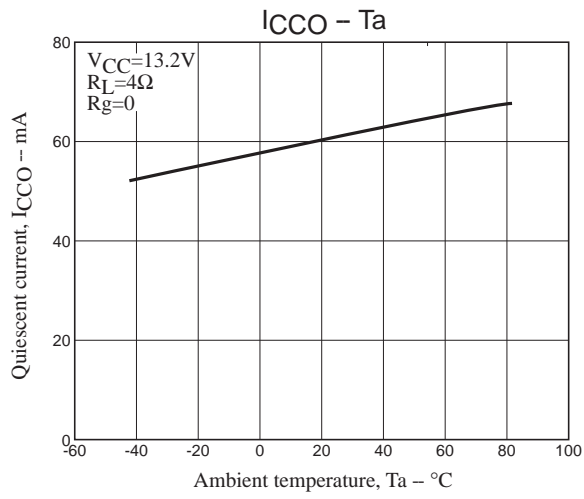

LA4425A

Instructions and Precautions

- Connect a capacitor of 1000pF across pins ① and ② for external disturbance path.
- Be careful of the ground line artwork when laying out the printed circuit pattern. Arrange so that the Sg route and load current flow-in route do not overlap. Refer to the recommended printed circuit pattern or make slits, etc. at pins ② and ③.

DUAL Printed Circuit Pattern Example

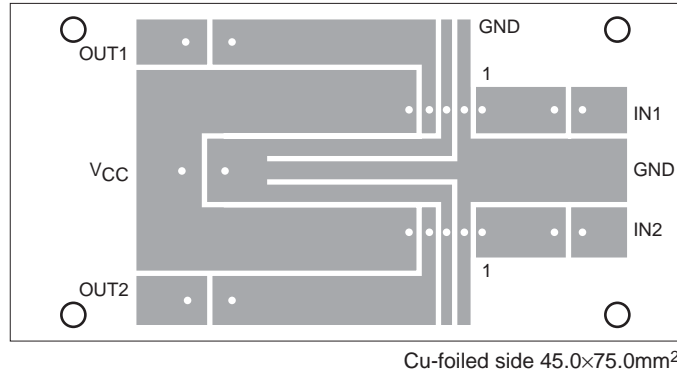

• Short Circuit Tests

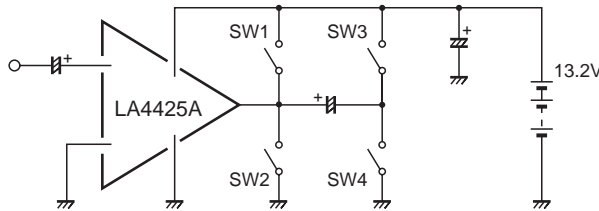

SANYO Semiconductor's recommended printed circuit board: Apply $V_{CC}=13.2V$ using a $30 \times 30 \times 1.5mm^3$ thick aluminum board. The IC will be protected from the DC/AC shorting of switches 1 to 4 above. However, be careful not to damage the IC by turning V_{CC} "ON" when DC short (SW 1 or SW 2) is on.

• Power Supply Positive Surge

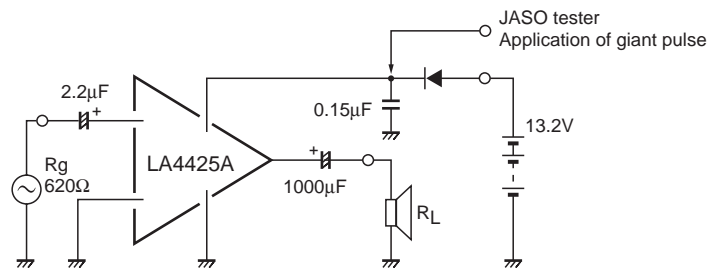

The over-voltage protector ($V_{CCX} \approx 21.5V$) inside the IC is used to cut all bias routes and reverse bias between B-E of output stage elements, in order to increase the power line's capability of handling positive surge. This means, of course, that a V_{CES} (V_{CBO}) type output stage element is used instead of the V_{CEO} (V_{CER}) type.

LA4425A

- Load Resistance and Misoperation

It should be noted that when $R_L < 2\Omega$ and V_{CC} is high, and the switch is turned “ON” when setting is for a signal (THD = 10%), the ground detector (current \times voltage Schmitt circuit) operates momentarily.

- Precautions on TaB

If power voltage is applied to the IC substrate (the heat sink on a set), the IC structure is such that the PN junctions may be burned, causing deterioration or destruction. Consult SANYO Semiconductor’s Quality Assurance Department with regard to the energy handling capability (voltage peak value, pulse width). Also, the IC TaB (substrate) is connected to pin 3, large signal GND.

- Test of +V_{CC} to Output Pin

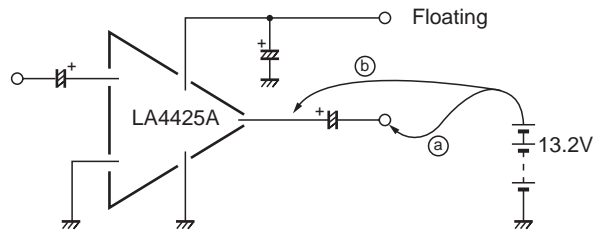

The power pin is in a floating state when a power capacitor is connected, so if +V_{CC} touches output lines (a) and (b), the upper power transistor inside the IC will be damaged.

The LA4425A has a protective bypass route inside the IC.

- Starting Time (t_s)

This is set at 0.35sec/typ, but it can be made shorter by making input capacitor C_i smaller, or longer by making it larger.

- Pop noise

The pop noise prevention circuit operates to reduce pop until R_g reaches 50k Ω . However, if R_g is left open, the charging route of input capacitor C_i is lost, so the pop noise reduction circuit stops operating and click noises become louder.

- VG/OSC

The voltage gain is fixed at 45dB inside the IC. It is impossible to change it externally.

Phase compensation capacitors (350pF/total) are connected between individual stages inside the IC, and the open loop gain is low. In addition, the upper and lower drives are made equivalent so that final stage current gain is adjusted, providing a measure against unwanted high-frequency parasitic oscillation peculiar to power IC’s.

- BTL Connection

Connection is impossible with IC alone.

- Reverse Mounting of IC

The pin assignment is such that there is no danger of damage.

- T.S.D (Thermal Shutdown) Operating Temperature

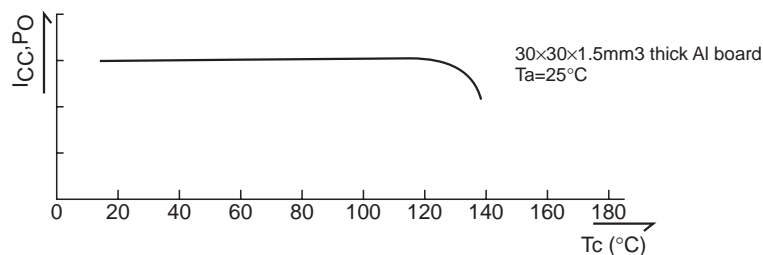

T.S.D is capable of starting operation at Tc 120 to 130°C. When this is converted to junction temperature (Tj) according to the formula below.

$$T_j \approx 165C,$$

$$T_j = Q_{jc} \cdot P_d + T_c$$

As T.S.D operation progresses, the output pin bias voltage drops, and it becomes harder to drive the upper waveform. Therefore, the current (I_{CC}) and power (P_O) show a tendency to decrease.

Proper Cares in Mounting Radiator Fin

1. The mounting torque is in the range of 1. The mounting torque is in the range of 39 to 59 N·cm.
2. The distance between screw holes of the radiator fin must coincide with the distance between screw holes of the IC.
3. The screw to be used must have a head equivalent to the one of truss machine screw or binder machine screw defined by JIS. Washers must be also used to protect the IC case.
4. No foreign matter such as cutting particles shall exist between heat sink and radiator fin. When applying grease on the junction surface, it must be applied uniformly on the whole surface.
5. Because the heat sink mounting tab and the heat sink are at the same electric potential as the chip's GND, care must be taken when mounting the heat sink on more than one device.
6. IC lead pins are soldered to the printed circuit board after the radiator fin is mounted on the IC.

- SANYO Semiconductor Co.,Ltd. assumes no responsibility for equipment failures that result from using products at values that exceed, even momentarily, rated values (such as maximum ratings, operating condition ranges, or other parameters) listed in products specifications of any and all SANYO Semiconductor Co.,Ltd. products described or contained herein.
- SANYO Semiconductor Co.,Ltd. strives to supply high-quality high-reliability products, however, any and all semiconductor products fail or malfunction with some probability. It is possible that these probabilistic failures or malfunction could give rise to accidents or events that could endanger human lives, trouble that could give rise to smoke or fire, or accidents that could cause damage to other property. When designing equipment, adopt safety measures so that these kinds of accidents or events cannot occur. Such measures include but are not limited to protective circuits and error prevention circuits for safe design, redundant design, and structural design.
- In the event that any or all SANYO Semiconductor Co.,Ltd. products described or contained herein are controlled under any of applicable local export control laws and regulations, such products may require the export license from the authorities concerned in accordance with the above law.
- No part of this publication may be reproduced or transmitted in any form or by any means, electronic or mechanical, including photocopying and recording, or any information storage or retrieval system, or otherwise, without the prior written consent of SANYO Semiconductor Co.,Ltd.
- Any and all information described or contained herein are subject to change without notice due to product/technology improvement, etc. When designing equipment, refer to the "Delivery Specification" for the SANYO Semiconductor Co.,Ltd. product that you intend to use.
- Information (including circuit diagrams and circuit parameters) herein is for example only; it is not guaranteed for volume production.
- Upon using the technical information or products described herein, neither warranty nor license shall be granted with regard to intellectual property rights or any other rights of SANYO Semiconductor Co.,Ltd. or any third party. SANYO Semiconductor Co.,Ltd. shall not be liable for any claim or suits with regard to a third party's intellectual property rights which has resulted from the use of the technical information and products mentioned above.

This catalog provides information as of May, 2007. Specifications and information herein are subject to change without notice.