

SANYO

No.1408E

LA3430

PLL FM MPX STEREO DEMODULATOR
WITH PILOT CANCELER FOR CAR STEREO USE

The LA3430 is an MPX IC for FM car stereo use. It contains the VCO non-adjusting function, skip noise eliminating function, and pilot cancel function and is packaged in a 16-pin SEP.

Functions

- . VCO non-adjusting function
- . Pilot cancel function (Level follow-up type)
- . Stereo noise control function (SNC function)
- . High cut control function (HCC function)
- . Stereo - monaural automatic select (Pilot input prioritized)
- . VCO oscillation stop function
- . Forced monaural function for reception mode (Stereo lamp unlighted, pilot cancel function and HCC function held).

This function is provided by disconnecting pin 10 from V_{CC} .

How to provide forced monaural mode at stereo reception	Lamp	HCC	Pilot cancel
Pin 8 GND	Lighted	o	o
7.3V or greater applied to pin 7	Unlighted	x	x
Pin 11 GND	Unlighted	o	x
Pin 10 disconnected	Unlighted	o	o

Features

- . Non-adjusting VCO: Eliminates the need to adjust free-running frequency.
- . VCO is stable to ambient temperature changes: ± 0.1 to 0.15% for $\pm 50^\circ\text{C}$ change
- . Low distortion (0.07% typ./300mV input, mono)
- . Good ripple rejection of power supply (35dB typ.)
- . Wide operating voltage range ($V_{CC}=6.5$ to 13V)
- . Good space factor due to single-end package
- . Easy to draw printed circuit pattern due to pin-to-pin space of 3mm.

Package Dimensions (unit: mm) 3020A

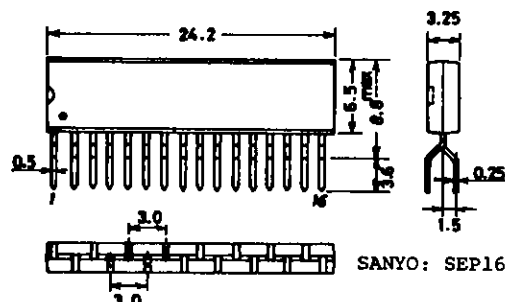

SANYO Electric Co., Ltd. Semiconductor Business Headquarters
TOKYO OFFICE Tokyo Bldg., 1-10, 1 Chome, Ueno, Taito-ku, TOKYO, 110 JAPAN

D177KI/3066KI/5175MW/8044KI, TS/9233KI, MT No.1408-1/13

LA3430

Maximum Ratings at Ta=25°C			unit	
Maximum Supply Voltage	V _{CCmax}		16	V
Lamp Driving Current	I _{Lmax}		30	mA
Allowable Power Dissipation	P _{dmax}	Ta ≤ 45°C	520	mW
Operating Temperature	Topr		-20 to +70	°C
Storage Temperature	Tstg		-40 to +125	°C

Operating Conditions at Ta=25°C			unit	
Recommended Supply Voltage	V _{CC}		10	V
Operating Voltage Range	V _{CC op}		6.5 to 13	V
Recommended Input Signal Voltage	V _i		200 to 300	mV

Operating Characteristics at Ta=25°C, V_{CC}=10V, V_i=300mV, f=1kHz, L+R=90%, pilot=10%

			min	typ	max	unit
Quiescent Current	I _{cco}	No input		28	38	mA
Channel Separation	Sep		40	50		dB
Total Harmonic Distortion	THD	Monaural		0.07	0.2	%
		Main		0.07	0.2	%
Lamp Lighting Level	V _L	L+R=90%, pilot=10%	60	85	120	mV
Lamp Hysteresis	h _y			3	6	dB
Capture Range	CR			±1		%
Output Signal Level	V _o	Sub	150	215	300	mV
Signal to Noise Ratio	S/N	R _g =20kohms	68	74		dB
		R _g =10kohms	70	78		dB
Input Resistance (Pin 2)	r _i			20		kohm
SCA Rejection	SCA rej			80		dB
Allowable Input Voltage	V _i	THD=1%, R _g =20kohms	700	900		mV
		THD=1%, R _g =10kohms		450		mV
SNC Output Attenuation	Att SNC	V ₈ =0.6V, L-R=90%, pilot=10%	-8.5	-3.0	-0.3	dB
SNC Output Voltage	V _{o sub}	V ₈ =0.1V, L-R=90%, pilot=10%			5	mV
HCC Output Attenuation	Att HCC(1)	V ₇ =0.6V, L+R=90%, pilot=10%	-15.0	-6.0	-0.5	dB
	Att HCC(2)	V ₇ =1V, L+R=90%, pilot=10%	-2.0		0	dB
Ripple Rejection of Power Supply	R _r			35		dB
V _{CO} Stop Voltage				7.3		V
Channel Balance				0.5	1.5	dB
Pilot Cancel			20	27		dB
Stereo Lamp Current		Minimum stereo operating current	1.0			mA
Saturation Voltage (Pin 10)		I _L =10mA		1.0		V

Specified Test Circuit

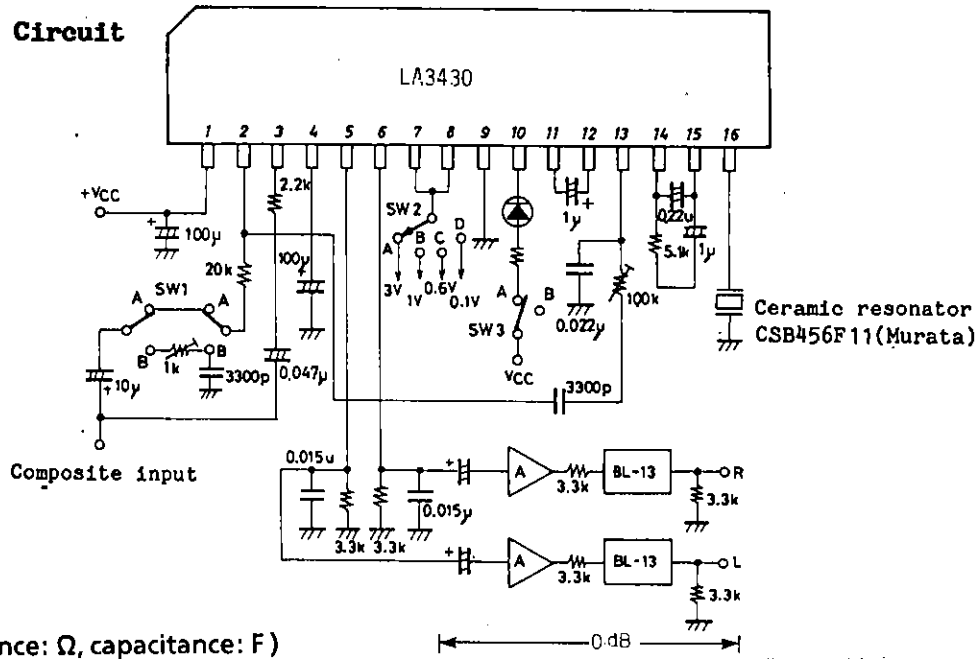

Unit (resistance: Ω, capacitance: F)

Band width=100kHz,
THD=0.01% or less, input
impedance=330kohms or greater

SW1: For characteristics other than separation,
place in the A position.

SW2: For characteristics other than HCC, SNC,
place in the A position.

SW3: Forced monaural of reception mode

Sample Application Circuit 1

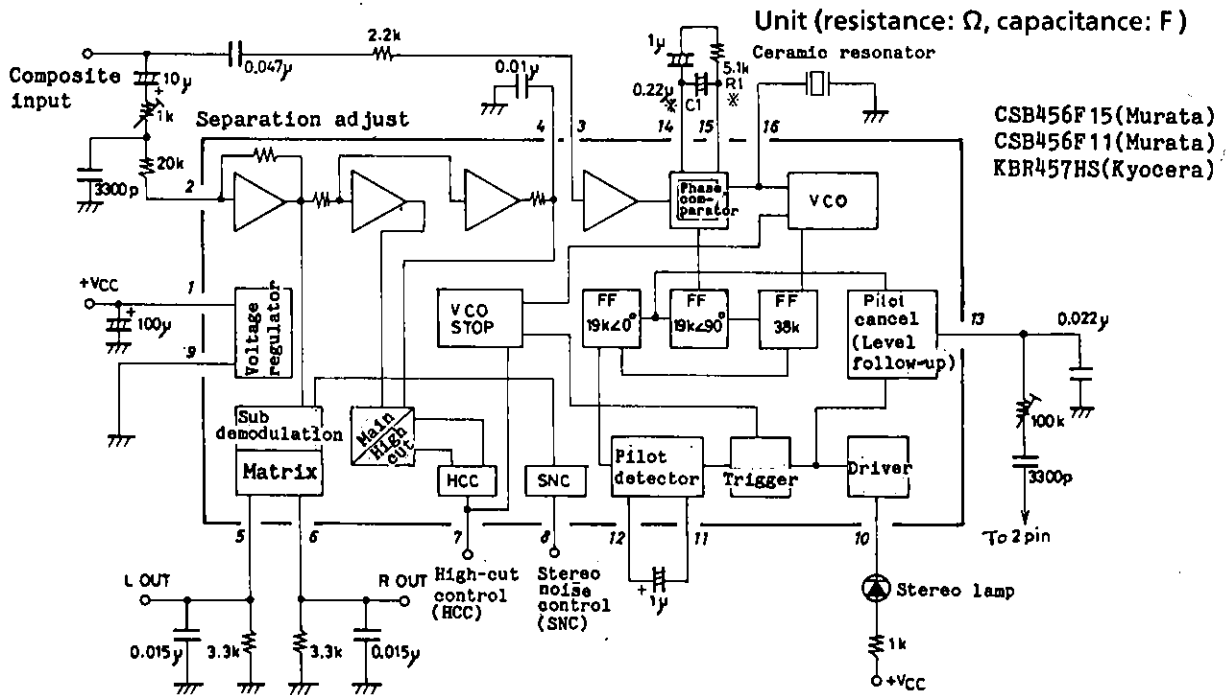

Note 1: The voltage applied to pin 10 must not exceed the voltage applied to pin 1.

*: When the LA1260 is used for the FM IF IC, R1 is 10kohms and C1 is 0.1µF. (Extension in capture range)
(This also applies when an FM IF IC with a demodulation output similar to that of the LA1260 is used.)

Sample Application Circuit 2: Combination of LA2110 and LA3430

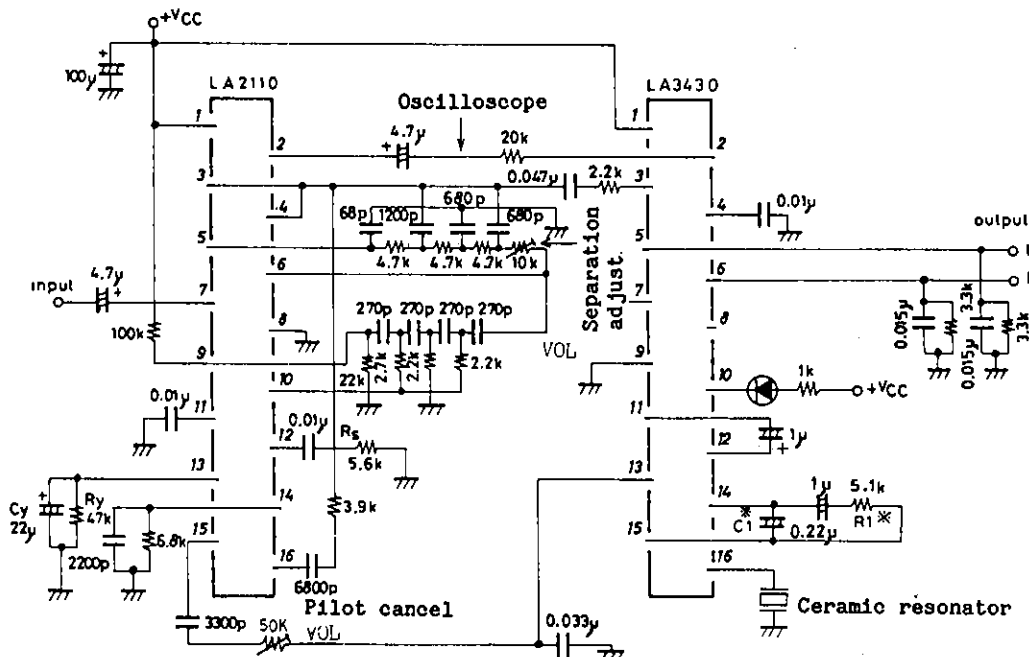

Note 1: The voltage applied to pin 10 must not exceed the voltage applied to pin 1.

*: When the LA1260 is used for the FM IF IC, R1 is 10kohms and C1 is 0.1uF. (Extension in capture range)
 (This also applies when an FM IF IC with a demodulation output similar to that of the LA1260 is used.)

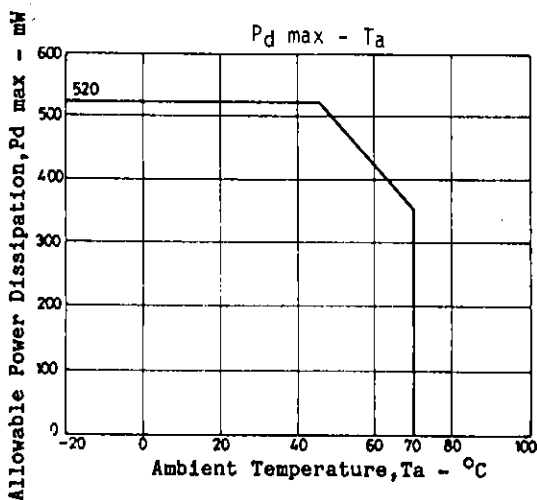

Ceramic resonator

The ceramic resonator to be used with the LA3430 must be as specified. The following are the Type Nos. of the specified ceramic resonators, their suppliers, and section to which inquiries should be made.

CSB456F11	Murata	Piezoelectric Division
CSB456F15		TEL: 0762-40-2381
KBR457HS	Kyocera	Electronic Division
		TEL: 075-592-3851

Cautions when employing sample application circuits

- . Adjust separation by 10kohm potentiometer in low pass filter.
- . Adjust R_s for noise detection sensitivity under strong to medium radio fields. Set at adequate value.
- . Adjust noise AGC by C_Y and R_Y to enhance noise suppression in medium to weak radio fields.
- . Adjust pilot cancellation by 50kohm potentiometer connected to pin 15 of the LA2110.
- . Response speeds of pilot cancellation to follow levels can be varied by adjusting capacitance value of 1uF capacitor connected across pins 11 and 12 of the LA3430. Distortion factors deteriorate with reduction in value.
- . Adjusting pilot cancellation

For example consider the sample application circuit 2. Assume the input signal consists only of pilot signals. First connect an oscilloscope and a valve voltmeter to pin 2 of the LA2110. Set their ranges for V: 200mV/div. AC,H: 20usec/div.

When oscilloscope waveform is  or

turn pilot cancel control to change it to the following.



Then, adjust pilot cancel control to minimize indications of valve voltmeter.

When the LA3430 alone is used (sample application circuit 1), adjust cancel control through a 19kHz B.P.F. to minimize carrier leakage level at output pins (pins 5 and 6).

1. Pilot cancelling circuit

A level-following type has been used. Once set, it can easily accommodate varying pilot modulation depths among stations. Cancelling signal is a sawtooth wave obtained by integrating a square wave that is proportionate in amplitude to pilot level with C and R.

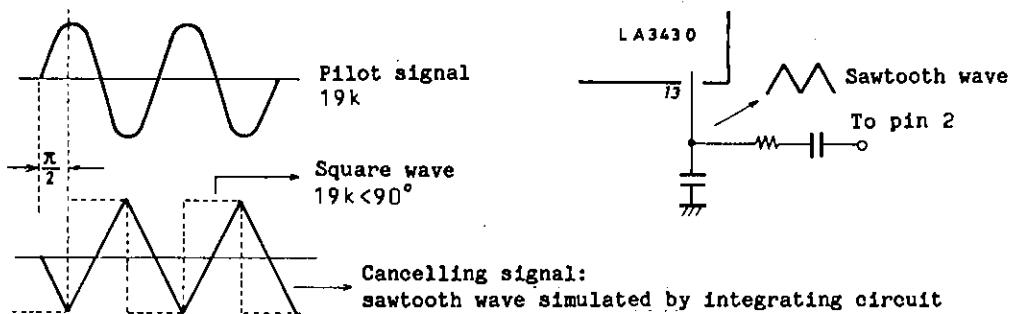

2. Separation adjustments

The LA3430 has separation parameters that have been set to provide maximum separation when used in conjunction with the LA2110, a noise-canceller IC, or the equivalent. The LA3430 by itself exhibits separation only in a 25 to 30dB range. If a phase correction circuit is provided in the LA3430 input circuit, it can exhibit intrinsic separation characteristics, typically 50dB.

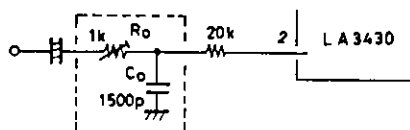

Phase correction circuit

3. SNC (stereo noise control) and HCC (high-cut control)

The LA3430 has SNC and HCC terminals for improved S/N ratios when operating in weak radio fields. By adjusting the SNC terminal, noises unique to stereo FM in weak fields can be reduced. The HCC terminal permits further improvement of effective S/N ratios by lowering treble levels of FM noises in weak fields. (See Fig.2.)

STEREO deteriorates approximately 21.7dB (compared to MONO) in weak radio fields (Fig.2). Generally, when S/N ratios deteriorate below 30 to 40dB, noises become quite noticeable. Section (1) shows ways to set SNC and HCC when radio field strengths are divided into 3 regions, A, B, and C, (Fig.2). SNC is expected to function in region A, and HCC in region B. In region C, shallow muting is effected in the IF stage.

(1) SNC (stereo noise control)

Stereo S/N ratios deteriorate 21.7dB below monaural but can be improved by varying stereo separation. S/N improvement becomes apparent, however, only when the separation is 20dB or worse. In that case, the relation between separation and S/N improvement is shown in Fig.5.

SNC in the LA3430 improves S/N ratios in weak radio fields by varying separation. It varies subsignal demodulation level and controls separation. By using the IF stage signal meter level output as the source of the control signal, S/N ratios in region A of Fig.2 can be maintained at about 40dB or better. Ideal S/N enhancements should provide gradual switching over from stereo to monaural to maintain constant S/N ratios, starting from a point in region A for 40dB stereo S/N toward a point for 40dB monaural S/N. Methods to set the control level will be described later.

Fig.3 shows separation characteristics (SNC characteristics) for voltages applied to pin 8 (SNC terminal) of the LA3430. Pin 8 is also the base of a PNP transistor, so stereo mode is set when pin 8 is open and monaural mode is set when it is grounded. SNC terminal control is effective only when locked with pilot signals and when stereo indicator is lit. External circuit parameters can be chosen in large values that do not affect the IF stage meter output circuit because SNC control currents are small. This makes designing easy. (See Fig.6.)

(2) Designing external circuits for SNC characteristics (characteristic setting by drawing)

We recommend the following as a way to designate SNC characteristics to have smooth transition of separation from stereo monaural in region A of Fig.2.

Separation vs. S/N enhancement relation Refer to Fig.5.

SNC terminal voltages vs. separation characteristics Refer to Fig.3.

Antenna inputs vs S/N improvement characteristics can be obtained from the drawing if the graph for IF stage signal meter output vs. antenna input and the graph for stereo S/N ratio vs. antenna input are known. From desired S/N characteristics, SNC terminal voltage characteristics can also be obtained. Sample drawings are shown in Fig.4, where for simplicity's sake, SNC, IF meter, and stereo S/N characteristics have been approximated with straight lines.

For instance:

To obtain stereo S/N improvement characteristics from SNC characteristics, when (a) in the second quadrant of the chart represents bare SNC characteristics, point 1 projected to the third quadrant shows a 20dB

Continued on next page.

Continued from preceding page.

separation and a 1dB S/N improvement. When projected from the first to the fourth quadrant, a point improved by 1dB in S/N over the stereo S/N line in the fourth quadrant corresponds to point 1. Similarly, point 2 on the SNC characteristics in the second quadrant corresponds to point 2 in the fourth quadrant. Point 3 in the second quadrant corresponds to point 3 in the fourth quadrant. Stereo S/N improvement characteristics for each point are obtainable.

Similarly, (b) characteristics in the second quadrant are projected to form (b) characteristics in the fourth quadrant, and (c) in the second quadrant to form (c) in the fourth quadrant, thus providing a way to diagram improvement characteristics.

In the resulting drawings, ideal S/N improvement characteristics are similar to (b) in the fourth quadrant, but corresponding SNC characteristics have to be (b) characteristics in the second quadrant which are difficult to realize. Among realistic characteristics, something like (c) appears to be satisfactory. The (c) SNC characteristics are obtained with a shift by two diodes together with a 1/2 bleeder.

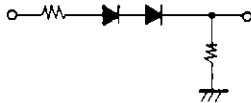

(3) HCC (high-cut control)

In region B where S/N deteriorates to 40dB or worse even for monaural, the S/N as sensed by the human ear can be enhanced by suppressing levels at frequencies above approximately 7kHz. Treble region levels that follow meter voltages can be smoothly attenuated (high-cut control) by impressing IF stage signal meter output to the HCC pin (pin7) of the LA3430. Fig.7 shows MPX output frequency characteristics (monaural) provided by voltage impressed on pin 7. Frequency characteristics for a 100% high cut can be designated by an external capacitor connected to pin 4. An equivalent circuit is shown below where the designation is made by the 5kohms and the C time constant. Approximate values provided by C as expressed in attenuation at 10kHz are listed in table below: right.

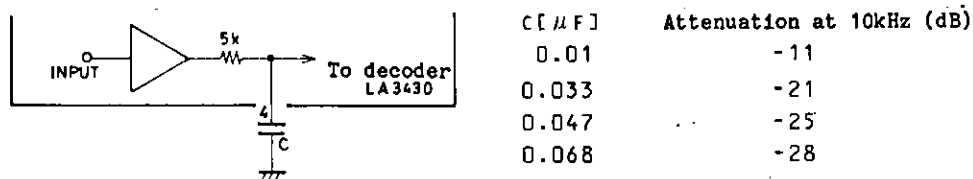
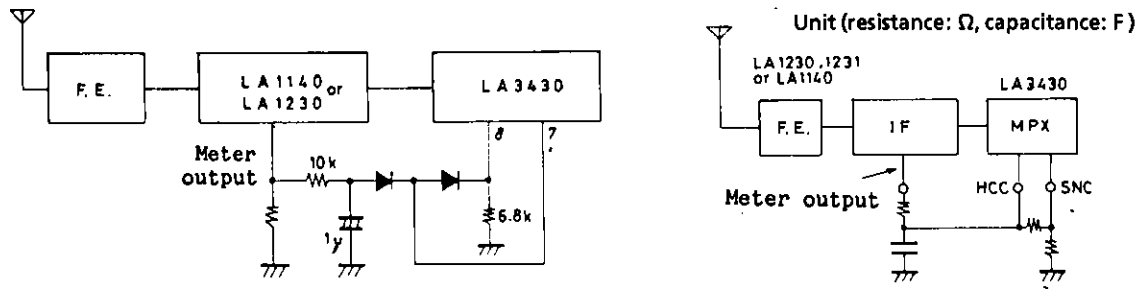

Fig. 8 shows the relation between voltages impressed on pin 7 and rates (%) of high cut (HCC). When IF meter output voltage characteristics and region B, S/N characteristics, of Fig. 2 have been obtained, S/N improvement by HCC can be drawn in a way similar to drawing SNC characteristics.

Fig.2 shows typical meter outputs of a quadrature detection IF amplifier IC. (Fig. 1 shows data for LA1140, LA1230, and LA1231N) HCC characteristics have been designated to permit region B improvements when the IC is directly connected to HCC (pin 7) terminal of the LA3430. The infinitesimal control currents at pin 7, similar to pin 8, do not affect meter outputs.

- (4) SNC and HCC connection circuits when coupled with the IF stage
 Fig. 1 shows sample S/N characteristics vs. antenna inputs when SNC and HCC are connected with the IF stage by an external circuit.



- (5) S/N improvements in region C of Fig.1
 Because S/N ratios deteriorate even further in the region C of Fig. 1, it is better to improve the S/N in this region with IF mutings. The LA1140 is available to linearly vary the IF muting. Employment of the LA3430 together with the LA1140 further enhances S/N improvement.
- (6) Using the HCC terminal for muting
 Mutings in the neighborhood of 37dB are feasible by utilizing HCC functions as muting functions when used in home stereos and no need exists to suppress treble noises. Fade-in and fade-out of mutings, permitting delightful, shock-noise-free muting, are possible by providing a time constant to the pin 7 control.

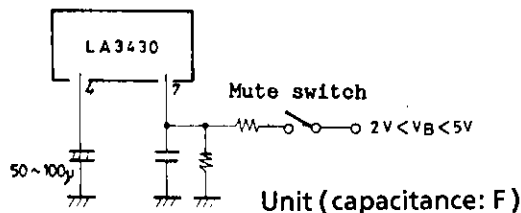

- (7) VCO damping
 VCO oscillations can be damped by applying a voltage not less than 7V to the HCC terminal (pin 7) to induce a monaural mode. At this time, both SNC and HCC are in an off mode. Fig. 9 shows flow-in current by voltages applied to pin 7.
- (8) Forced monaural
 By disconnecting LED lamp at pin 10 from V_{CC} lamp, reception mode forced monaural function can be attained. (Stereo lamp is turned OFF. Pilot cancel and HCC function are held.)

Sample weak radio field S/N improvements by the system (Fig.1)

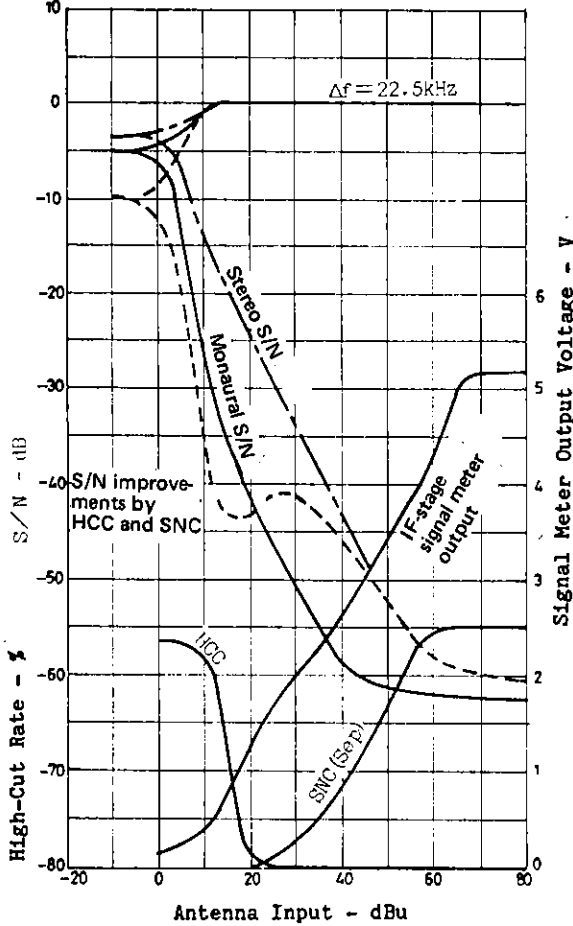

SNC and HCC Operating Regions (Fig.2)

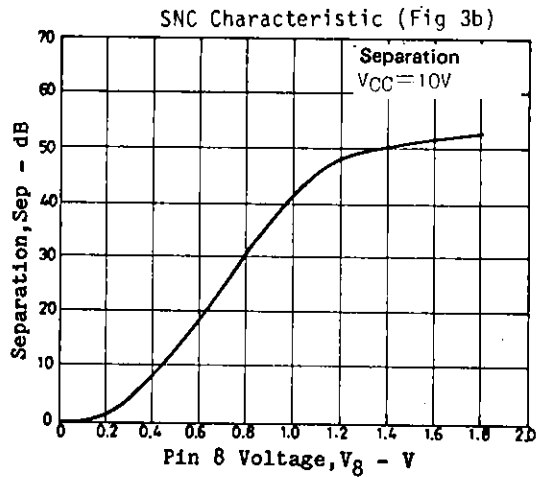
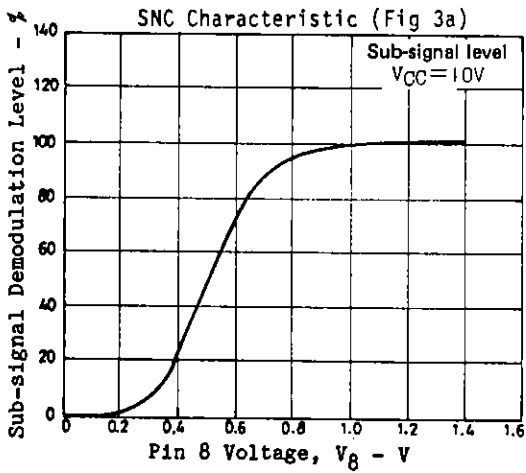
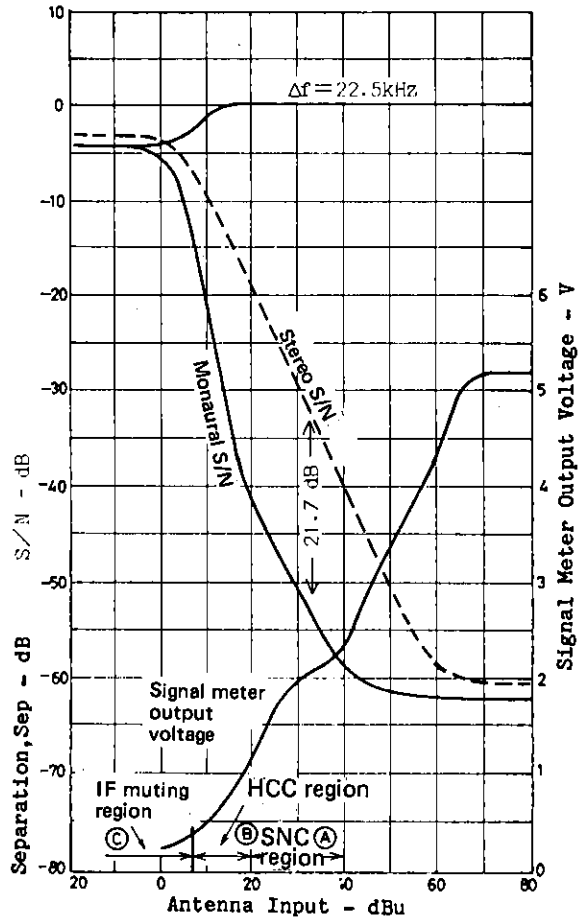
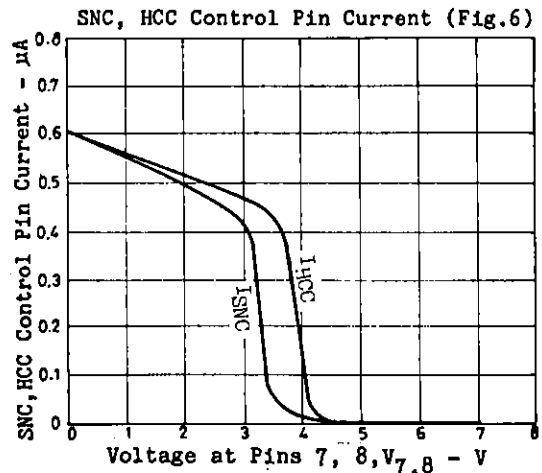
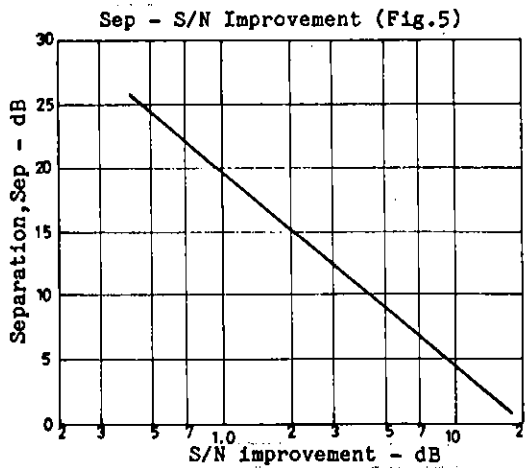
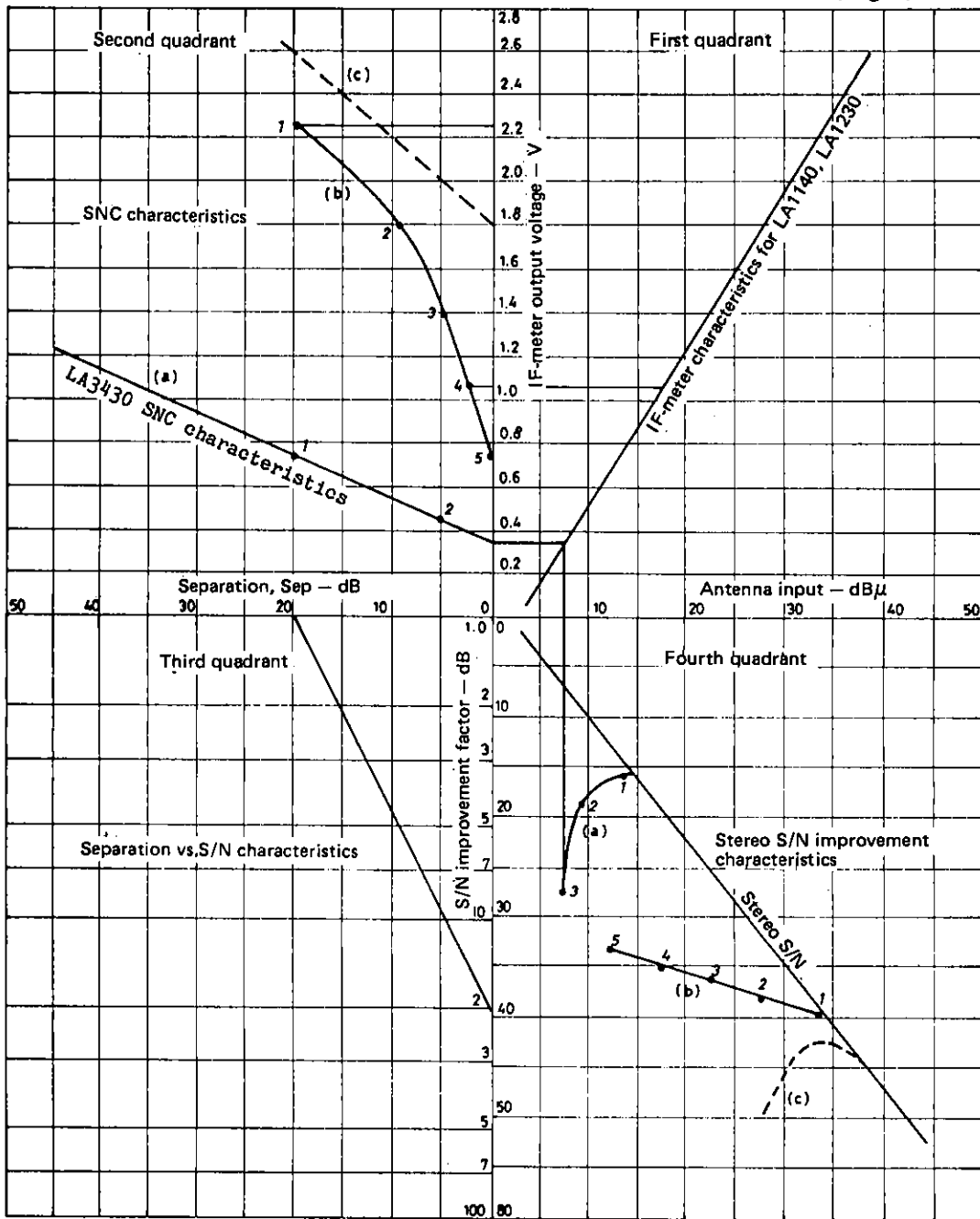
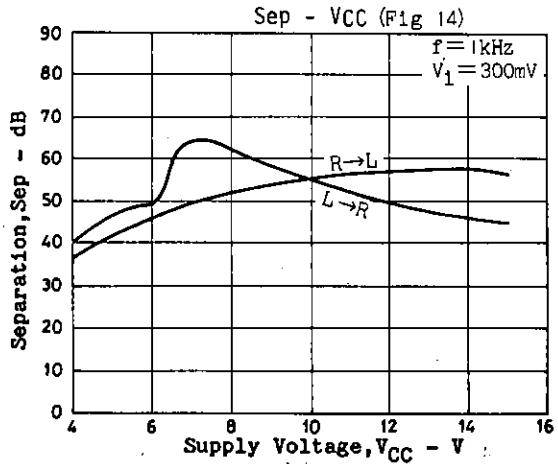
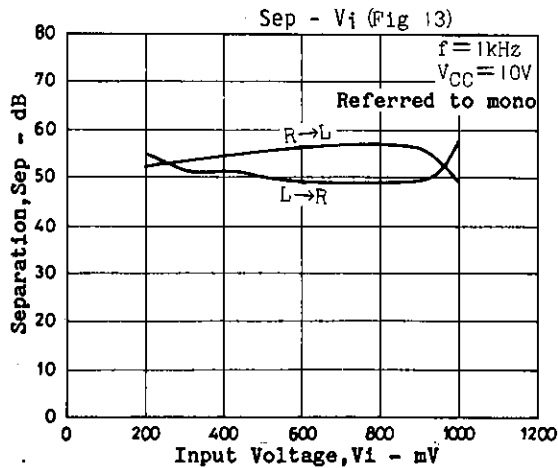
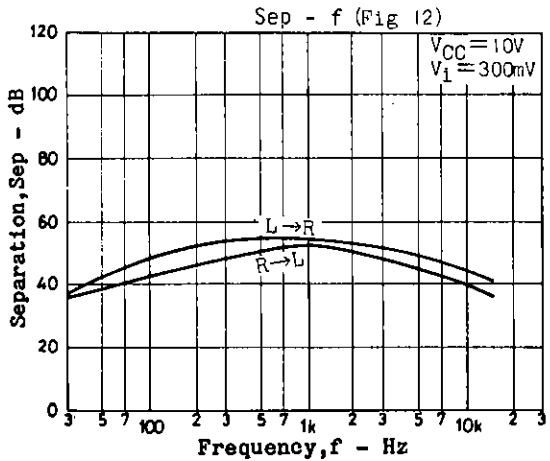
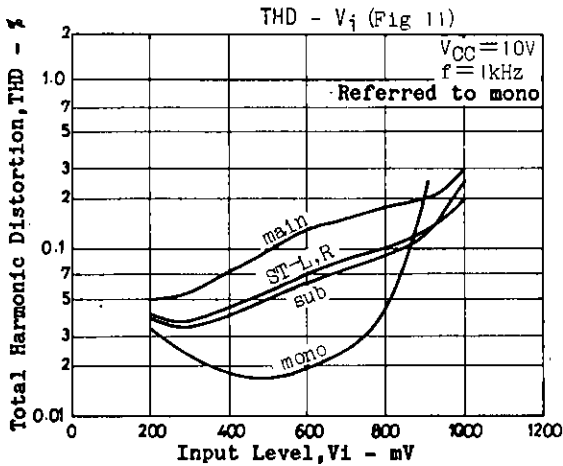
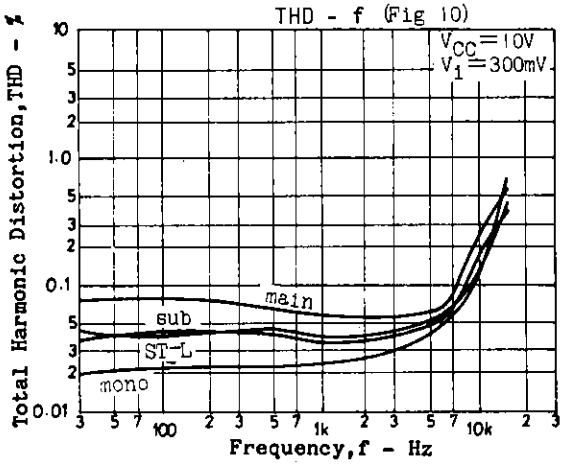
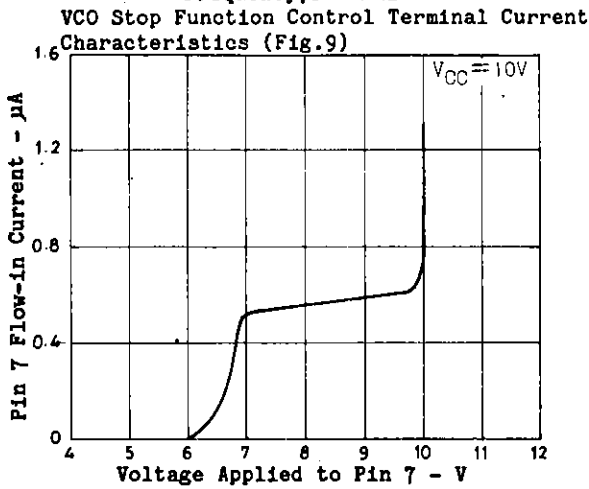
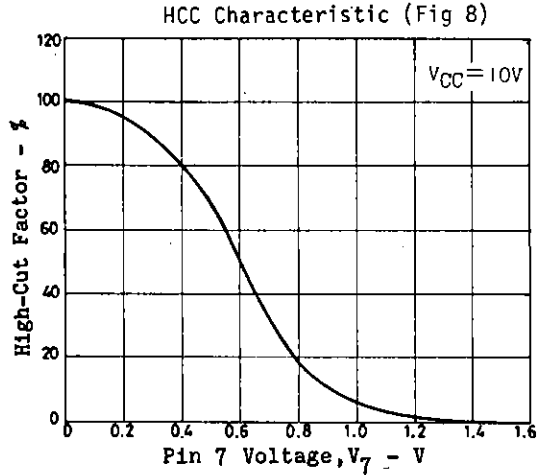
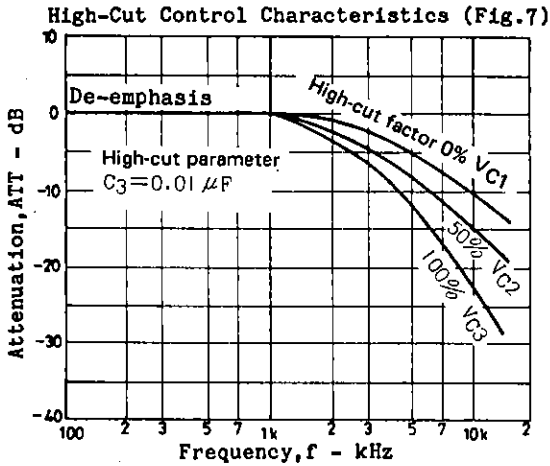
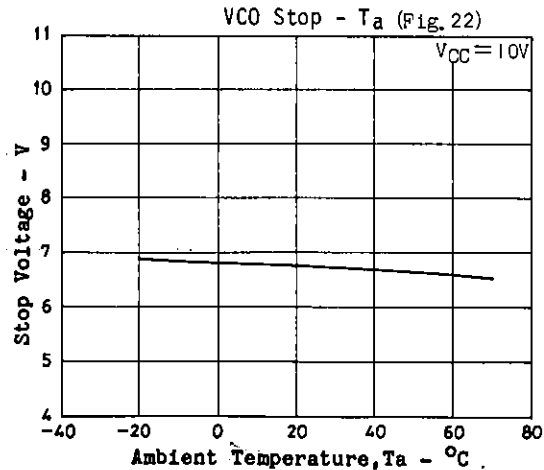
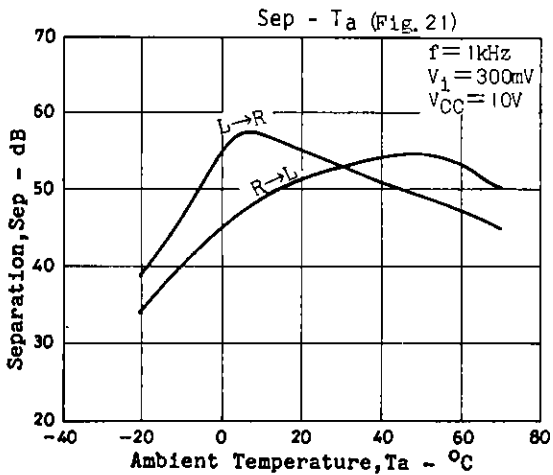
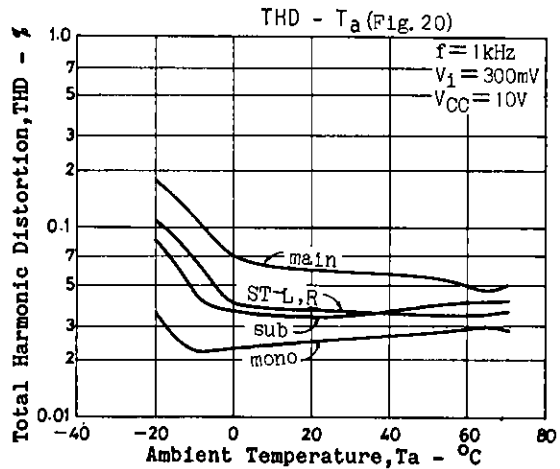
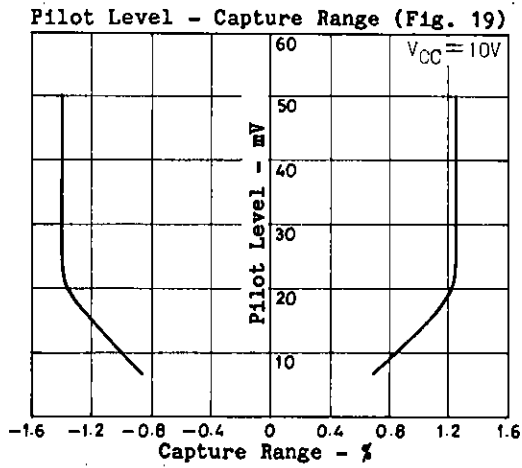
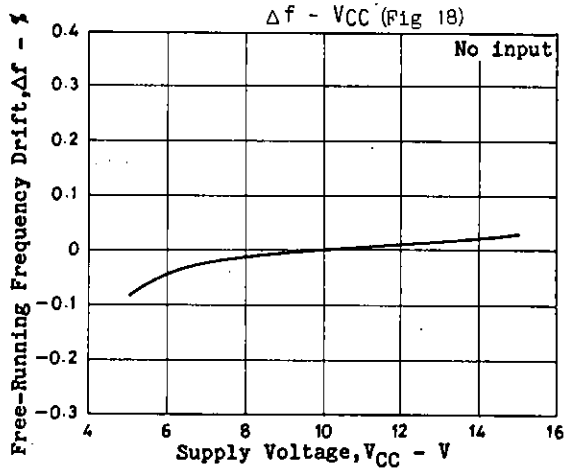
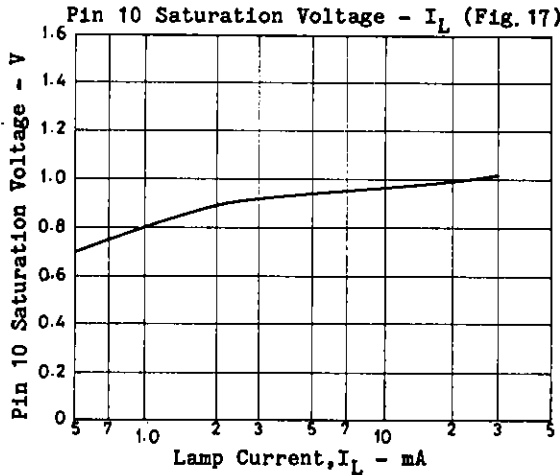
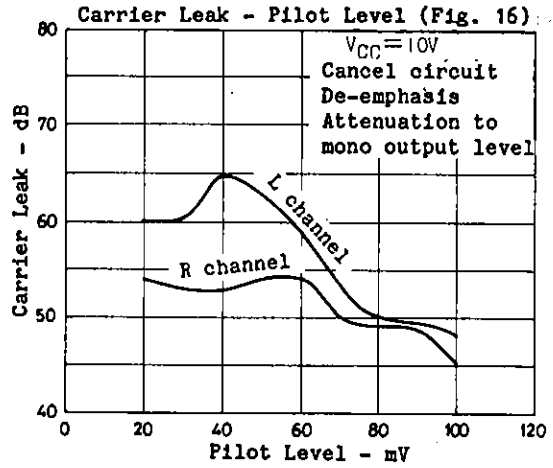
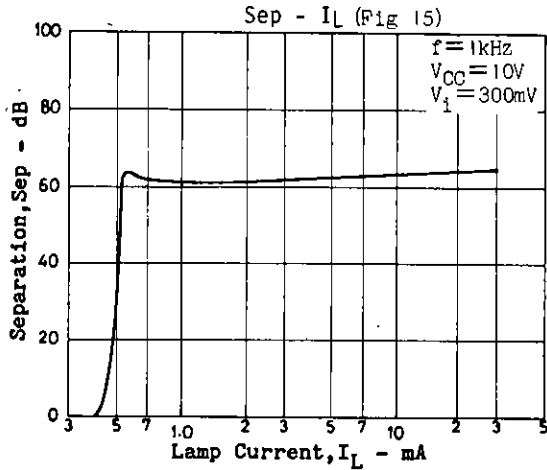
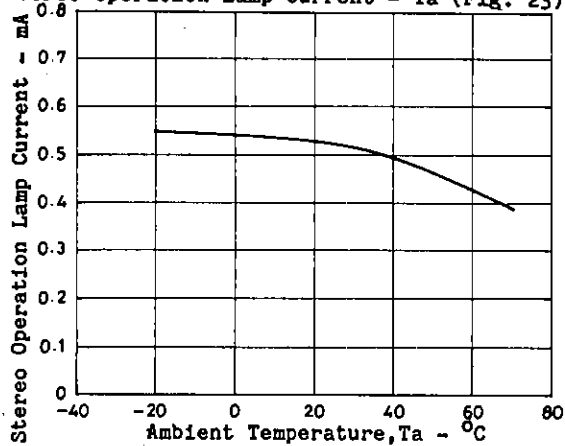
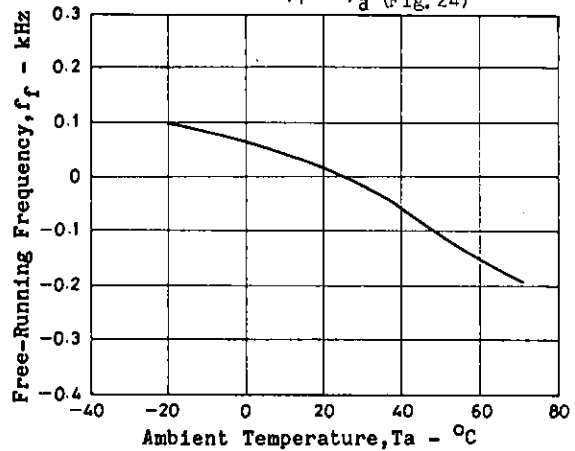
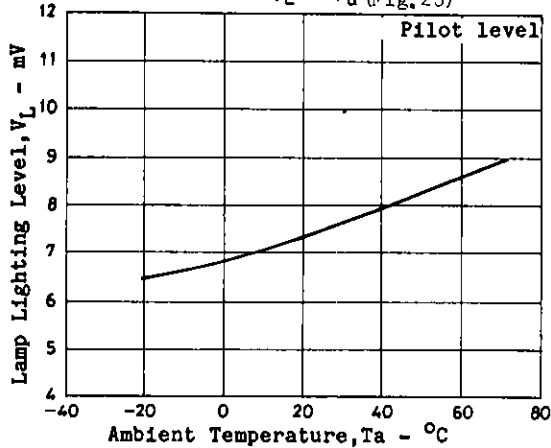

Chart to Obtain Stereo S/N Characteristics from SNC Characteristics (Fig.4)







Stereo Operation Lamp Current - T_a (Fig. 23) $f_f - T_a$ (Fig. 24) $V_L - T_a$ (Fig. 25)

- No products described or contained herein are intended for use in surgical implants, life-support systems, aerospace equipment, nuclear power control systems, vehicles, disaster/crime-prevention equipment and the like, the failure of which may directly or indirectly cause injury, death or property loss.
- Anyone purchasing any products described or contained herein for an above-mentioned use shall:
 - ① Accept full responsibility and indemnify and defend SANYO ELECTRIC CO., LTD., its affiliates, subsidiaries and distributors and all their officers and employees, jointly and severally, against any and all claims and litigation and all damages, cost and expenses associated with such use;
 - ② Not impose any responsibility for any fault or negligence which may be cited in any such claim or litigation on SANYO ELECTRIC CO., LTD., its affiliates, subsidiaries and distributors or any of their officers and employees jointly or severally.
- Information (including circuit diagrams and circuit parameters) herein is for example only; it is not guaranteed for volume production. SANYO believes information herein is accurate and reliable, but no guarantees are made or implied regarding its use or any infringements of intellectual property rights or other rights of third parties.