

POWER FACTOR CORRECTOR

ADVANCE DATA

- VERY PRECISE ADJUSTABLE INTERNAL OUTPUT OVERVOLTAGE PROTECTION
- HYSTERETIC START-UP
($I_{START-UP} < 0.5mA$)
- VERY LOW QUIESCENT CURRENT
($< 3.5mA$)
- INTERNAL START-UP TIMER
- TRANSITION MODE OPERATING
- TOTEM POLE OUTPUT CURRENT: $\pm 400mA$
- DIP8/SO8 PACKAGES

DESCRIPTION

The L6560/A is a monolithic integrated circuit in Minidip and SO8 packages, designed as a controller and driver of a discrete power MOS transistor for the implementation of active power factor correction, for sinusoidal line current consumption.

Realized in mixed BCD technology, the chip integrates:

- An undervoltage lockout with micropower start-up and hysteresis
- An internal temperature compensated precise band gap reference
- A stable error amplifier

MULTIPOWER BCD TECHNOLOGY

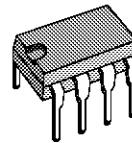

Minidip

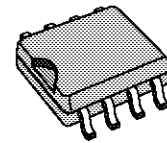

SO8

ORDERING NUMBERS:

L6560	L6560D
L6560A	L6560AD

- One quadrant multiplier
- Current sense comparator
- An output overvoltage protection circuit
- A totem-pole output stage able to drive a POWER MOS or IGBT devices with source and sink current of 400mA. The chip works in transition mode and is particularly intended for lamp ballast applications and for low power SMPS.

BLOCK DIAGRAM

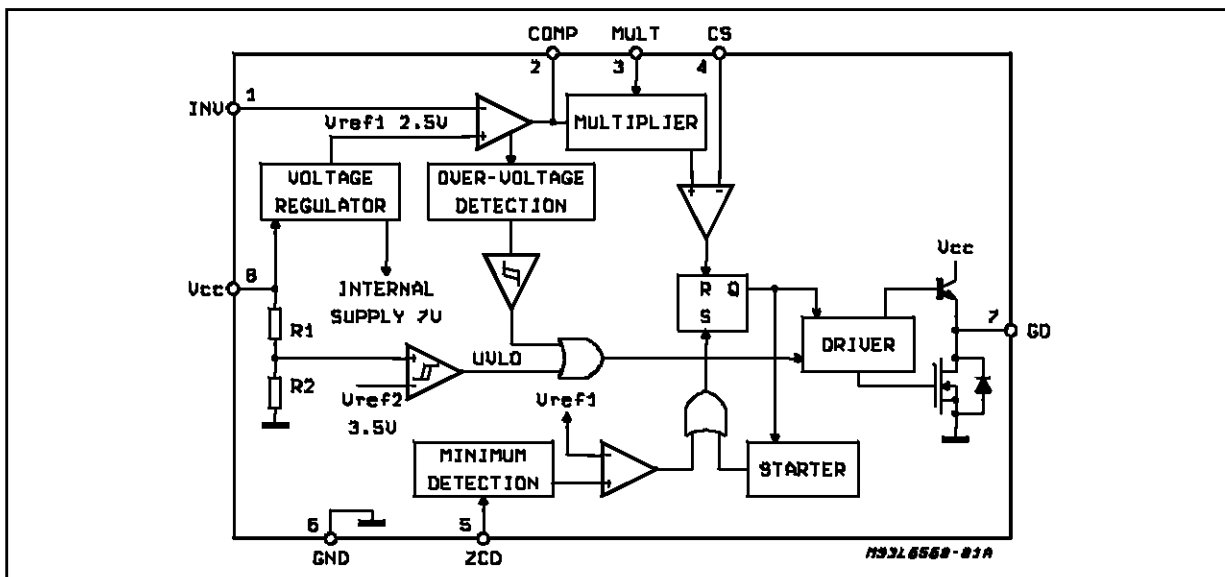

L6560 - L6560A

ABSOLUTE MAXIMUM RATINGS

Symbol	Pin	Parameter	Value	Unit
I _{vcc}	8	I _{cc} + I _z	30	mA
I _{GD}	7	Output Totem Pole Peak Current (2μs)	±700	mA
INV, COMP MULT	1, 2, 3	Analog Inputs & Outputs	-0.3 to 7	V
CS	4	Current Sense Input	-0.3 to 7	V
ZCD	5	Zero Current Detector	5 (source) 10 (sink)	mA mA
P _{tot}		Power Dissipation @T _{amb} = 50 °C (Minidip) (SO8)	1 0.65	W
T _j		Junction Temperature Operating Range	-25 to 150	°C
T _{stg}		Storage Temperature	-55 to 150	°C

PIN CONNECTION

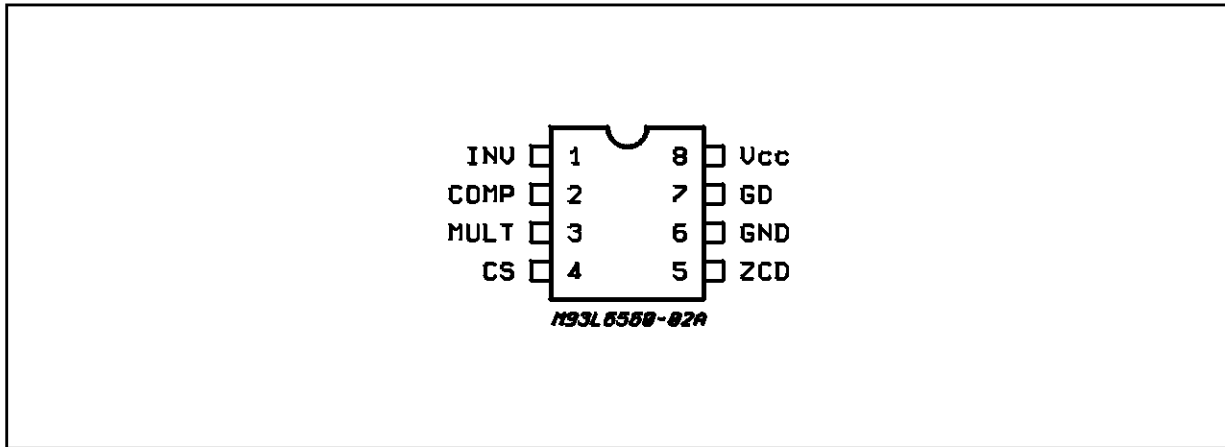

THERMAL DATA

Symbol	Parameter	SO 8	MINIDIP	Unit
R _{th j-amb}	Thermal Resistance Junction-ambient	150	100	°C/W

PIN FUNCTIONS

N.	Name	Function
1	INV	Inverting input of the error amplifier. A resistive divider is connected between output regulated voltage and this point, to provide the voltage feedback.
2	COMP	Output of error amplifier. A feedback compensation network is placed between this pin and the INV pin.
3	MULT	Input of the multiplier stage. A resistive divider connects to this pin the rectified mains. A voltage signal, proportional to the rectified mains, appears on this pin.
4	CS	Input to the comparator of the control loop. The current is sensed by a resistor and the resulting voltage is applied to this pin.
5	ZCD	Zero current detection input.
6	GND	Ground of the control section.
7	GD	Gate driver output. A push pull output stage is able to drive the Power MOS with peak current of 400mA (source and sink).
8	Vcc	Supply voltage of driver and control circuits.

ELECTRICAL CHARACTERISTICS ($V_{CC} = 14.5V$; $T_j = 25^\circ C$ unless otherwise specified)**SUPPLY VOLTAGE SECTION**

Symbol	Pin	Parameter	Test Condition	Min.	Typ.	Max.	Unit
V_{CC}	8	Operating Range	after turn-on	11		18	V
$V_{CC\ ON}$	8	Turn-on Threshold		L6560 L6560A	13.5 14.5	15.5 13	V v
$V_{CC\ OFF}$	8	Turn-off Threshold		L6560 L6560A	9 8.7	10 9.6	V V
Hys	8	Hysteresis		L6560 L6560A	4.3 2.5	4.7 2.8	V V

SUPPLY CURRENT SECTION

Symbol	Pin	Parameter	Test Condition	Min.	Typ.	Max.	Unit
ISTART-U	8	Start-up Current	before turn-on at: $V_{CC} = 13V$ (L6560) $V_{CC} = 10.5V$ (L6560A)		0.3	0.5	mA
I_{CC}	8	Operating Supply Current	$C_L = 0nF @ 70KHz$		2.5	3.5	mA
			$C_L = 1nF @ 70KHz$		3.2	4	mA
			in OVP condition $V_{pin1} = 2.7V$		0.9	1.3	mA
V_Z	8	Zener Voltage	$I_{CC} = 25mA$	18	20	22	V

ERROR AMPLIFIER SECTION

Symbol	Pin	Parameter	Test Condition	Min.	Typ.	Max.	Unit
V_{INV}	1	Voltage Feedback Input Threshold		2.46	2.5	2.54	V
			$-25 \leq T_J \leq 85^\circ C$; $12V < V_{CC} < 18V$	2.43		2.56	
T_S		Temperature Stability	$T_{amb} = -25$ to $85^\circ C$		0.5		%
R_L		Line Regulation	$V_{CC} = 11$ to $18V$		1	4	mV
I_{INV}	1	Input Bias Current			0.1	1	μA
G_V		Voltage Gain	Open loop	60	80		dB
I_{COMP}	2	Source Current ($V_1 < V_{ref}$)	$V_{COMP} = 5V$	0.14	0.2		mA
		Sink Current ($V_1 > V_{ref}$)		0.5	1		mA

MULTIPLIER SECTION

Symbol	Pin	Parameter	Test Condition	Min.	Typ.	Max.	Unit
V_{MULT}	3	Operating Voltage		0 to 2.5	0 to 4.2		V
$\frac{\Delta V_{CS}}{\Delta V_{mult}}$		Output Max. Slope	$V_{MULT} =$ from $0V$ to $1V$ $V_{COMP} = 6V$	0.9	1.25	1.6	
K		Gain	$V_{MULT} = 1V$ $V_{COMP} = 5V$	0.45	0.65	0.85	1/V

CURRENT SENSE COMPARATOR

Symbol	Pin	Parameter	Test Condition	Min.	Typ.	Max.	Unit
V_{CS}	4	Voltage Threshold	$V_{MULT} = 2.5V$ $V_{COMP} = 6V$	1.6		1.9	V
I_{CS}	4	Input Bias Current				5	μA
t_d (H-L)	4	Delay to Output			200	400	ns

ELECTRICAL CHARACTERISTICS (continued)
ZERO CURRENT DETECTOR

Symbol	Pin	Parameter	Test Condition	Min.	Typ.	Max.	Unit
V _{ZCD}	5	Input Threshold Voltage Rising Edge		1.8		2.3	V
		Hysteresis		0.3	0.5	0.7	V
V _{ZCD}	5	Clamp Voltage	I _{ZCD} = 3mA	5	5.7	6.4	V
V _{ZCD}	5	Clamp Voltage	I _{ZCD} = -3mA	0.4	0.7	1	V

OUTPUT SECTION

Symbol	Pin	Parameter	Test Condition	Min.	Typ.	Max.	Unit
V _{GD}	7	Dropout Voltage	I _{GDsource} = 200mA		1.2	2	V
			I _{GDsource} = 20mA		0.7	1	V
			I _{GDsink} = 200mA			1.5	V
			I _{GDsink} = 20mA			0.3	V
t _r	7	Output Voltage Rise Time	CL = 1nF		50	120	ns
t _f	7	Output Voltage Fall Time	CL = 1nF		40	100	ns

OUTPUT OVERVOLTAGE SECTION

Symbol	Pin	Parameter	Test Condition	Min.	Typ.	Max.	Unit
I _{OVP}	2	OVP Triggering Current		36	40	44	μA

RESTART TIMER

Symbol	Pin	Parameter	Test Condition	Min.	Typ.	Max.	Unit
t _{START}		Start Timer		45	60		μs

OVER VOLTAGE PROTECTION OVP

The output voltage is expected to be kept by the operation of the PFC circuits close to its reference value that is set by the ratio of the two external resistors R₁ and R₂ (see fig. 2), taking into consideration that the non inverting input of the error amplifier is biased inside the L6560 at 2.5V.

In steady state conditions, the current through R₁ and R₂ is:

$$I_{SC} = \frac{\Delta V_{outsc} \cdot 2.5}{R_1}$$

$$\text{or } I_{SC} = \frac{2.5}{R_2}$$

and, if the external compensation network is made only with a capacitor C, the current through C is equal zero.

When the output voltage increases abruptly the current through R₁ becomes:

$$I_{R1} = \frac{V_{out} - 2.5}{R_1}$$

$$I_{R1} = \frac{V_{outsc} + \Delta V_{OUT} - 2.5}{R_1} = I_{sc} + \Delta I.$$

Since the current through R₂ doesn't change, the ΔI current must flow through the capacitor C and enter in the error amplifier.

This current is mirrored inside the L6560, and compared with a precise internal reference of 40μA. Whenever such 40μA limit is exceeded, the OVP protection is triggered (Dynamic OVP), and the external power transistor is switched off, until the overvoltage situation disappears. However if the overvoltage persists, before that the transient condition of dynamic circuit exhausts, an internal comparator (Static OVP) latches the OVP condition keeping the external power switch turned off (see fig. 1).

The OVP value is therefore set by the equation OVP = ΔV_{out} = R₁ · 40μA.

Typical values for R₁, R₂ and C are reported in the application circuit. The overvoltage can be set independently from the average output voltage. The precision in setting the overvoltage threshold is 7% of the overvoltage value (for instance ΔV = 60V ± 4.2V).

Figure 1.

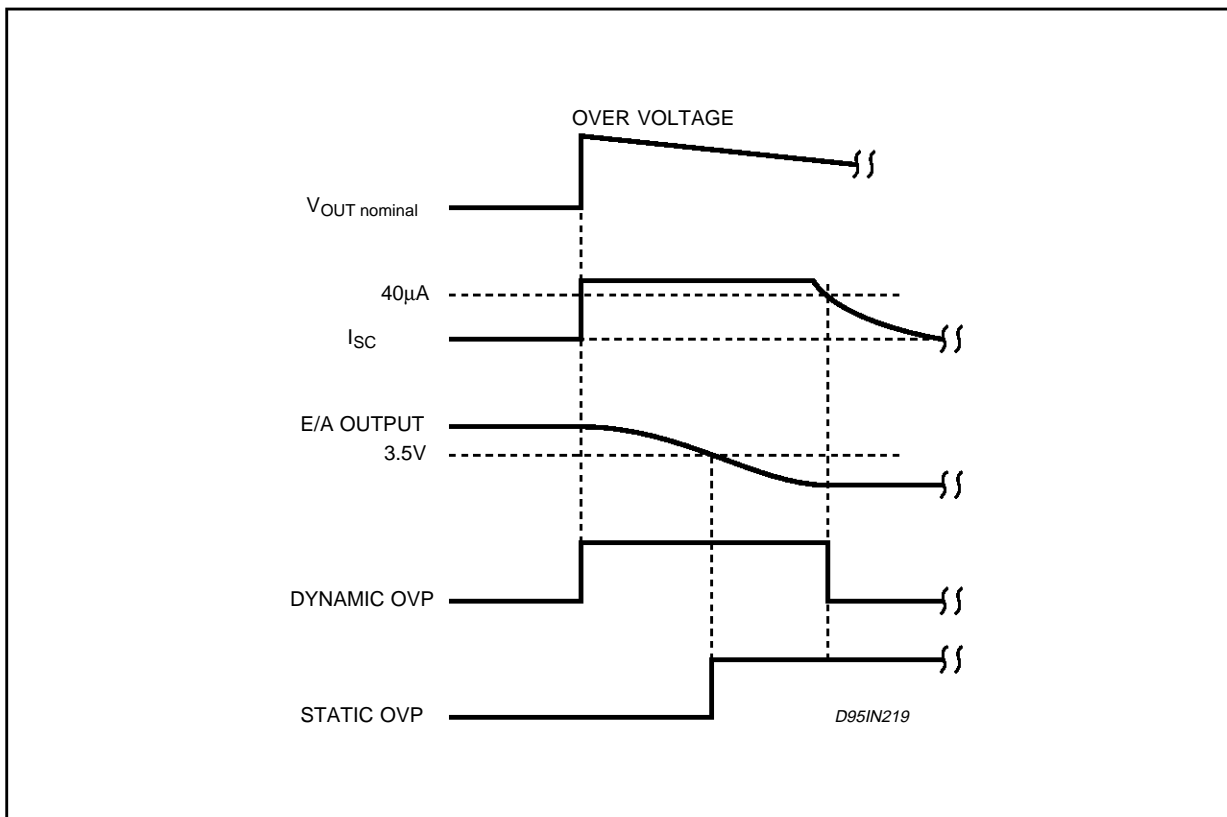
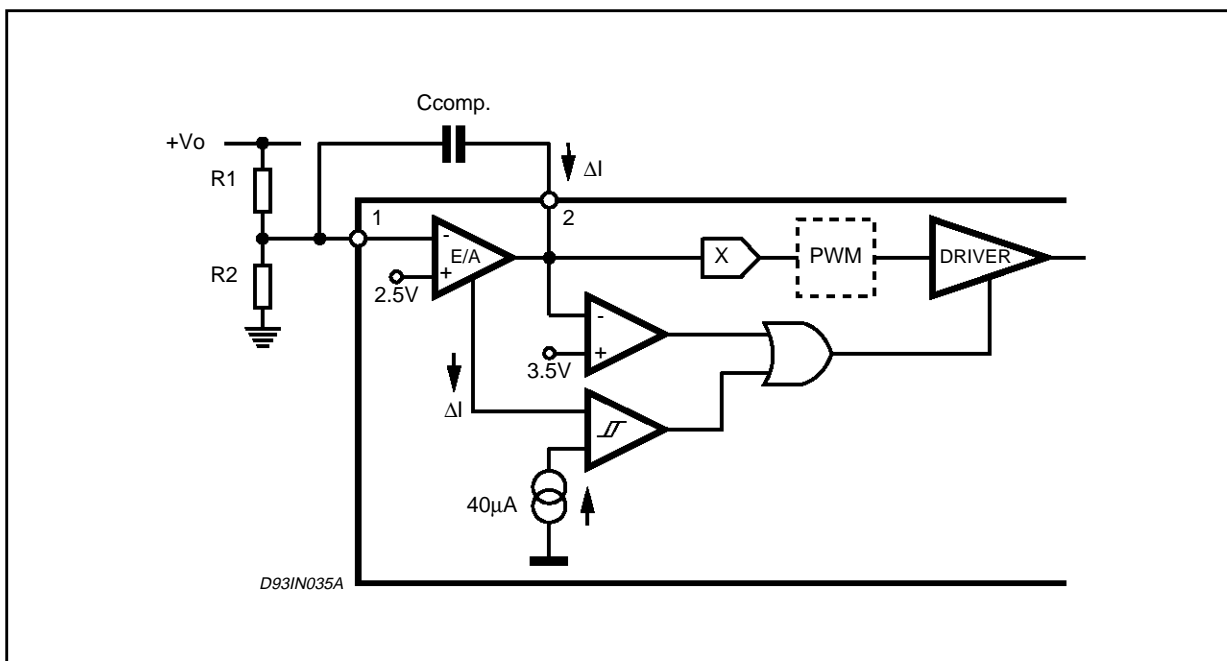

Figure 2: Overvoltage Protection Circuit



L6560 - L6560A

Figure 3: Typical Application Circuit (100W)

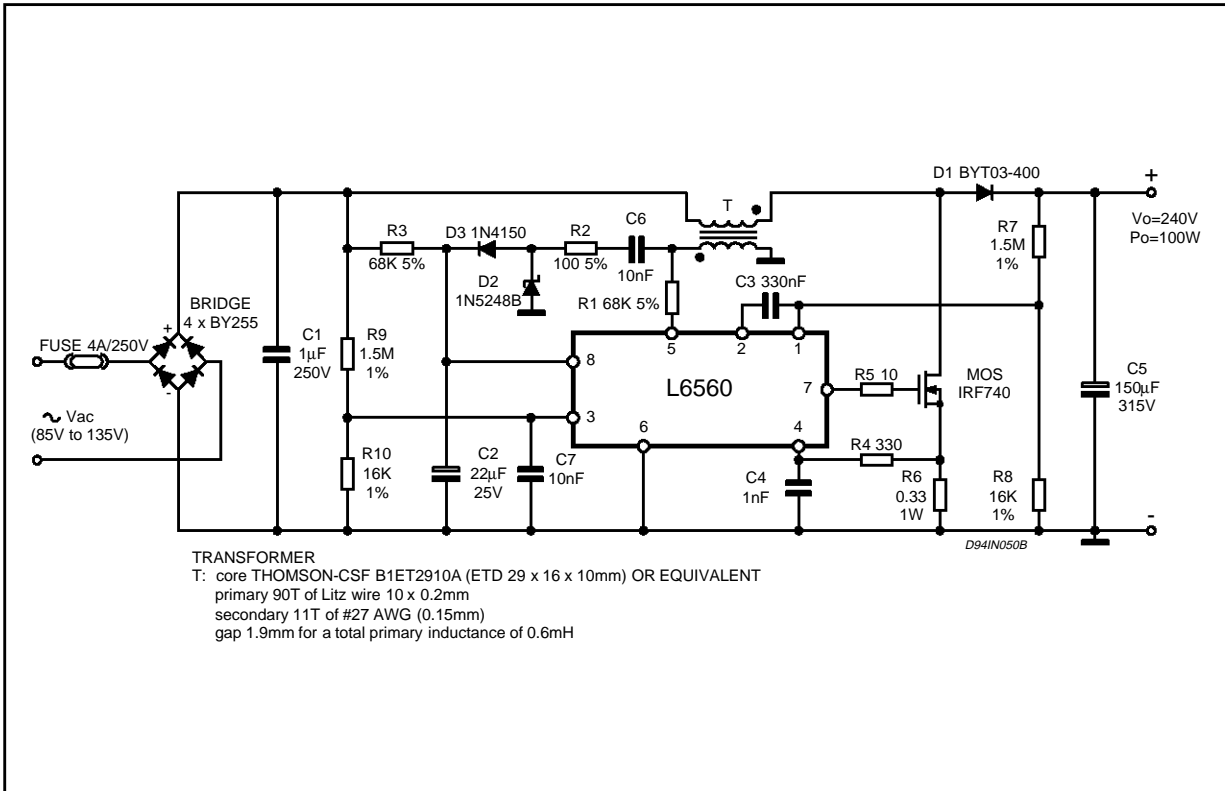

Figure 4: Typical Application Circuit (120W)

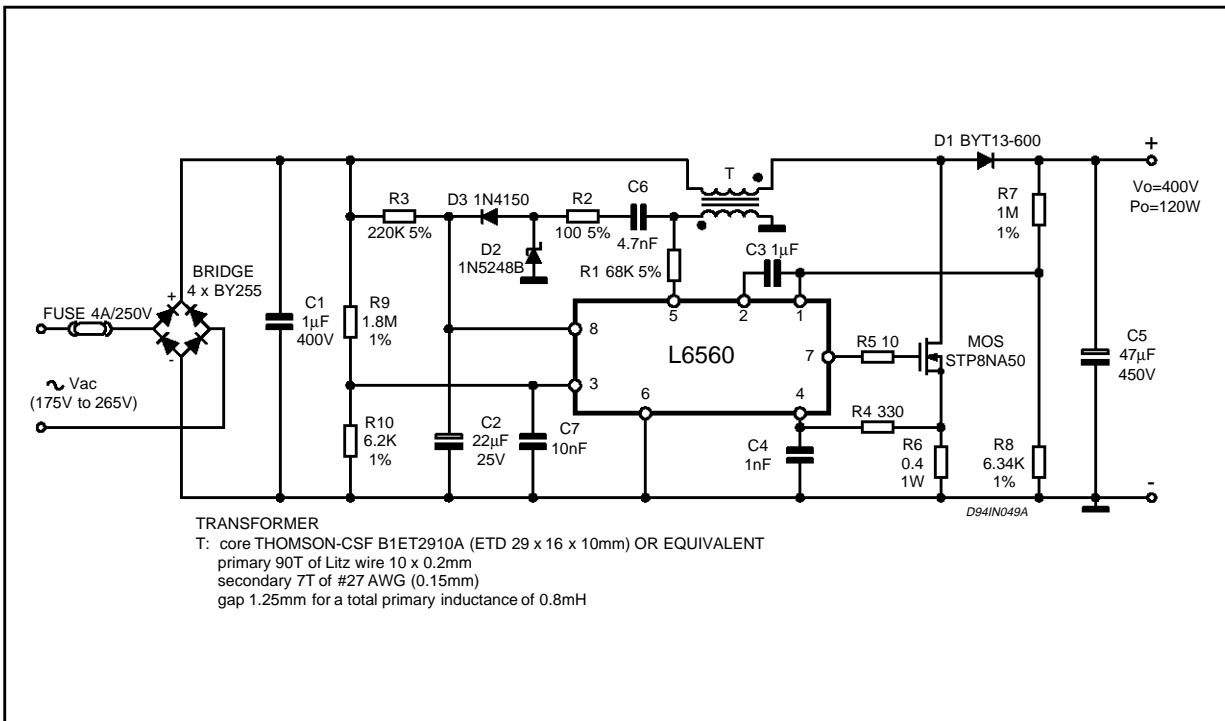

Figure 5: P.C. Board and Component Layout of the Figg. 3 and 4 (1:1.25 scale)

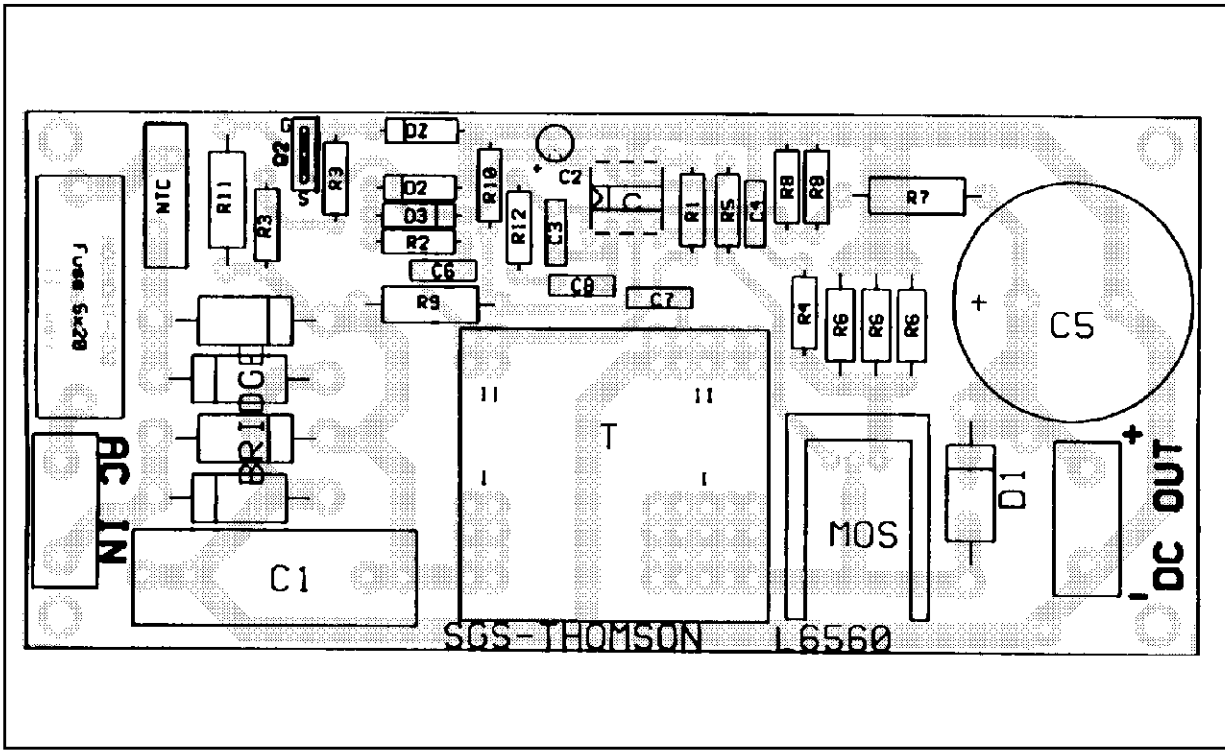

Figure 6: OVP Current Threshold vs. Temperature

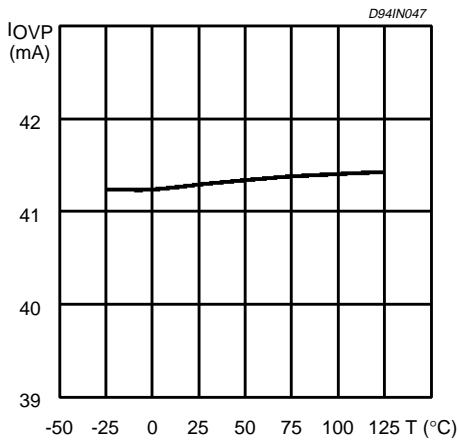

Figure 7: Undervoltage Lockout Threshold vs. Temperature

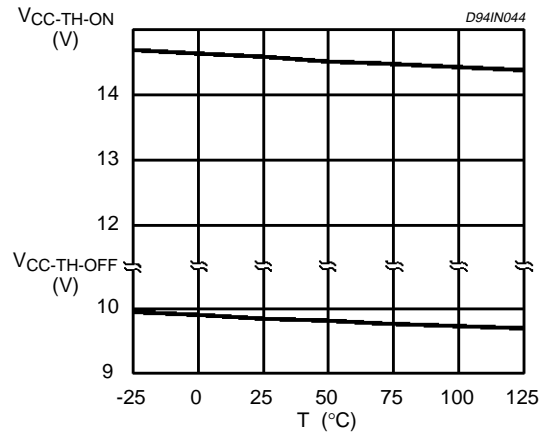

Figure 8: Supply Current vs. Supply Voltage

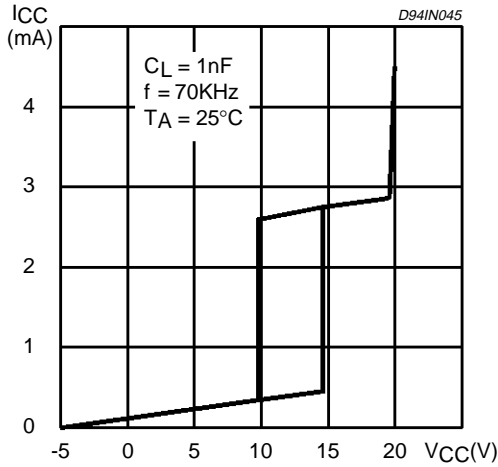

Figure 9: Voltage Feedback Input Threshold vs. Temperature

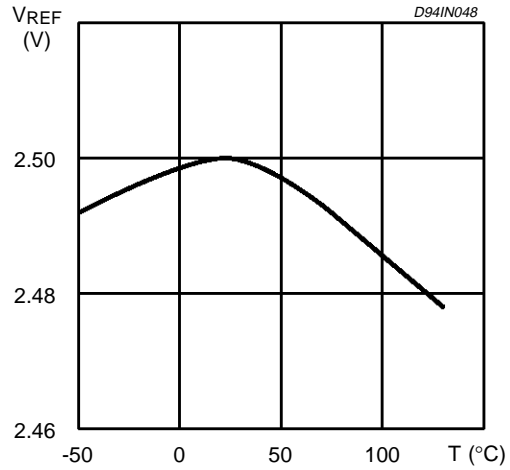

Figure 10: Output Saturation Voltage vs. Sink Current

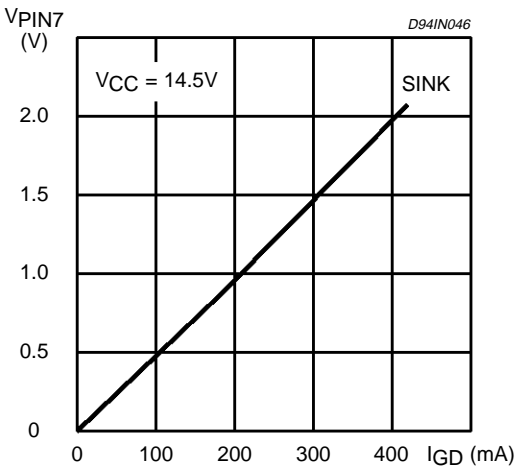

Figure 11: Output Saturation Voltage vs. Source Current

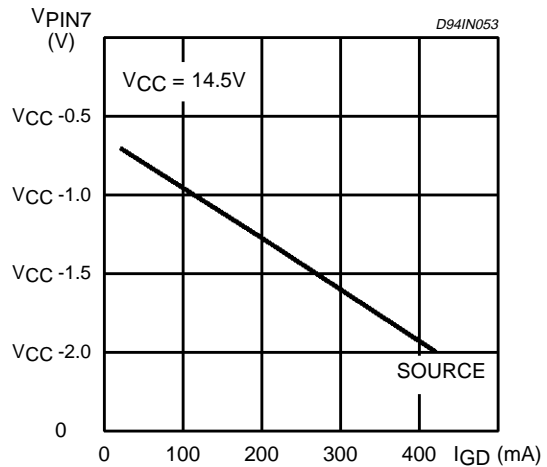

Figure 12: Multiplier Characteristics Family

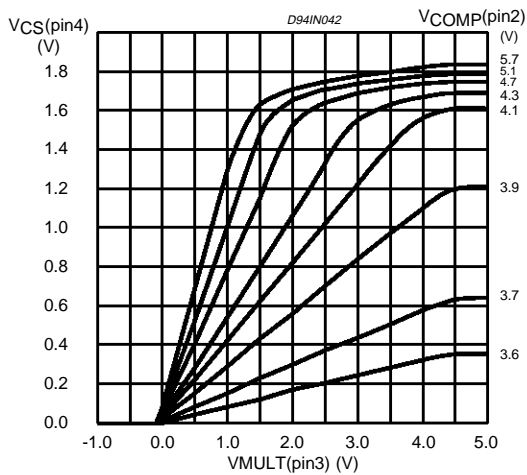
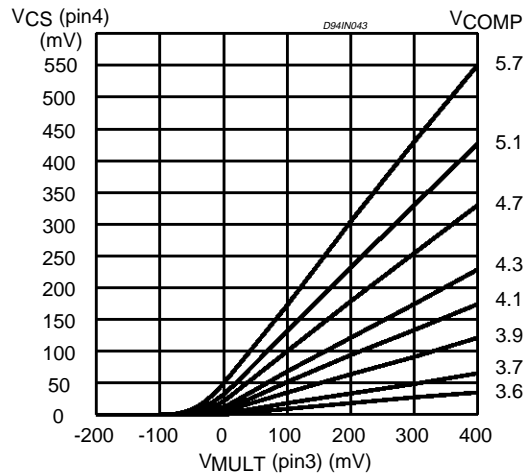
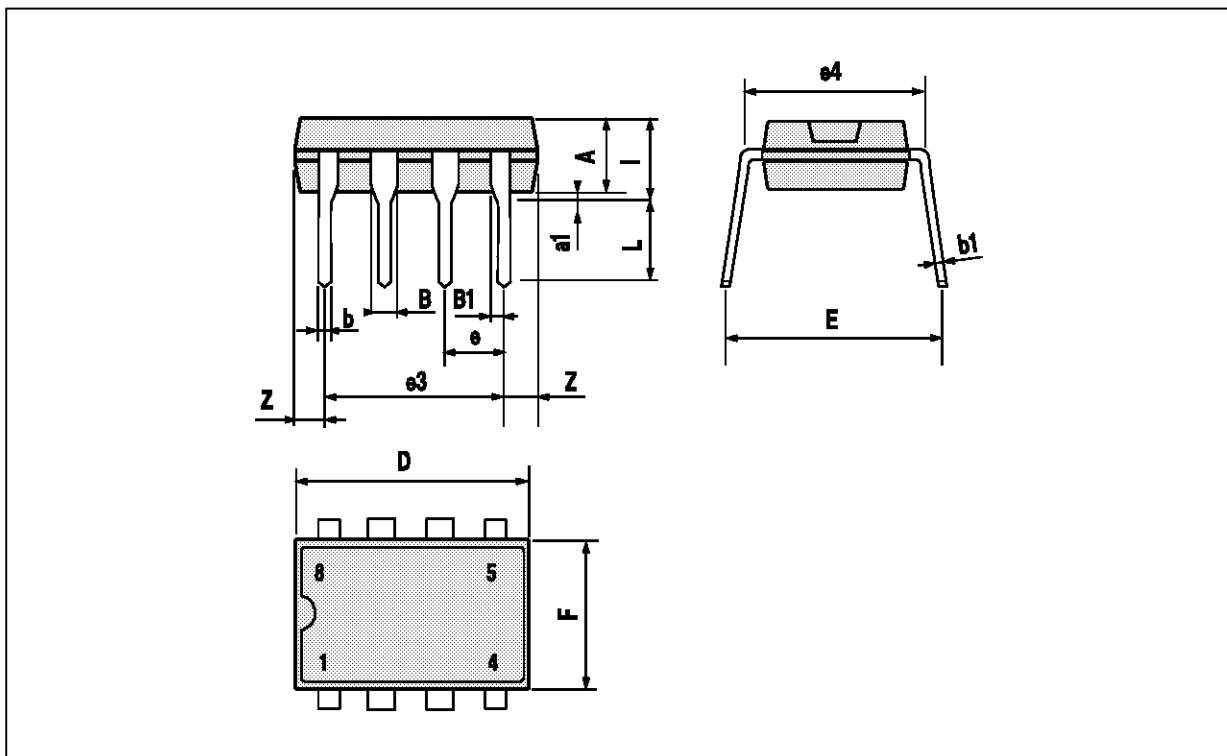

Figure 13: Multiplier Characteristics Family



MINIDIP PACKAGE MECHANICAL DATA

DIM	mm			inch		
	Min.	Typ.	Max.	Min.	Typ.	Max.
A		3.32			0.131	
a1	0.51			0.020		
B	1.15		1.65	0.045		0.065
b	0.356		0.55	0.014		0.022
b1	0.204		0.304	0.008		0.012
D			10.92			0.430
E	7.95		9.75	0.313		0.384
e		2.54			0.100	
e3		7.62			0.300	
e4		7.62			0.300	
F			6.6			0.260
i			5.08			0.200
L	3.18		3.81	0.125		0.150
Z			1.52			0.060



SO8 PACKAGE MECHANICAL DATA

DIM	mm			inch		
	Min.	Typ.	Max.	Min.	Typ.	Max.
A			1.75			0.069
a1	0.1		0.25	0.004		0.010
a2			1.65			0.065
a3	0.65		0.85	0.026		0.033
b	0.35		0.48	0.014		0.019
b1	0.19		0.25	0.007		0.010
C	0.25		0.5	0.010		0.020
c1	45° (typ.)					
D	4.8		5.0	0.189		0.197
E	5.8		6.2	0.228		0.244
e		1.27			0.050	
e3		3.81			0.150	
F	3.8		4.0	0.150		0.157
L	0.4		1.27	0.016		0.050
M			0.6			0.024
S	8° (max.)					

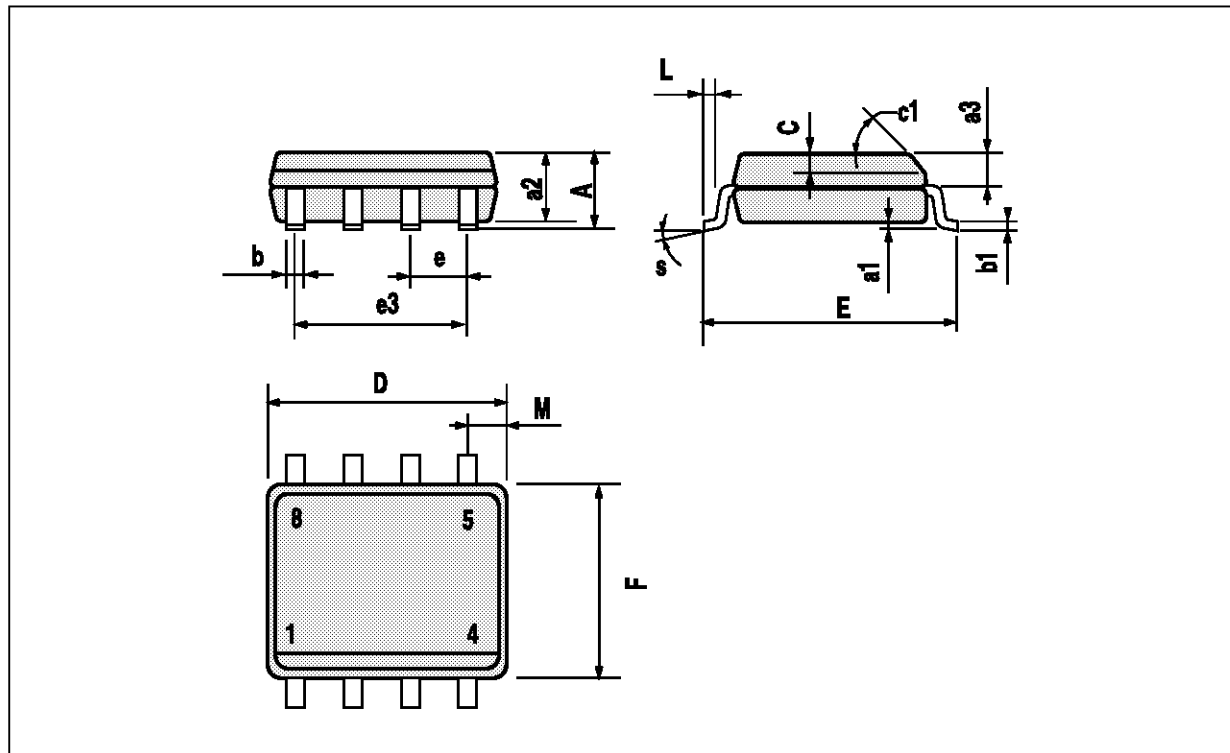

Information furnished is believed to be accurate and reliable. However, SGS-THOMSON Microelectronics assumes no responsibility for the consequences of use of such information nor for any infringement of patents or other rights of third parties which may result from its use. No license is granted by implication or otherwise under any patent or patent rights of SGS-THOMSON Microelectronics. Specifications mentioned in this publication are subject to change without notice. This publication supersedes and replaces all information previously supplied. SGS-THOMSON Microelectronics products are not authorized for use as critical components in life support devices or systems without express written approval of SGS-THOMSON Microelectronics.

© 1994 SGS-THOMSON Microelectronics - All Rights Reserved

SGS-THOMSON Microelectronics GROUP OF COMPANIES
Australia - Brazil - France - Germany - Hong Kong - Italy - Japan - Korea - Malaysia - Malta - Morocco - The Netherlands
Singapore - Spain - Sweden - Switzerland - Taiwan - Thailand - United Kingdom - U.S.A.