

## VERY LOW DROP ADJUSTABLE REGULATORS

- VERY LOW DROP VOLTAGE
- ADJUSTABLE OUTPUT VOLTAGE FROM 1.25V TO 20V
- 400mA OUTPUT CURRENT
- LOW QUIESCENT CURRENT
- REVERSE VOLTAGE PROTECTION
- + 60/ - 60V TRANSIENT PEAK VOLTAGE PROTECTION
- SHORT CIRCUIT PROTECTION WITH FOLDBACK CHARACTERISTICS
- THERMAL SHUT-DOWN

### DESCRIPTION

The L4920 and L4921 are adjustable voltage regulators with a very low voltage drop (0.4V typ. at 0.4A  $T_j = 25^\circ\text{C}$ ), low quiescent current and comprehensive on-chip protection.

These devices are protected against load dump and field decay transients, polarity reversal and over heating.

A foldback current limiter protects against load short circuits.

The output voltage is adjustable through an external divider from 1.25V to 20V. The minimum operating input voltage is 5.2V ( $T_j = 25^\circ\text{C}$ ).

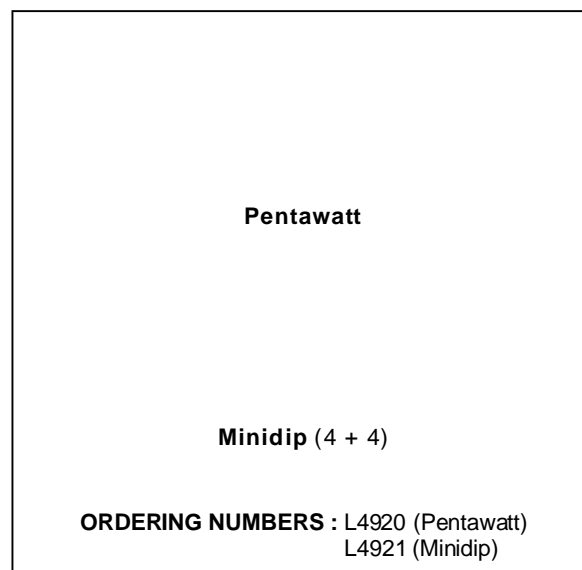

These regulators are designed for automotive, industrial and consumer applications where low consumption is particularly important.

In battery backup and standby applications the low consumption of these devices extends battery life.

### BLOCK DIAGRAM

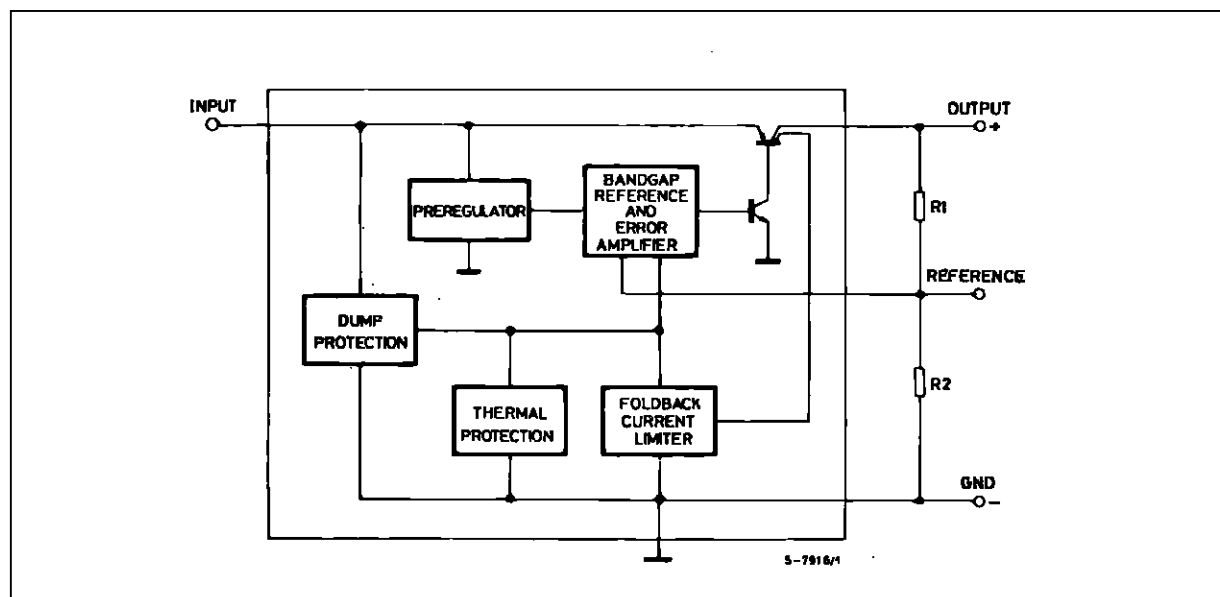

**ABSOLUTE MAXIMUM RATINGS**

Symbol	Parameter	Value	Unit
$V_i$	DC Input Operating Voltage DC Reverse Input Voltage Transient Input Overvoltages: Load Dump: $5ms \leq t_{rise} \leq 10ms$ $\tau_f$ Fall time constant = 100ms $R_{SOURCE} \geq 0.5\Omega$ Field Decay: $5ms \leq t_{fall} \leq 10ms$ , $R_{SOURCE} \geq 10\Omega$ $\tau_f$ Rise time constant = 33ms	35	V
$T_J, T_{STG}$	Junction and Storage Temperature Range	- 55 to 150	°C

**PIN CONNECTIONS (top view)**

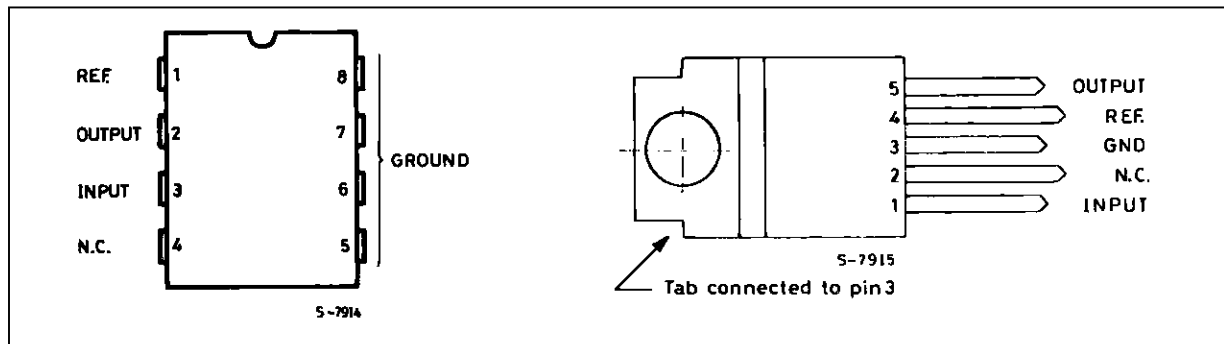

**TEST AND APPLICATION CIRCUIT**

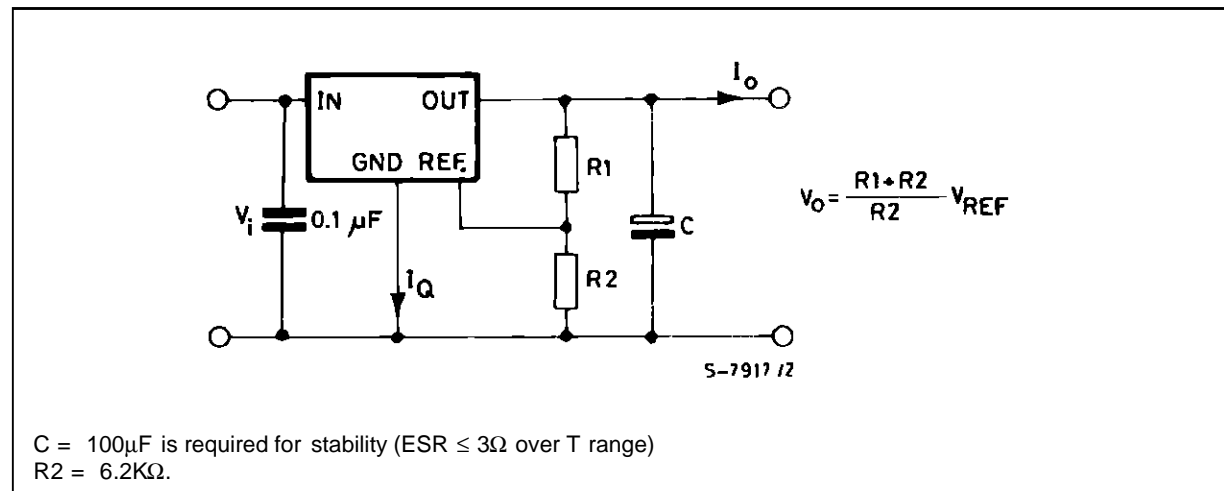

**THERMAL DATA**

Symbol	Parameter		Minidip (4 + 4)	Pentawatt
$R_{th j-amb}$	Thermal Resistance Junction-ambient	Max	80 °C/W	60 °C/W
$R_{th j-pins}$	Thermal Resistance Junction-pins	Max	15 °C/W	-
$R_{th j-case}$	Thermal Resistance Junction-case	Max	-	3.5 °C/W

**ELECTRICAL CHARACTERISTICS** (for  $V_I = 14.4V$ ,  $T_J = 25^\circ C$ ,  $V_O = 5V$ ,  $C_O = 100\mu F$ , unless Otherwise Specified)

Symbol	Parameter	Test Condition	Min.	Typ.	Max.	Unit
$V_I$	Operating Input Voltage	$V_O \geq 4.5V$ , $I_O = 400mA$	$V_O + 0.7$		26	V
		$V_{REF} \leq V_O < 4.5V$ , $I_O = 400mA$	5.2		26	V
$V_{REF}$	Reference Voltage	$5.2V < V_I < 26V$ $5mA \leq I_O \leq 400mA$ (*)	1.20	1.25	1.30	V
$\Delta V_O$	Line Regulation	$V_O + 1V < V_I < 26V$ , $V_O \geq 4.5V$ $I_O = 5mA$		1	10	mV/V
$\Delta V_O$	Load Regulation	$5mA \leq I_O \leq 400mA$ (*) $V_O \geq 4.5V$		3	15	mV/V
$V_D$	Dropout Voltage	$I_O = 10mA$		0.05		V
		$I_O = 150mA$		0.2	0.4	V
		$I_O = 400mA$		0.4	0.7	V
$I_Q$	Quiescent Current	$I_O = 0mA$ $V_O + 1V < V_I < 26V$		0.8	2	mA
		$I_O = 400mA$ (*) $V_O + 1V < V_I < 26V$		65	90	mA
$I_O$	Maximal Output Current			800		mA
$I_{osc}$	Short Circuit Output Current (*)			350	500	mA

(\*) Foldback protection

**ELECTRICAL CHARACTERISTICS** (for  $V_I = 14.4V$ ,  $-40 \leq T_J \leq 125^\circ C$  (note 1),  $V_O = 5V$ ,  $C_O = 100\mu F$ , unless Otherwise Specified)

Symbol	Parameter	Test Condition	Min.	Typ.	Max.	Unit
$V_I$	Operating Input Voltage	$V_O \geq 4.5V$ , $I_O = 400mA$	$V_O + 0.9$		26	V
		$V_{REF} \leq V_O < 4.5V$ , $I_O = 400mA$	5.2		26	V
$V_{REF}$	Reference Voltage	$5.4V < V_I < 26V$	1.17	1.25	1.33	V
$\Delta V_O$	Line Regulation	$V_O + 1.2V < V_I < 26V$ , $V_O \geq 4.5V$ $I_O = 5mA$		2	15	mV/V
$\Delta V_O$	Load Regulation	$5mA \leq I_O \leq 400mA$ (*) $V_O \geq 4.5V$		5	25	mV/V
$V_D$	Dropout Voltage	$I_O = 150mA$		0.2	0.4	V
		$I_O = 400mA$		0.4	0.7	V
$I_Q$	Quiescent Current	$I_O = 0mA$ $V_O + 1.2V < V_I < 26V$		1,2	3	mA
		$I_O = 400mA$ (*) $V_O + 1.2V < V_I < 26V$		80	140	mA
$I_O$	Maximal Output Current			870		mA
$I_{osc}$	Short Circuit Output Current (*)			230	500	mA

(\*) Foldback protection.

**Note :** 1. Design limits are guaranteed (but not 100% production tested) over the indicated temperature and supply voltage ranges. These limits are not used to calculate outgoing quality levels.

Figure 1 : Output Voltage vs. Temperature.

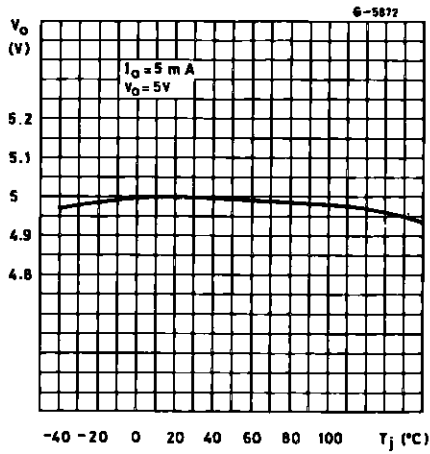

Figure 2 : Foldback Current Limiting.

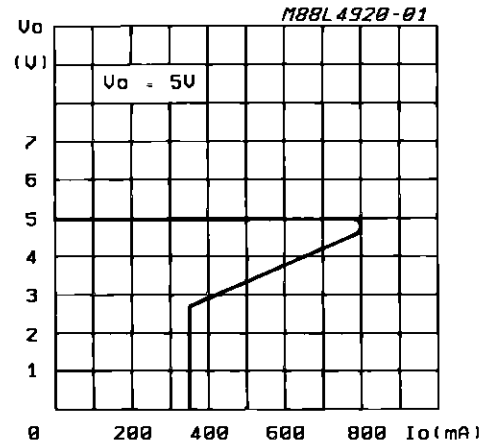
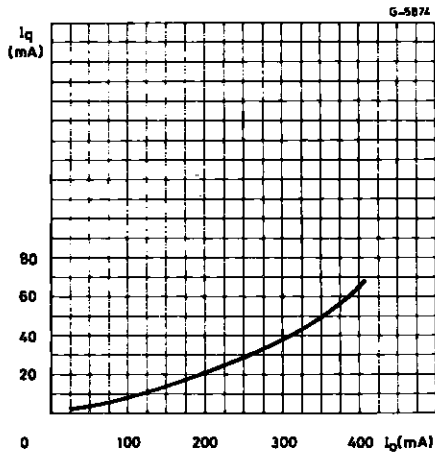

Figure 3 : Quiescent Current vs. Output Current ( $V_o = 5 \text{ V}$ ).



**APPLICATION INFORMATION**

- 1) The L4920 and L4921 have  $V_{REF} \cong 1.25 \text{ V}$ . Then the output voltage can be set down to  $V_{REF}$  but  $V_i$  must be greater than 5.2V ( $T_j = 25^\circ \text{ C}$ ).
- 2) As the regulator reference voltage source works in closed loop, the reference voltage may change in foldback condition.
- 3) For applications with high  $V_i$ , the total power dissipation of the device with respect to the ther-

mal resistance of the package may be limiting . The total power dissipation is :

$$P_{tot} = V_i I_q + (V_i - V_o) I_o$$

A typical curve giving the quiescent current  $I_q$  as a function of the output current  $I_o$  is shown in fig. 3.

## MINIDIP 4+4 PACKAGE MECHANICAL DATA

DIM.	mm			inch		
	MIN.	TYP.	MAX.	MIN.	TYP.	MAX.
A		3.3			0.130	
a1	0.7			0.028		
B	1.39		1.65	0.055		0.065
B1	0.91		1.04	0.036		0.041
b		0.5			0.020	
b1	0.38		0.5	0.015		0.020
D			9.8			0.386
E		8.8			0.346	
e		2.54			0.100	
e3		7.62			0.300	
e4		7.62			0.300	
F			7.1			0.280
I			4.8			0.189
L		3.3			0.130	
Z	0.44		1.6	0.017		0.063

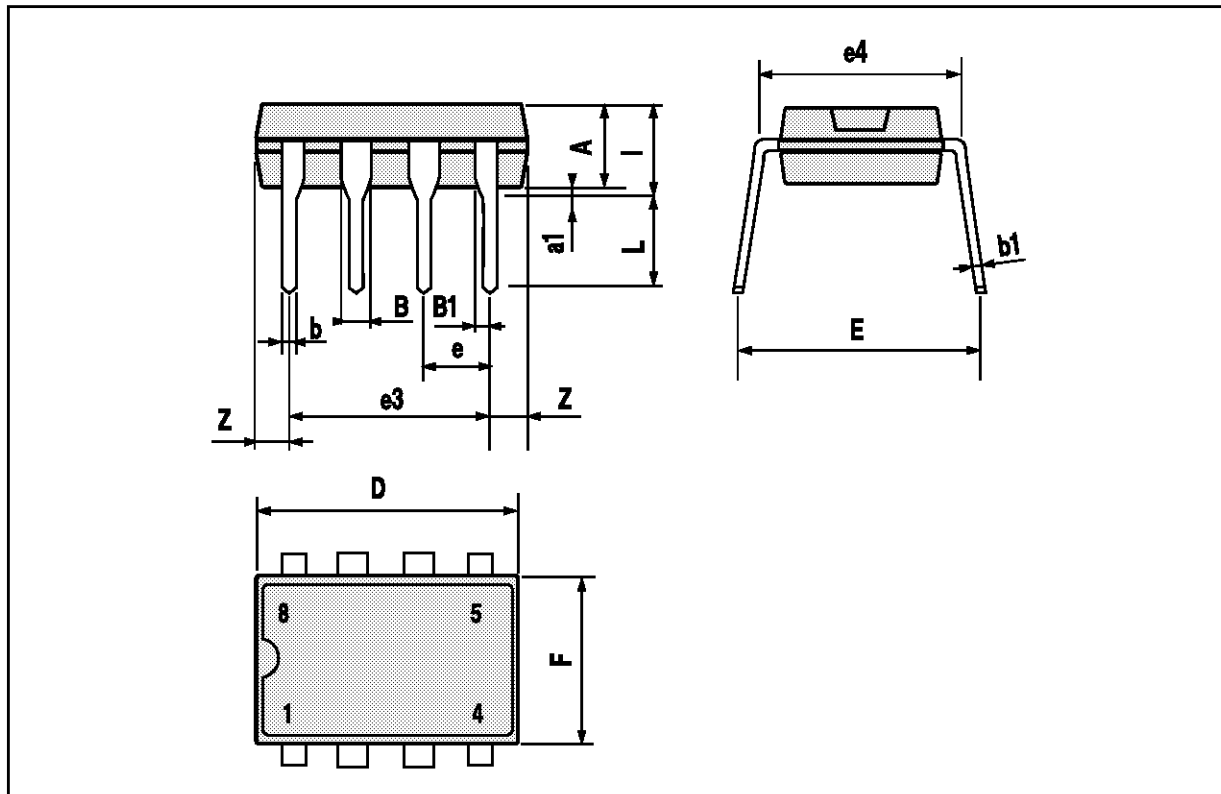

## PENTAWATT PACKAGE MECHANICAL DATA

DIM.	mm			inch		
	MIN.	TYP.	MAX.	MIN.	TYP.	MAX.
A			4.8			0.189
C			1.37			0.054
D	2.4		2.8	0.094		0.110
D1	1.2		1.35	0.047		0.053
E	0.35		0.55	0.014		0.022
F	0.8		1.05	0.031		0.041
F1	1		1.4	0.039		0.055
G		3.4		0.126	0.134	0.142
G1		6.8		0.260	0.268	0.276
H2			10.4			0.409
H3	10.05		10.4	0.396		0.409
L		17.85			0.703	
L1		15.75			0.620	
L2		21.4			0.843	
L3		22.5			0.886	
L5	2.6		3	0.102		0.118
L6	15.1		15.8	0.594		0.622
L7	6		6.6	0.236		0.260
M		4.5			0.177	
M1		4			0.157	
Dia	3.65		3.85	0.144		0.152

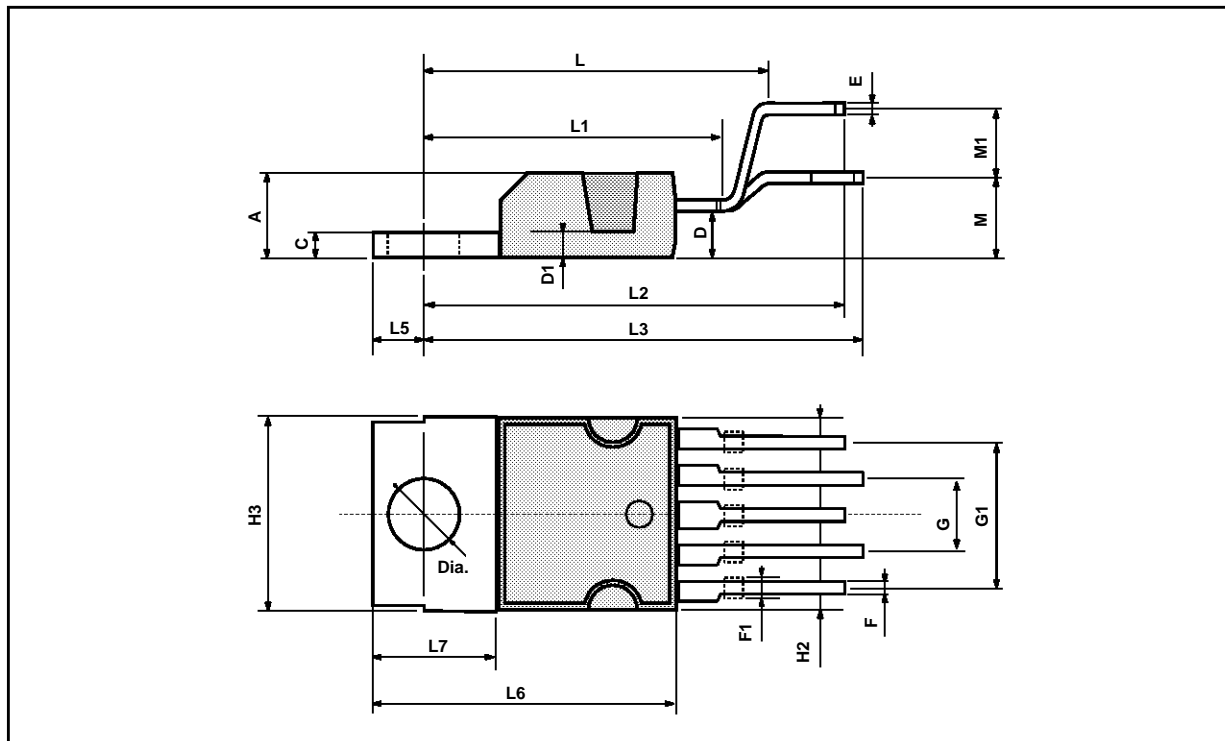

Information furnished is believed to be accurate and reliable. However, SGS-THOMSON Microelectronics assumes no responsibility for the consequences of use of such information nor for any infringement of patents or other rights of third parties which may result from its use. No license is granted by implication or otherwise under any patent or patent rights of SGS-THOMSON Microelectronics. Specifications mentioned in this publication are subject to change without notice. This publication supersedes and replaces all information previously supplied. SGS-THOMSON Microelectronics products are not authorized for use as critical components in life support devices or systems without express written approval of SGS-THOMSON Microelectronics.

© 1994 SGS-THOMSON Microelectronics - All Rights Reserved

SGS-THOMSON Microelectronics GROUP OF COMPANIES

Australia - Brazil - France - Germany - Hong Kong - Italy - Japan - Korea - Malaysia - Malta - Morocco - The Netherlands - Singapore - Spain - Sweden - Switzerland - Taiwan - Thailand - United Kingdom - U.S.A.