HA22039

GaAs IC Low Distortion Mixer for Micro Wave Application

HITACHI

ADE-207-271 (Z)
Preliminary
1st. Edition
August 1999

Features

- Suitable for low distortion of Micro Wave Application
- Low voltage and low current operation (3V, 7mA typ.)
- Low insertion loss (1.0 dB typ. @800MHz)
- Small surface mount package (MPAK-6)

Outline

MPAK-6

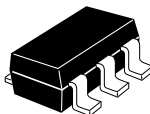

This Device is sensitive to Electro Static Discharge.
An Adequate handling procedure is requested.

CAUTION

This product uses GaAs. Since dust or fume of GaAs is highly poisonous to human body, please do not treat them mechanically in the manner which might expose to the Air. And it should never be thrown out with general industrial or domestic wastes.

HA22039

Absolute Maximum Ratings (Ta = 25°C)

Item	Symbol	Ratings	Unit
Supply voltage	Vdd	5	V
Maximum current	Idd	60	mA
Power dissipation	Pd	100	mW
Channel temperature	Tch	150	°C
Storage temperature	Tstg	-55 to +125	°C
Operation temperature	Topr	-30 to +85	°C

Electrical Characteristics (Ta = 25°C, Vdd = 3V, Idd = 7mA)

Item	Symbol	Min	Typ	Max	Unit	Test Conditions
Insertion loss	CL	0	1	3	dB	f = 800 MHz, PRF = -10dBm, Plo = 0dBm

Typical Performance (Ta = 25°C, Vdd = 3V, Idd = 7mA)

Item	Symbol	Typ	Unit	Test Conditions
3rd order input intercept point	IP3in	12	dBm	f = 800 MHz, PRF = -10dBm, Plo = 0dBm
Noise Figure (DSB)	NF	7	dB	

Block Diagram

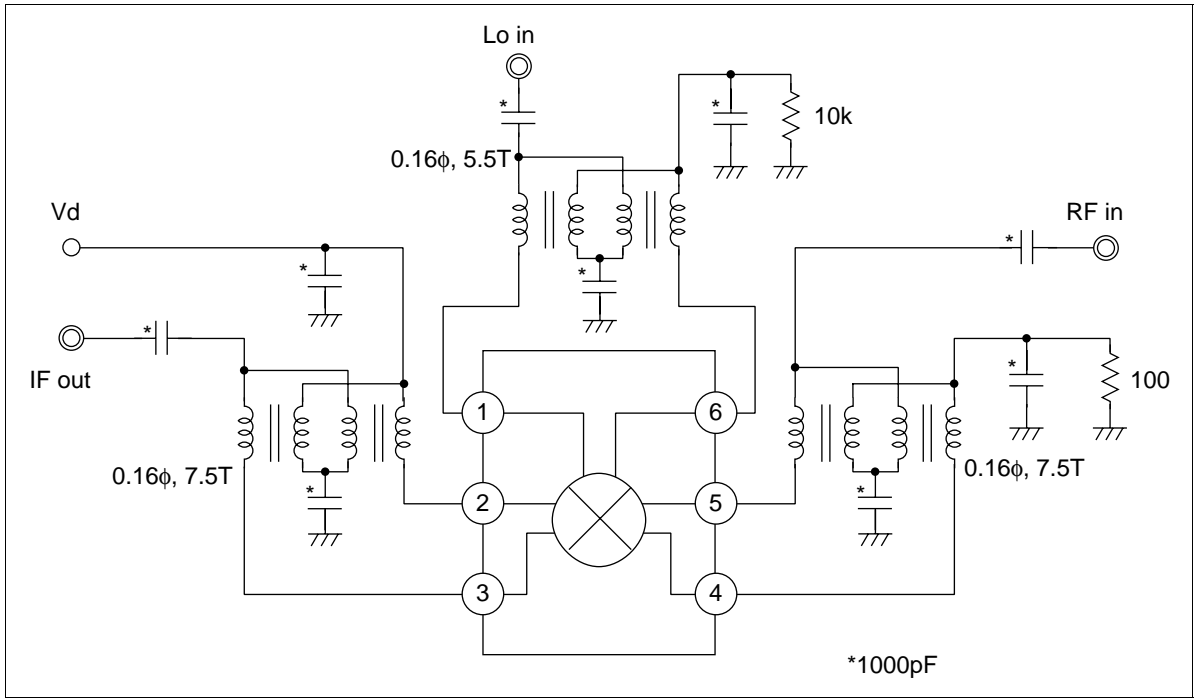

HA22039

Pin Arrangement

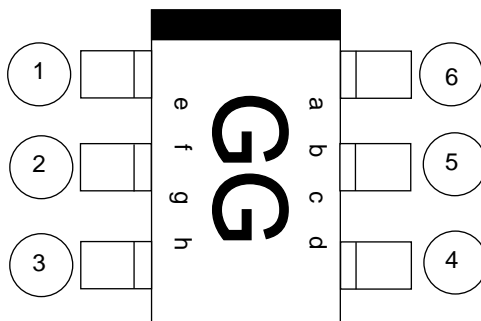

Top View

GG : Mark Type
a to d : Year Code (variable)
e to f : Monthly Code (variable)

Pin No.	Pin name	Function
1	G1	Gate
2	D1	Drain
3	D2	Drain
4	S2	Source
5	S1	Source
6	G2	Gate

Pattern Layout

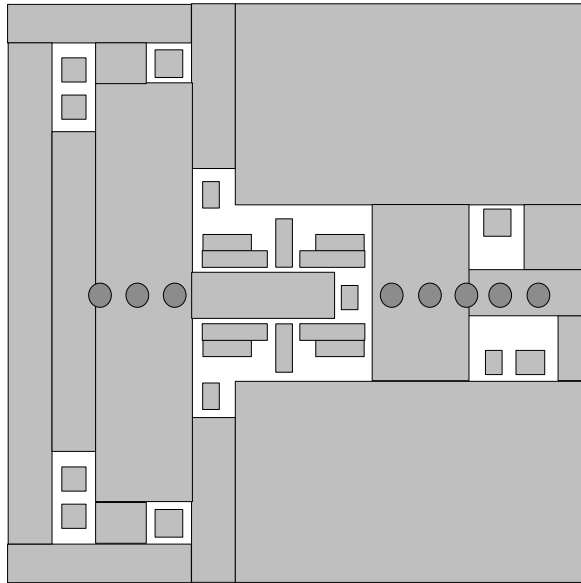

Front Side view of PCB Pattern

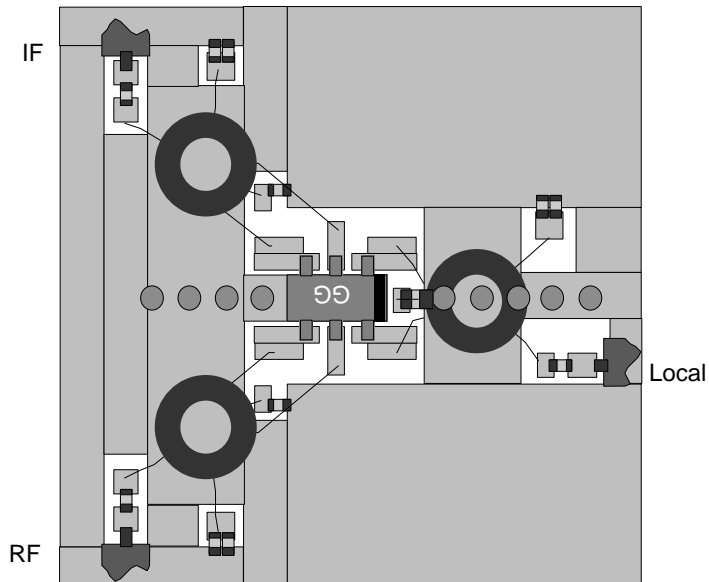

Front Side view of Part Layout

Main Characteristics

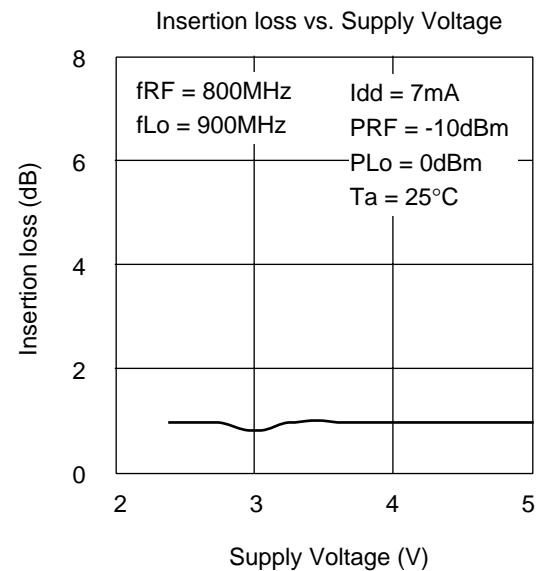
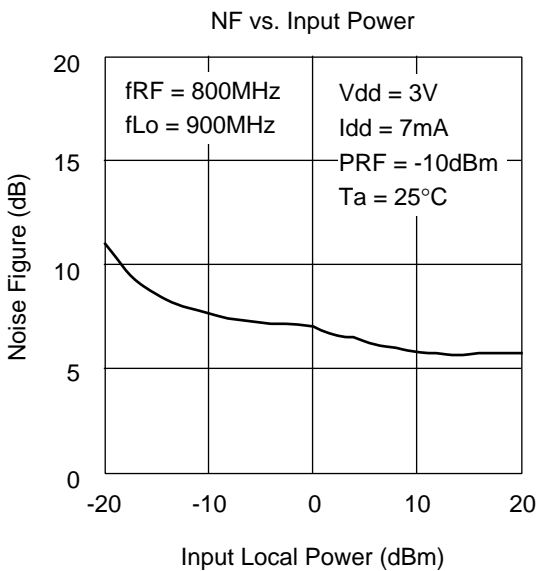
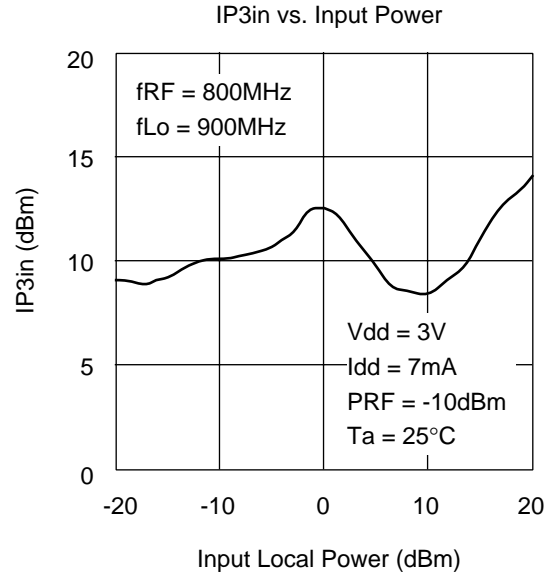
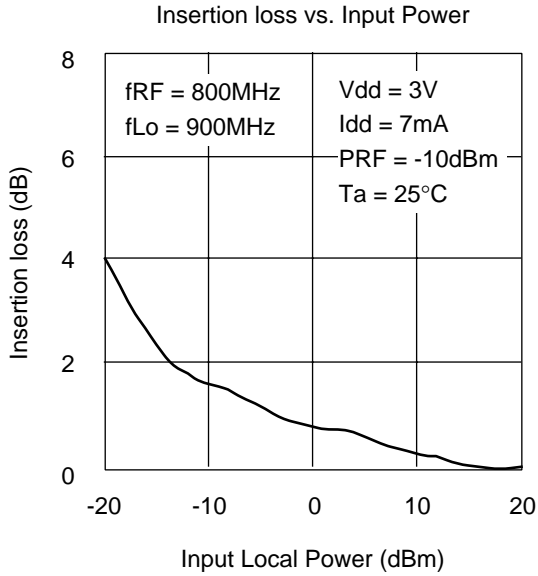

IP3in vs. Supply Voltage

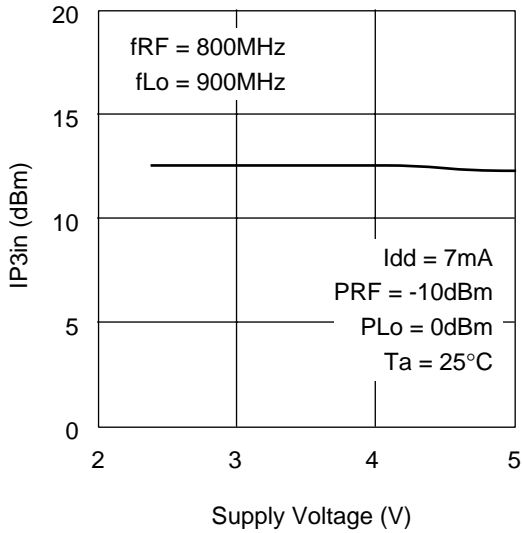

NF vs. Supply Voltage

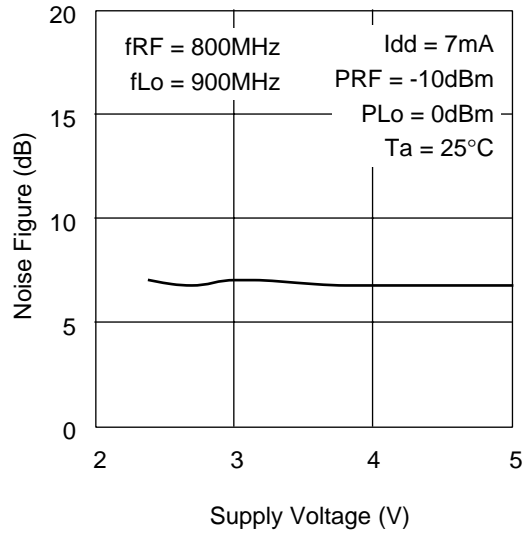

Insertion loss vs. Operation current

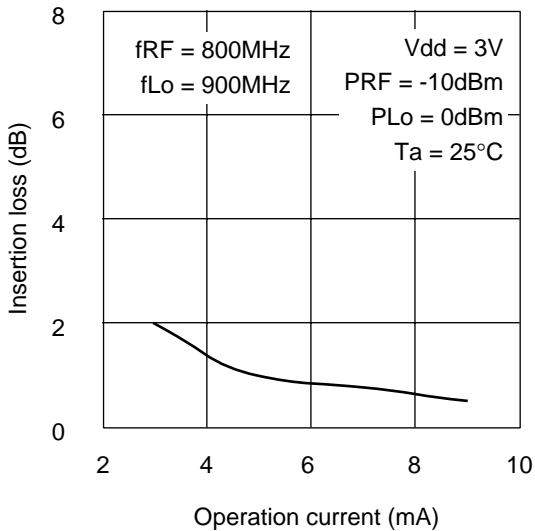

IP3in vs. Operation current

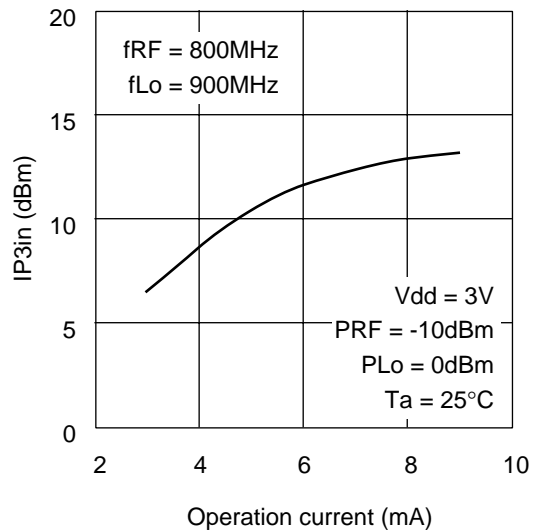

NF vs. Operation current

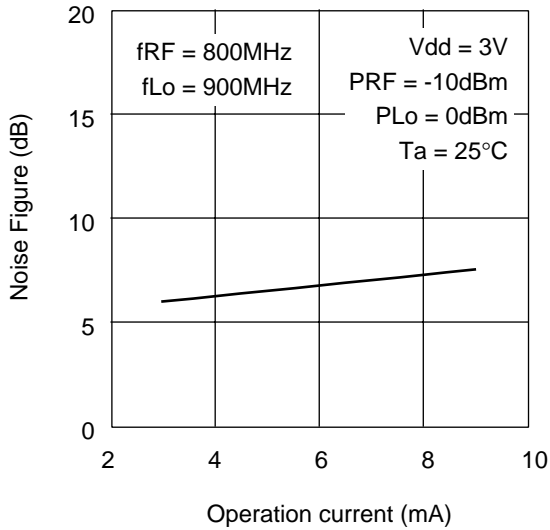

Insertion loss vs. Temperature

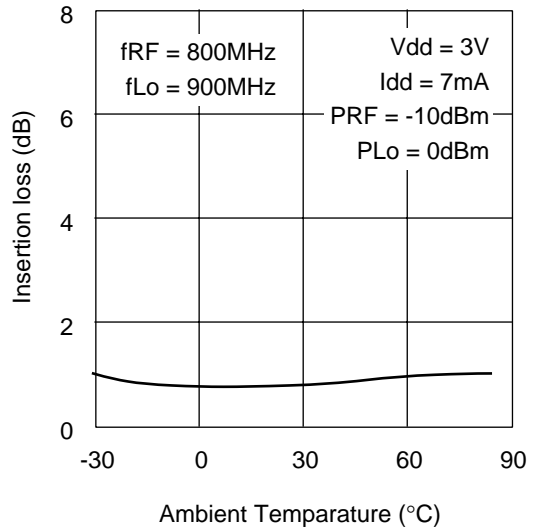

IP3in vs. Temperature

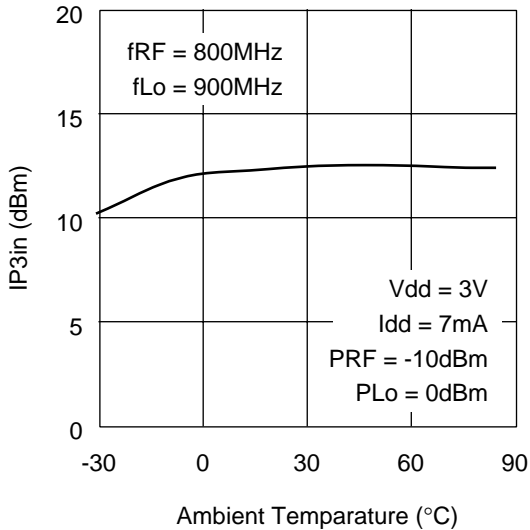

NF vs. Temperature

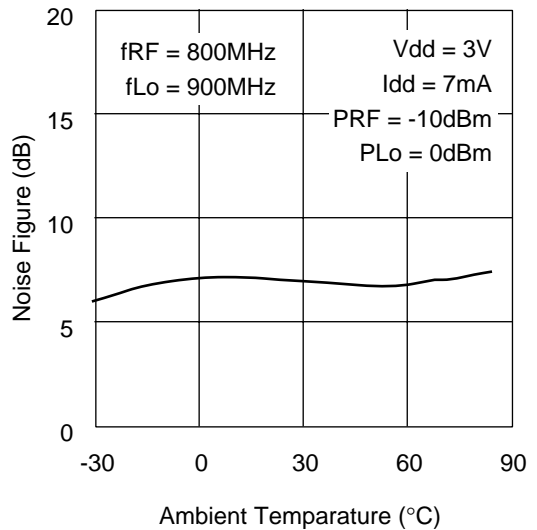

Insertion loss vs. Input Power

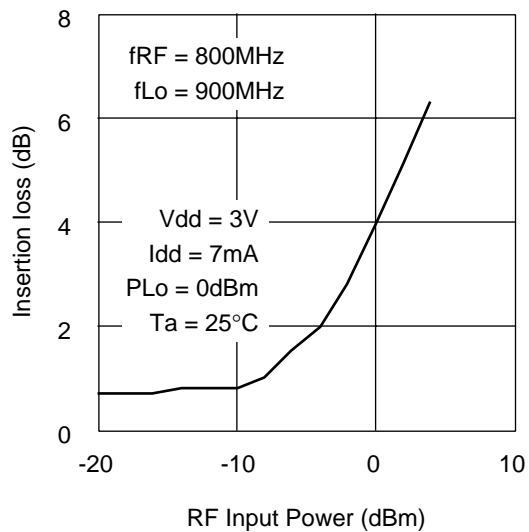

IP3in vs. Input Power

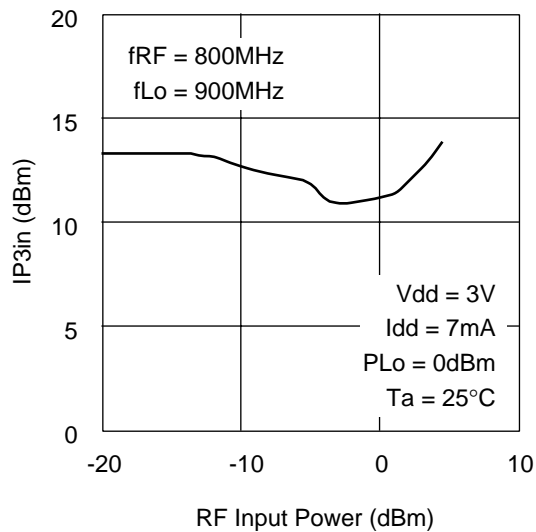

HA22039

Package Dimentions

Unit: mm

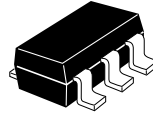
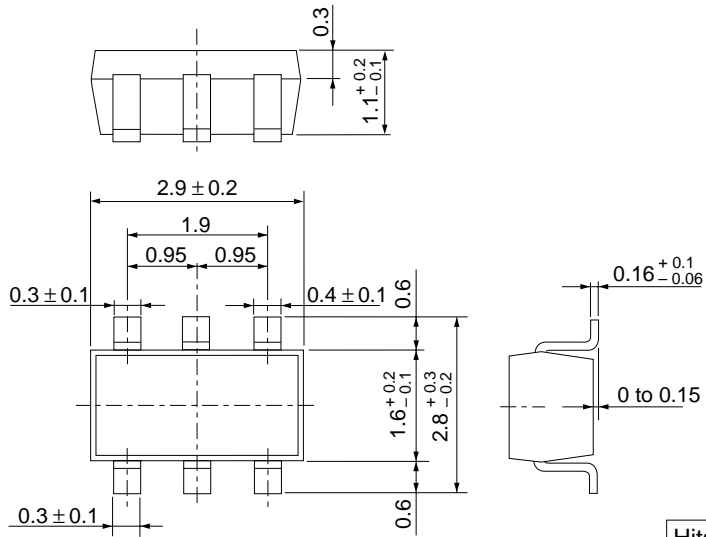

Hitachi Code	MPAK-6
EIAJ	—
JEDEC	—

Cautions

1. Hitachi neither warrants nor grants licenses of any rights of Hitachi's or any third party's patent, copyright, trademark, or other intellectual property rights for information contained in this document. Hitachi bears no responsibility for problems that may arise with third party's rights, including intellectual property rights, in connection with use of the information contained in this document.
2. Products and product specifications may be subject to change without notice. Confirm that you have received the latest product standards or specifications before final design, purchase or use.
3. Hitachi makes every attempt to ensure that its products are of high quality and reliability. However, contact Hitachi's sales office before using the product in an application that demands especially high quality and reliability or where its failure or malfunction may directly threaten human life or cause risk of bodily injury, such as aerospace, aeronautics, nuclear power, combustion control, transportation, traffic, safety equipment or medical equipment for life support.
4. Design your application so that the product is used within the ranges guaranteed by Hitachi particularly for maximum rating, operating supply voltage range, heat radiation characteristics, installation conditions and other characteristics. Hitachi bears no responsibility for failure or damage when used beyond the guaranteed ranges. Even within the guaranteed ranges, consider normally foreseeable failure rates or failure modes in semiconductor devices and employ systemic measures such as fail-safes, so that the equipment incorporating Hitachi product does not cause bodily injury, fire or other consequential damage due to operation of the Hitachi product.
5. This product is not designed to be radiation resistant.
6. No one is permitted to reproduce or duplicate, in any form, the whole or part of this document without written approval from Hitachi.
7. Contact Hitachi's sales office for any questions regarding this document or Hitachi semiconductor products.

1. This product must not be placed in the mouth, as it contains toxic substances that may cause poisoning. If by chance the product is placed in the mouth, take emergency action such as inducing vomiting, then consult a physician without delay.
2. Disposal of this product must be handled, separately from other general refuse, by a specialist processing contractor in the same way as dangerous items.

HITACHI

Hitachi, Ltd.

Semiconductor & Integrated Circuits.
Nippon Bldg., 2-6-2, Ohte-machi, Chiyoda-ku, Tokyo 100-0004, Japan
Tel: Tokyo (03) 3270-2111 Fax: (03) 3270-5109

URL NorthAmerica : <http://semiconductor.hitachi.com/>
Europe : <http://www.hitachi-eu.com/hel/ecg>
Asia (Singapore) : <http://www.has.hitachi.com.sg/grp3/sicd/index.htm>
Asia (Taiwan) : http://www.hitachi.com.tw/E/Product/SICD_Frame.htm
Asia (HongKong) : <http://www.hitachi.com.hk/eng/bo/grp3/index.htm>
Japan : <http://www.hitachi.co.jp/Sicd/indx.htm>

For further information write to:

Hitachi Semiconductor
(America) Inc.
179 East Tasman Drive,
San Jose, CA 95134
Tel: <1> (408) 433-1990
Fax: <1>(408) 433-0223

Hitachi Europe GmbH
Electronic components Group
Dornacher StraÙe 3
D-85622 Feldkirchen, Munich
Germany
Tel: <49> (89) 9 9180-0
Fax: <49> (89) 9 29 30 00

Hitachi Europe Ltd.
Electronic Components Group.
Whitebrook Park
Lower Cookham Road
Maidenhead
Berkshire SL6 8YA, United Kingdom
Tel: <44> (1628) 585000
Fax: <44> (1628) 778322

Hitachi Asia Pte. Ltd.
16 Collyer Quay #20-00
Hitachi Tower
Singapore 049318
Tel: 535-2100
Fax: 535-1533

Hitachi Asia Ltd.
Taipei Branch Office
3F, Hung Kuo Building, No.167,
Tun-Hwa North Road, Taipei (105)
Tel: <886> (2) 2718-3666
Fax: <886> (2) 2718-8180

Hitachi Asia (Hong Kong) Ltd.
Group III (Electronic Components)
7/F., North Tower, World Finance Centre,
Harbour City, Canton Road, Tsim Sha Tsui,
Kowloon, Hong Kong
Tel: <852> (2) 735 9218
Fax: <852> (2) 730 0281
Telex: 40815 HITEC HX