

## 16-Channel GPS Receiver Module

---

### Description

The GXB1000 is a 16-channel GPS receiver module. The GXB1000 is a small and light device, and it includes all the functions required for GPS except for the antenna.

The GXB1000 can support the various kinds of the portable applications as well as the car navigation system.

### Features

- 16-channel GPS receiver capable of simultaneously receiving 16 satellites
- All-in-view measurement
- 2-satellite measurement
- D-GPS (Differential GPS)
  - RTCM SC104 version 2.1
  - DARC BTA R-003 standard
- Low current consumption (275mW, typ.)
- Small and light package type
- The countermeasure of EMI (electromagnetic wave impediment)

### Recommended Operating Conditions

- Supply voltage (3V spec.)  $V_{DD}$  3.0 to 3.6 V
- (5V spec.)  $V_{CC}$  4.5 to 5.5 V
- Operating temperature  $T_{opr}$  -40 to +85 °C

GPS (Global Positioning System) is the position measurement system that the U.S. control and operate. It have some possibility of the position measurement deterioration that depends on the working GPS.  
It dose not gurantee the standard,etc in this material including the case above.

Sony reserves the right to change products and specifications without prior notice. This information does not convey any license by any implication or otherwise under any patents or other right. Application circuits shown, if any, are typical examples illustrating the operation of the devices. Sony cannot assume responsibility for any problems arising out of the use of these circuits.

## Specification

### Specification of reception unit

Reception method		Parallel 16 channels
RF input	Reception frequency	1575.42MHz L1 band, C/A code
	Characteristics impedance	50Ω
	Reception sensitivity	-130dBm or less (Sony's recommended antenna input level)
Positioning system		WGS-84
Positioning accuracy	Position	100m 2DRMS (SA ON, PDOP = 2.5, HDOP = 1.5)
	Velocity	0.9m/s (SA ON, PDOP = 2.5, HDOP = 1.5)
Positioning condition		A) DOP limit 3D: PDOP ≤ 12 2D: HDOP ≤ 6 B) Elevation mask: 5° or more
Follow-up performance	Velocity	500km/h or less
	Acceleration	2G or less
Measured data update time		Every 1s
D-GPS function		DARC BTA R-003 standard RTCM SC104 version 2.1 (6 of 8 format) Using type 1 data for correct calculation
Measurement method		All-in-view measurement 2-satellite measurement

**TTF (No signal break) \*1**

Hot Start (time, position, with ephemeris and almanac)

7 to 20s

Warm Start (time, position, without ephemeris, with almanac)

33 to 50s

Cold Start (time, position, without ephemeris and almanac)

35 to 60s

Reacquisition Time (interrupt recovery time)

The case of the interrupt less than 5 minutes 2 to 6s

The case of the interrupt more than 5 minutes 6 to 10s

\*1 Condition: The case of meeting positioning condition and receiving 8 satellites continuously and normally.

**Conditions of Cold Start**

Abnormal RAM data and abnormal RTC data for the command input

**RF input connector**

JST: CN connector

**I/O connector (Power supply, data mode)**

JST: SM10B-SRSS

**Communication Specification**

Communication method	Start-stop synchronization
Transfer rate input/output	9600bps
Electric level	TTL level
I/O code	ASCII code
Communication format	Sony/NMEA0183 switching possible

**Electrical Specification**

Supply voltage (3V spec.)	3.1 to 3.6V Ripple 50mVp-p or less
(5V spec.)	4.5 to 5.5V Ripple 50mVp-p or less
Current consumption	83mA typ. ( $V_{cc} = 3.3V, 25^{\circ}C$ )
Backup supply voltage	1.8 to 3.0V
current	30 $\mu$ A typ. ( $+B = 3.0V, 25^{\circ}C$ ) 70 $\mu$ A max. ( $+B = 3.0V, 85^{\circ}C$ )
Pre-amplifier power supply	2.7 to 3.6V, 10 to 30mA
Operating temperature	-40 to +85 $^{\circ}C$

## I/O Connector Pin

## Pin Configuration

Pin No.	Symbol	I/O	Description
1	Vcc	—	Main power supply.
2	RESET	I	Reset input for initializing the reception unit.
3	TXD0	O	Measured data output.
4	RXD0	I	Command input.
5	RXD1	I	D-GPS data input.
6	MODE	I	Communication format switching pin. (L = Sony, H = NMEA0183)
7	NC	—	Fixed H level.
8	+BU	—	Power supply for backup.
9	NC	—	No connection.
10	GND	—	GND

## Electrical Characteristics

(Topr = -40 to +85°C)

Item	Symbol	Conditions	Min.	Typ.	Max.	Unit	Applicable pins
Supply voltage	3V spec.	V <sub>DD</sub>	3.0	3.3	3.6	V	1
	5V spec.	V <sub>CC</sub>	4.5	5.0	5.5		
Input voltage	H level	V <sub>IH</sub>	0.7V <sub>DD</sub>		5.5	V	2, 4, 5
	L level	V <sub>IL</sub>			0.2V <sub>DD</sub>		
Output voltage	H level	V <sub>OH</sub>	I <sub>OH</sub> = -4mA	V <sub>DD</sub> - 0.8		V	3
	L level	V <sub>OL</sub>	I <sub>OL</sub> = 4mA		0.4		
Backup supply voltage			1.8		3.0	V	8
Current consumption at backup		+BU = 3V	5	30	70	μA	8

**Antenna Pre-amplifier Power Supply Circuit**

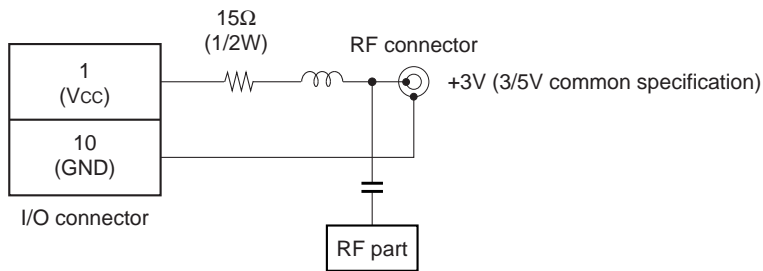

**Sony Recommend Antenna Specification**

**Antenna part**

Center frequency	1575.42MHz
Polarization	Right handed circular polarization
Gain	-5dBi or more (5° ≤ Angle of elevation)
Axis ratio	3dB typ. (Angle of elevation = 90°)

**Pre-amplifier part**

Gain	22dB or more (without cable loss)
Noise figure (NF)	2.5dB or less

**All-round specification (antenna + pre-amplifier + cable loss)**

Gain	17dBi or more (Angle of elevation = 90°)
Output impedance	50Ω
Output VSWR	2.0 or less
Supply voltage	2.8 to 3.2V
Current consumption	30mA or less

**Reception Unit Initialization and Operation**

The GXB1000 operation is started by setting the reset input signal RESET (Pin 2) for the reception unit initialization to high level. The timing should satisfy the conditions noted below.

**During Power-on (power-on reset)**

$V_{DD} = 3.0$  to  $3.6V$ ,  $V_{CC} = 4.5$  to  $5.5V$ , temperature =  $-40$  to  $+85^{\circ}C$

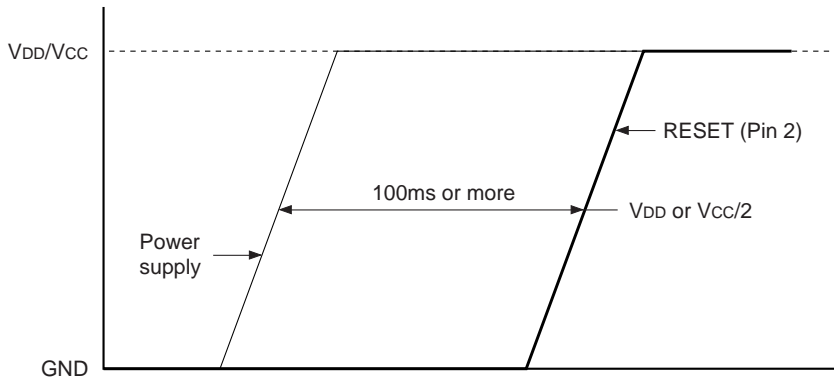

**Initialization During Operation**

$V_{DD} = 3.0$  to  $3.6V$ ,  $V_{CC} = 4.5$  to  $5.5V$ , temperature =  $-40$  to  $+85^{\circ}C$

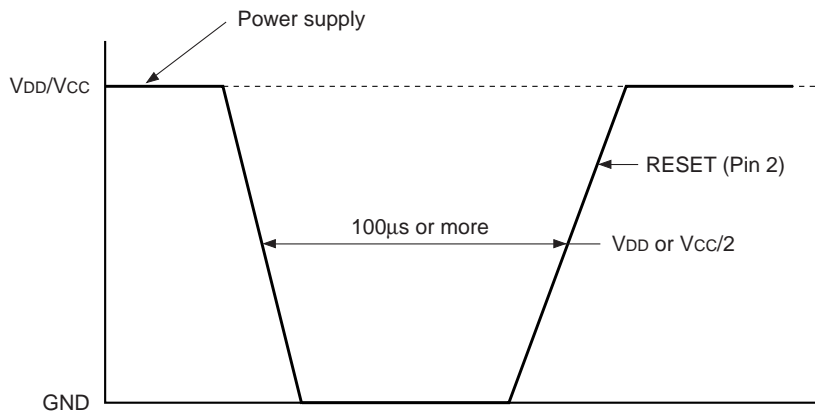

GXB1000 GPS Reception Unit Composition

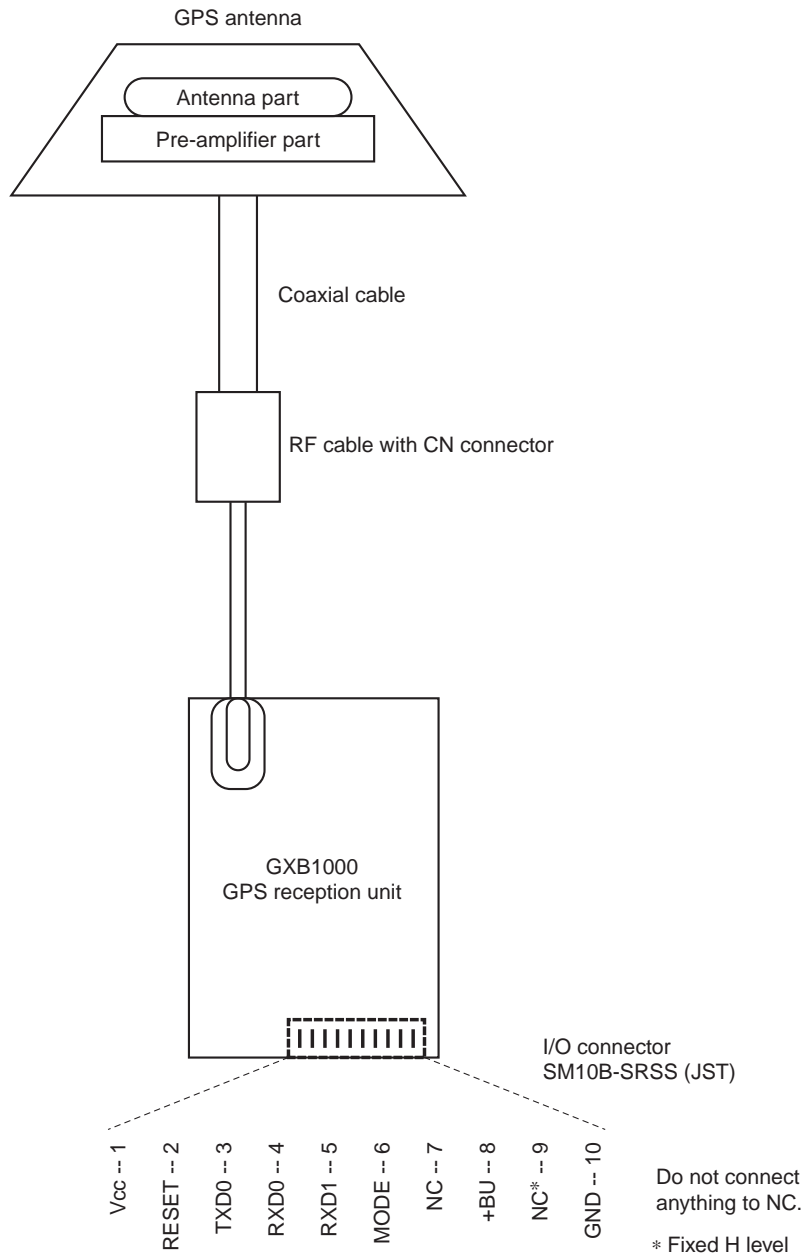

**GXB1000 GPS Reception Unit External Figure (Connector type)**

**Specification of form name**

GXB10○○-□□□C

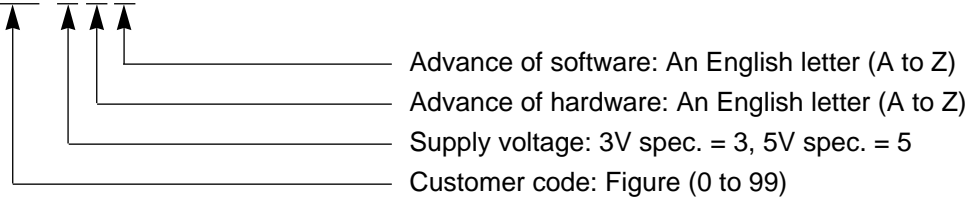

**Package Outline Unit: mm**

Quality of case materials: JIS63303  
 Electroplated tin

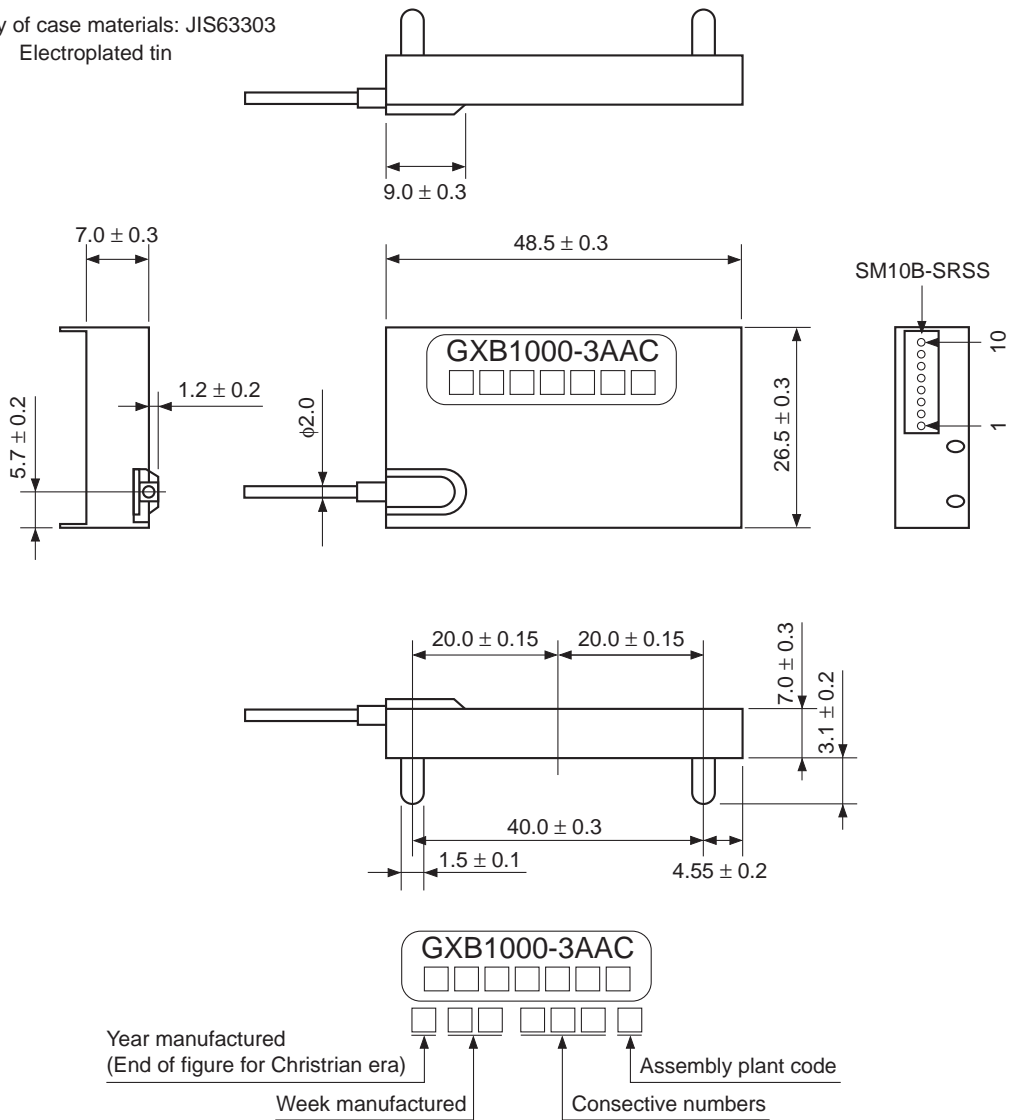



**GXB1000 GPS Reception Unit External Figure (Pin type)**

**Specification of form name**

GXB10○○-□□□P

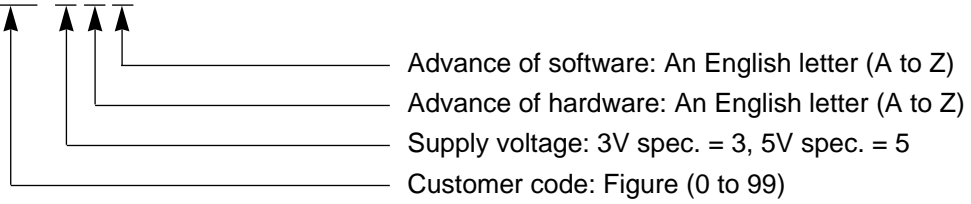

**Package Outline Unit: mm**

Quality of case materials: JIS63303  
 Electroplated tin

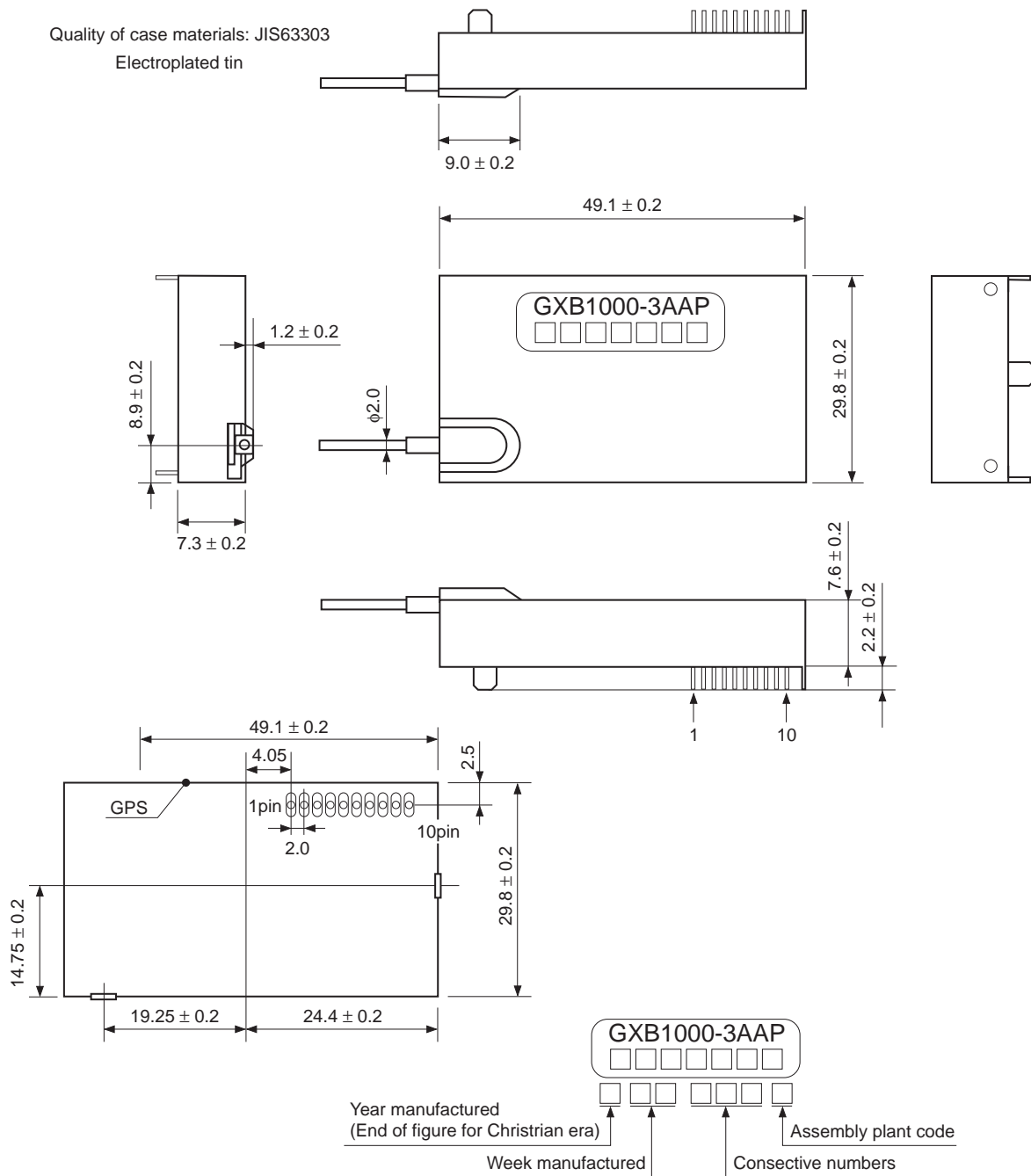

**GPS Receiver  
Data Input/Output Specifications**

**Contents**

1. I/O Data Input/Output Specifications ..... S-2

2. D-GPS Data Input Specifications ..... S-16

## 1. I/O Data Input/Output Specifications

### 1-1. Communication

#### 1-1-1. Serial input/output communication method

Interface:	Asynchronous serial interface (UART)
Baud rate:	9600 bps
Start bit:	1 bit
Data bits:	8 bits
Stop bit:	1 bit
Parity bit:	None
Communication control signal:	None
Output period:	Approximately 1s

#### 1-1-2. Asynchronous serial interface

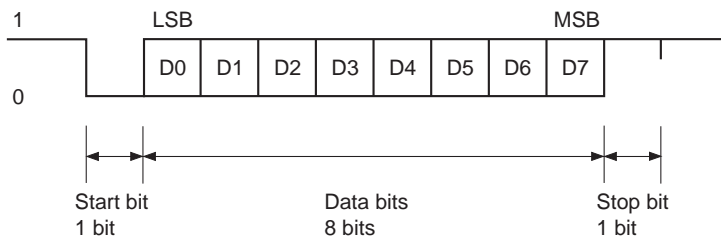

1-2. Output Data

1-2-1. Standard output

No.	BIT 76543210	Contents	Example	
			Setting value	Output data (HEX)
1	11010000	Header	—	D0
2	0xxxxxxx	Software version information	01	01
3	0xxxxxxx	Latitude	North latitude 87° 29' 10.24" (= 314950.24")	0F
4	0xxxxxxx	Resolution: 0.01"		02
5	0xxxxxxx	South latitude is two's complement notation.		26
6	0xxxxxxx	Value range: 32400000 to -32400000		70
7	0xxxxxxx	Longitude	West longitude 175° 42' 30.11" (= -632550.11")	61
8	0xxxxxxx	Resolution: 0.01"		6B
9	0xxxxxxx	West longitude is two's complement notation.		1C
10	0xxxxxxx	Value range: 64800000 to -64800000		1D
11	0xxxxxxx	Altitude	3775m	00
12	0xxxxxxx	Resolution: 1m Negative altitude is two's complement notation. Value range: 8191 to -8191		1D 3F
13	0xxxxxxx	Speed	60.5km/h	04
14	0xxxxxxx	Resolution: 0.1km/h Value range: 0 to 5150		5D
15	0xxxxxxx	Direction	310.7°	18
16	0xxxxxxx	Resolution: 0.1° Value range: 0 to 3599		23
17	0xxxxxxx	PDOP value	51.2	04
18	0xxxxxxx	Resolution: 0.1 Value range: 0 to 999		00
19	0xxxxxxx	Current time mode 0: UTC time 1: JST time	1	01
20	0xxxxxxx	Current time Year	1999	0F
21	0xxxxxxx	Year		4F
22	0xxxxxxx	Month		02
23	0xxxxxxx	Date		22
24	0xxxxxxx	Hour		12
25	0xxxxxxx	Minute		54
26	0xxxxxxx	Second		46
27	0xxxxxxx	Day		01
28	0xxxxxxx	Measurement calculation time Year	1999	0F
29	0xxxxxxx	Year		4F
30	0xxxxxxx	Month		02
31	0xxxxxxx	Date		22
32	0xxxxxxx	Hour		12
33	0xxxxxxx	Minute		55
34	0xxxxxxx	Second		30

No.	BIT 76543210	Contents	Example	
			Setting value	Output data (HEX)
35	0xxxxxxx	Number of visible satellites Value range: 0 to 32	8	08
36	0xxxxxxx	Satellite Nos. used for measurement 8 satellite Nos. Value range: 0 to 32 Satellite No.: 0 is invalid.	4	04
37	0xxxxxxx		10	0A
38	0xxxxxxx		18	12
39	0xxxxxxx		9	09
40	0xxxxxxx		20	14
41	0xxxxxxx		25	19
42	0xxxxxxx		7	07
43	0xxxxxxx	31	1F	
44	0xxxxxxx	Measurement calculation mode 0: Invalid 1: 2-satellite measurement 2: 3-satellite measurement 3: 4-(or more) satellite measurement	1	01
45	0xxxxxxx	Geodesic system Value range: 0 to 25	18	12
46	0xxxxxxx	Measurement delay time Resolution: 0.1s Value range: 0 to 9	0.4s	04
Information for 1st satellite				
47	0xxxxxxx	Satellite No. Value range: 0 to 32	16	10
48	0xxxxxxx	Azimuth Resolution: 1° Value range: 0 to 359°	218°	01
49	0xxxxxxx			5A
50	0xxxxxxx	Angle of elevation Resolution: 1° Value range: 0 to 90°	56°	38
51	0xxxxxxx	Reception status 0: Searching 1: Acquired 2: Usable for calculation 3: Radio waves cut off; interpolating 4: Satellite Unhealth 5: Currently being used for position calculation	3	03
52	0xxxxxxx	Signal level Resolution: 1dBHz Value range: 0 to 100	100	64
53 to		Information for 2nd satellite		
59 to		Information for 3rd satellite		
65 to		Information for 4th satellite		
71 to		Information for 5th satellite		

No.	BIT 76543210	Contents	Example	
			Setting value	Output data (HEX)
77 to		Information for 6th satellite		
83 to		Information for 7th satellite		
89 to		Information for 8th satellite		
95 to		Information for 9th satellite		
101 to		Information for 10th satellite		
107 to		Information for 11th satellite		
113 to		Information for 12th satellite		
119 to		Information for 13th satellite		
125 to		Information for 14th satellite		
131 to		Information for 15th satellite		
137 to		Information for 16th satellite		
143 to	0xxxxxxx	Preamplifier check 0: Normal, 1: Disconnected, 2: Short circuit	2	02
144 to		Reserved		
150	1101101	Terminator. "Z" + 80H	—	DA

1-2-2. Expanded output

No.	BIT 76543210	Contents	Example	
			Setting value	Output data (HEX)
150	0xxxxxxx	Latitude 0.001 to 0.0001" value Value range: 0 to 99	0.0025"	19
151	0xxxxxxx	Longitude 0.001 to 0.0001" value Value range: 0 to 99	0.0091"	5B
152	0xxxxxxx	Speed 0.01 km/h value Value range: 0 to 9	0.03km/h	03
153	0xxxxxxx	Number of healthy satellites Value range: 0 to 32	15	0F
154	0xxxxxxx	Not related to user	—	—
155	0xxxxxxx		—	—
156	0xxxxxxx		—	—
157	0xxxxxxx	Not related to user	—	—
158	0xxxxxxx	Not related to user	—	—
159	0xxxxxxx	SVACC Value range: 0 to 15	13	0D
160	0xxxxxxx	Error major axis radius (1 $\sigma$ estimated error) Resolution: 1m Value range: 0 to 510	130	01
161	0xxxxxxx			02
162	0xxxxxxx	Error minor axis radius (1 $\sigma$ estimated error) Resolution: 1m Value range: 0 to 510	41	00
163	0xxxxxxx			29
164	0xxxxxxx	Error major axis inclination Resolution: 1° Value range: 0 to 179 Angle clockwise from north	165	01
165	0xxxxxxx			25
166	0xxxxxxx	HDOP value Resolution: 0.1 Value range: 0 to 999	51.2	04
167	0xxxxxxx			00
168	0xxxxxxx	VDOP value Resolution: 0.1 Value range: 0 to 999	51.2	04
169	0xxxxxxx			00
170	0xxxxxxx	D-GPS measurement flag 0: Invalid 1: GPS measurement 2: D-GPS measurement	1	01
171	0xxxxxxx	D-GPS station No. Value range: 0 to 1023	1023	07
172	0xxxxxxx			7F
173	0xxxxxxx	D-GPS data elapsed time Resolution: 1s	1	01

No.	BIT 76543210	Contents	Example	
			Setting value	Output data (HEX)
174	0xxxxxxx	DARC/RTCM mode 0: DARC 1: RTCM	1	01
175	0xxxxxxx	PDOP limit value when D-GPS is on	1	01
176	0xxxxxxx	HDOP limit value when D-GPS is on	1	01
177	0xxxxxxx	PDOP limit value when D-GPS is off	1	01
178	0xxxxxxx	HDOP limit value when D-GPS is off	1	01
179	0xxxxxxx	Angle of elevation limit value	1	01
180	0xxxxxxx	Speed limit value	1	00
181	0xxxxxxx			01
182 to		Reserved		
190	1101101	Terminator. "Z" + 80H	—	DA



1-2-3. Almanac data output

No.	BIT 76543210	Contents	Example	
			Setting value	Output data (HEX)
1	10100100	Header		A4
2	0xxxxxxx			
.	.			
.	.			
.	.			
.	.			
.	.			
44	0xxxxxxx			
45	11011010	Terminator. "Z" + 80H	—	DA

After the receiver receives an almanac output request, it transmits a response and then outputs the almanac data. The above format is for 1 subframe of the almanac data, and 64 frames of this data are sent in succession. Almanac communication data is sent by dividing the original data into 7-bit sections.

The almanac data stored in the GPS receiver memory has the configuration shown below. Normally each word of the almanac data has 6-bit parity, but this is eliminated when the data is stored in the memory. In addition, a 16-bit checksum is added in consideration of communication.

WORD1	24 bits
WORD2	24 bits
WORD3	24 bits
WORD4	24 bits
WORD5	24 bits
WORD6	24 bits
WORD7	24 bits
WORD8	24 bits
WORD9	24 bits
WORD10	24 bits
Checksum	16 bits

The relationship between the above data and the communication data is shown to the right.

(1) Relationship between word data and communication data

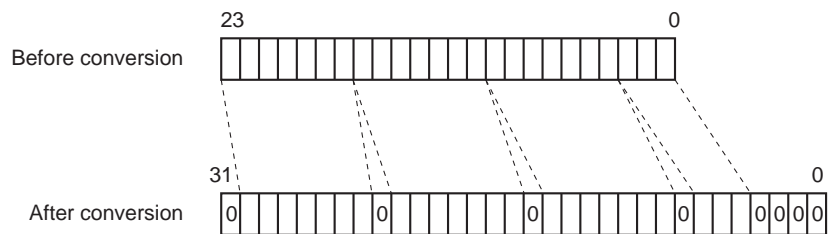

(2) Relationship between checksum and communication data

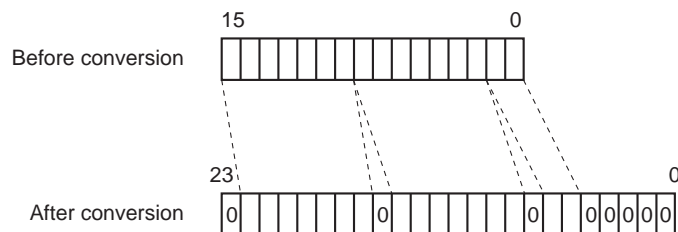

1-3. Input Data

1-3-1. TM command (receiver clock setting)

No.	BIT 76543210	Contents	Example	
			Setting value	Input data (HEX)
1	10100000	Header	—	A0
2	0xxxxxxx	Year	1999	0F
3	0xxxxxxx			4F
4	0xxxxxxx	Month	10	0A
5	0xxxxxxx	Date	29	1D
6	0xxxxxxx	Hour	8	08
7	0xxxxxxx	Minute	46	2E
8	0xxxxxxx	Second	59	3B
9	11011010	Terminator. "Z" + 80H	—	DA

After receiving the above command, the GPS side sends this command as a response.

1-3-2. PT command (receiver latitude and longitude initial value settings)

No.	BIT 76543210	Contents	Example	
			Setting value	Input data (HEX)
1	10100001	Header	—	A1
2	0xxxxxxx	Latitude Resolution: 0.01" South latitude is two's complement notation. Value range: 32400000 to -32400000	North latitude 87° 29' 10.24" (= 314950.24")	0F
3	0xxxxxxx			02
4	0xxxxxxx			26
5	0xxxxxxx			70
6	0xxxxxxx			Longitude Resolution: 0.01" West longitude is two's complement notation. Value range: 64800000 to -64800000
7	0xxxxxxx	6B		
8	0xxxxxxx	1C		
9	0xxxxxxx	1D		
10	11011010	Terminator. "Z" + 80H	—	DA

After receiving the above command, the GPS side sends this command as a response.

**1-3-3. SK command (receiver geodesic system parameter setting)**

No.	BIT 76543210	Contents	Example	
			Setting value	Input data (HEX)
1	10100010	Header	—	A2
2	0xxxxxxx	Geodesic system Value range: 0 to 25	18	12
3	11011010	Terminator. "Z" + 80H	—	DA

After receiving the above command, the GPS side sends this command as a response.

**1-3-4. AMI command (receive almanac data)**

No.	BIT 76543210	Contents	Example	
			Setting value	Input data (HEX)
1	10100011	Header	—	A3
2	11011010	Terminator. "Z" + 80H	—	DA

After receiving the above command, the GPS side sends this command as a response. The NAVI (PC) side receives this command and then sends the almanac data to the GPS side.

**1-3-5. AMO command (transmit almanac data)**

No.	BIT 76543210	Contents	Example	
			Setting value	Input data (HEX)
1	10100100	Header	—	A4
2	11011010	Terminator. "Z" + 80H	—	DA

After receiving the above command, the GPS side sends this command as a response, followed by the almanac data.

**1-3-6. CD command (initialize almanac data area and cold start)**

No.	BIT 76543210	Contents	Example	
			Setting value	Input data (HEX)
1	10100101	Header	—	A5
2	11011010	Terminator. "Z" + 80H	—	DA

After receiving the above command, the GPS side sends this command as a response.

**1-3-7. SR command (wait 400ms and hot start)**

No.	BIT 76543210	Contents	Example	
			Setting value	Input data (HEX)
1	10100110	Header	—	A6
2	11011010	Terminator. "Z" + 80H	—	DA

After receiving the above command, the GPS side sends this command as a response.

**1-3-8. EL command (angle of elevation limit value setting)**

No.	BIT 76543210	Contents	Example	
			Setting value	Input data (HEX)
1	10100111	Header	—	A7
2	0xxxxxxx	Angle of elevation Resolution: 1° Value range: 0 to 90°	56°	38
3	11011010	Terminator. "Z" + 80H	—	DA

After receiving the above command, the GPS side sends this command as a response.

**1-3-9. BC command (clear DARC receive data)**

No.	BIT 76543210	Contents	Example	
			Setting value	Input data (HEX)
1	10101000	Header	—	A8
2	11011010	Terminator. "Z" + 80H	—	DA

After receiving the above command, the GPS side sends this command as a response.

**1-3-10. DG command (D-GPS on/off setting)**

No.	BIT 76543210	Contents	Example	
			Setting value	Input data (HEX)
1	10101001	Header	—	A9
2	0xxxxxxx	D-GPS on/off setting 0: Off 1: On	1	01
3	11011010	Terminator. "Z" + 80H	—	DA

After receiving the above command, the GPS side sends this command as a response.

**1-3-11. GS command (4 DOP threshold value settings)**

No.	BIT 76543210	Contents	Example	
			Setting value	Input data (HEX)
1	10101010	Header	—	AA
2	0xxxxxxx	PDOP threshold value when D-GPS is on	64	40
3	0xxxxxxx	HDOP threshold value when D-GPS is on	50	32
4	0xxxxxxx	PDOP threshold value when D-GPS is off	64	40
5	0xxxxxxx	HDOP threshold value when D-GPS is off	50	32
6	11011010	Terminator. "Z" + 80H	—	DA

After receiving the above command, the GPS side sends this command as a response.

**1-3-12. DMD command (DARC data input mode)**

No.	BIT 76543210	Contents	Example	
			Setting value	Input data (HEX)
1	10101011	Header	—	AB
2	11011010	Terminator. "Z" + 80H	—	DA

After receiving the above command, the GPS side sends this command as a response.

**1-3-13. DMR command (RTCM data input mode)**

No.	BIT 76543210	Contents	Example	
			Setting value	Input data (HEX)
1	10101100	Header	—	AC
2	11011010	Terminator. "Z" + 80H	—	DA

After receiving the above command, the GPS side sends this command as a response.

**1-3-14. EX command (expanded output mode on/off)**

No.	BIT 76543210	Contents	Example	
			Setting value	Input data (HEX)
1	10101101	Header	—	AD
2	0xxxxxxx	Expanded output on/off setting 0: Off 1: On	1	01
3	11011010	Terminator. "Z" + 80H	—	DA

After receiving the above command, the GPS side sends this command as a response.

**1-3-15. SW command (eliminate ephemeris and warm start)**

No.	BIT 76543210	Contents	Example	
			Setting value	Input data (HEX)
1	10101110	Header	—	AE
2	11011010	Terminator. "Z" + 80H	—	DA

After receiving the above command, the GPS side sends this command as a response.

**1-3-16. TC command (current time mode setting)**

No.	BIT 76543210	Contents	Example	
			Setting value	Input data (HEX)
1	10101111	Header	—	AF
2	0xxxxxxx	Current time mode setting 0: UTC 1: JST	1	01
3	11011010	Terminator. "Z" + 80H	—	DA

After receiving the above command, the GPS side sends this command as a response.

**1-3-17. CH command (satellite No. setting during manual setting)**

No.	BIT 76543210	Contents	Example	
			Setting value	Input data (HEX)
1	11000000	Header	—	C0
2	0xxxxxxx	Satellite Nos. for 16 channels Value range: 1 to 64 0 is invalid.	9	09
3	0xxxxxxx		5	05
4	0xxxxxxx		18	12
5	0xxxxxxx		1	01
6	0xxxxxxx		20	14
7	0xxxxxxx		2	02
8	0xxxxxxx		6	06
9	0xxxxxxx		12	0C
10	0xxxxxxx		—	—
11	0xxxxxxx		—	—
12	0xxxxxxx		—	—
13	0xxxxxxx		—	—
14	0xxxxxxx		—	—
15	0xxxxxxx		—	—
16	0xxxxxxx		—	—
17	0xxxxxxx		—	—
18	11011010		Terminator. "Z" + 80H	—

After receiving the above command, the GPS side sends this command as a response.

**1-3-18. LF command (D-GPS valid time setting)**

No.	BIT 76543210	Contents	Example	
			Setting value	Input data (HEX)
1	11000111	Header	—	C7
2	0xxxxxxx	D-GPS valid time Resolution: s		
3	0xxxxxxx			
4	11011010	Terminator. "Z" + 80H	—	DA

After receiving the above command, the GPS side sends this command as a response.

**1-3-19. EP1 command (receive ephemeris data)**

No.	BIT 76543210	Contents	Example	
			Setting value	Input data (HEX)
1	11001101	Header	—	CD
2	11011010	Terminator. "Z" + 80H	—	DA

After receiving the above command, the GPS side sends this command as a response. The NAVI (PC) side receives this command and then sends the ephemeris data to the GPS side.

**1-3-20. EP0 command (transmit ephemeris data)**

No.	BIT 76543210	Contents	Example	
			Setting value	Input data (HEX)
1	11001110	Header	—	CE
2	11011010	Terminator. "Z" + 80H	—	DA

After receiving the above command, the GPS side sends this command as a response, followed by the ephemeris data.

**1-3-21. VF command (heading filter value setting)**

No.	BIT 76543210	Contents	Example	
			Setting value	Input data (HEX)
1	10110001	Header	—	B2
2	0xxxxxxx	Heading filter value	999	07
3	0xxxxxxx	Resolution: 0.1km/h	(99.9km/h)	67
4	11011010	Terminator. "Z" + 80H	—	DA

After receiving the above command, the GPS side sends this command as a response.



## 2. D-GPS Data Input Specifications

### 2-1. Communication

#### 2-1-1. Serial input communication method

Interface:	Asynchronous serial interface (UART)
Baud rate:	9600 bps
Start bit:	1 bit
Data bits:	8 bits
Stop bit:	1 bit
Parity bit:	None
Communication control signal:	None
Input period:	1s or more

#### 2-1-2. Asynchronous serial interface

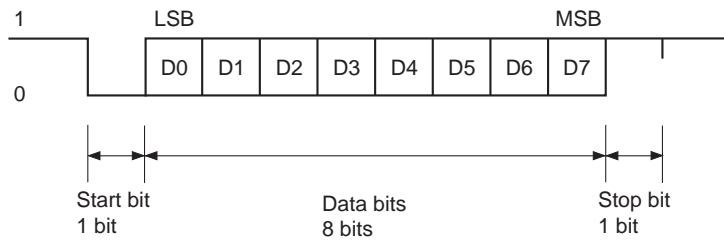

**2-2. RTCM Data Input**

RTCM data input conforms to the RTCM SC-104 format and supports message type 1.

The message type shared header and message type 1 format are shown below. These data are sent in the "6 of 8" format. In this format, each word is divided into 6-bit units, the bits are reordered so that the LSB comes first and the MSB comes last, and then "01" is added to the head of the bits.

**2-2-1. Message type shared header**

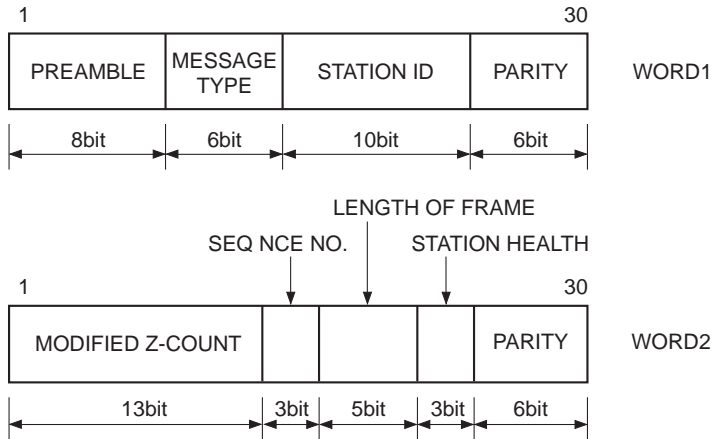

- PREAMBLE: Preamble
- MESSAGE TYPE: Message type
- STATION ID: Reference station ID No.
- PARITY: Error correction code
- MODIFIED Z-COUNT: Modified Z-count
- SEQ NCE NO.: Frame sequence No.
- LENGTH OF FRAME: Frame length
- STATION HEALTH: Reference station health

2-2-2. Message type 1 (differential GPS correction value)

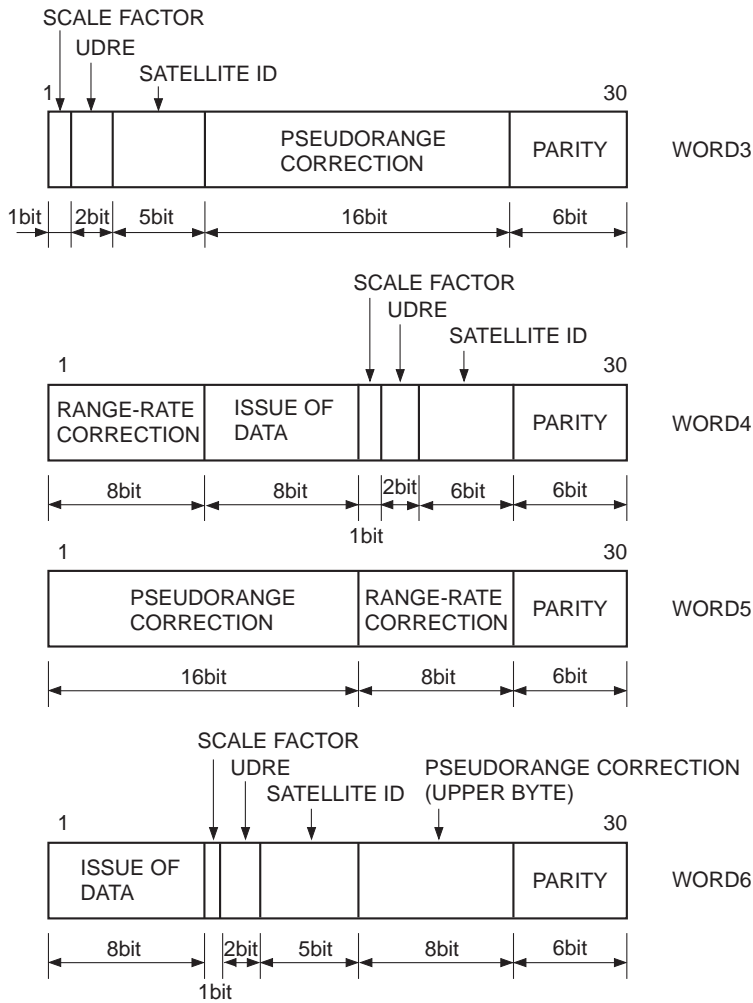

- SCALE FACTOR: Pseudorange correction value scale factor
- UDRE: User differential range error index
- SATELLITE ID: Satellite ID No.
- PSEUDORANGE CORRECTION: Pseudorange correction value
- RANGE-RATE CORRECTION: Pseudorange rate-of-change correction value
- ISSUE OF DATA: Data issue No.

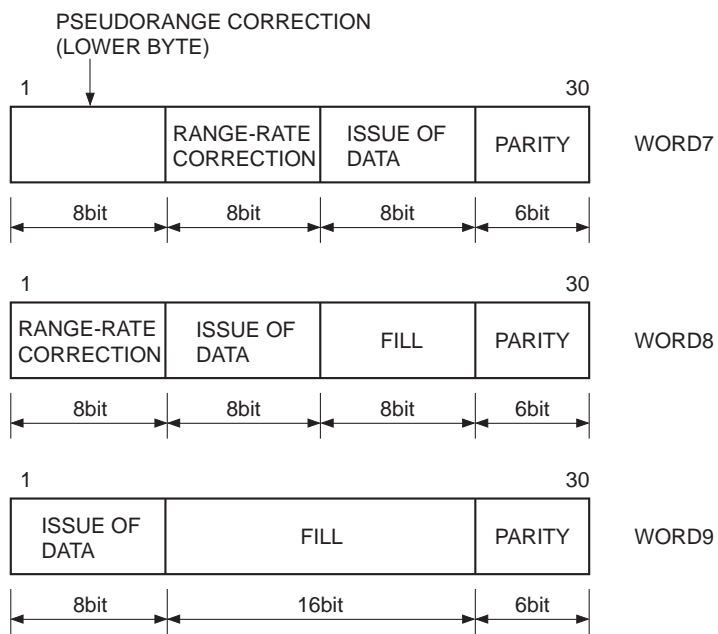

FILL: Dummy bit

**2-3. DARC Data Input**

DARC data is output in the communication format noted below. The D-GPS basic data is located in the D-GPS segments. The D-GPS basic data is comprised of 288 bits (36 bytes).

Data packet 1 22 bytes		Data packet 2 22 bytes			Checksum 1 byte	Terminator 1 byte
Prefix 4 bytes	D-GPS segment 18 bytes	Prefix 2 bytes	D-GPS segment 18 bytes	CRC 2 byte	xxh	0Dh

The D-GPS basic data configuration is as follows.

Bit position	Description	Number of bits
1 to 3	D-GPS data ID	3 bits
4	Correction time	1 bit
5 to 38	1st GPS satellite correction data	34 bits
39 to 72	2nd GPS satellite correction data	34 bits
73 to 106	3rd GPS satellite correction data	34 bits
107 to 140	4th GPS satellite correction data	34 bits
141 to 174	5th GPS satellite correction data	34 bits
175 to 208	6th GPS satellite correction data	34 bits
209 to 242	7th GPS satellite correction data	34 bits
243 to 276	8th GPS satellite correction data	34 bits
277 to 288	Communication data	12 bits

The GPS satellite correction data configuration is as follows.

Bit position	Description	Number of bits
1	Scale factor	1 bit
2 to 3	UDRE (User differential range error index)	2 bits
4 to 8	GPS satellite ID	5 bits
9 to 19	PRC (Pseudorange correction value)	11 bits
20 to 26	RRC (Pseudorange rate-of-change correction value)	7 bits
27 to 34	IODE (Ephemeris data issue No.)	8 bits

**Geodetic System and Corresponding Country**

Setting value	Geodetic system	Reference Ellipsoid	
0	WGS-84	WGS-84	
1	TOKYO	Bessel 1841	Japan, Korea
2	ADINDAN	Clarke 1880	Ethiopia, Mali, Senegal, Sudan
3	ARC 1950	Clarke 1880	Botswana, Lesotho, Malawi, Swaziland, Zaire, Zambia, Zimbabwe
	CAPE	Clarke 1880	South Africa
4	MERCHICH	Clarke 1880	Morocco
5	HONG KONG 1963	International	Hong Kong
6	SOUTH ASIA	Modified Fisher 1960	Singapore
7	LUZEN	Clarke 1866	Philippines
8	INDIAN	Everest	Thailand, Vietnam
9	INDIAN	Everest	Bangladesh, India, Nepal
10	KERTAU 1948	Modified Everest	West Malaysia, Singapore
11	NORTH AMERICAN 1927	Clarke 1866	Belize, Costa Rica, El Salvador, Guatemala, Honduras, Nicaragua, Mexico
12	EUROPEAN 1950 EUROPEAN 1950	International	Austria, Belgium, Cyprus, Channel Islands, Denmark, England, Finland, France, Germany, Gibraltar, Greece, Ireland, Italy, Luxembourg, Netherlands, Norway, Portugal, Scotland, Shetland Island, Spain, Sweden, Switzerland
13	IRELAND 1965	Modified Airy	Ireland
14	ORDNANCE SURVEY OF GREAT BRITAIN 1936	Airy	England, Isle of Man, Scotland, Shetland Island, Wales
15	NAHRWAN	Clarke 1880	Masirash Island, Oman, United Arab Emirates
16	NAHRWAN	Clarke 1880	Saudi Arabia
17	OLD EGYPTIAN	Helmert 1906	Egypt
18	NORTH AMERICAN 1927	Clarke 1866	Canada, Newfoundland Island
19	NORTH AMERICAN 1983	GRS 80	Alaska, Canada, Mexico, Central America, United States of America
20	AUSTRALIAN GEODETIC 1984	Australian National	Australia, Tasmania Island
21	GEODETIC DATUM 1949	International	New Zealand
22	PROVISIONAL SOUTH AMERICAN 1956	International	Bolivia, Chile, Colombia, Ecuador, Guyana, Peru, Venezuela
23	SOUTH AMERICAN 1969	South American 1969	Argentina, Bolivia, Brazil, Chile, Colombia, Ecuador, Guyana, Paraguay, Peru, Trinidad and Tobago, Venezuela
24	CAMPO INCHAUSPE	International	Argentina
25	CORREGO ALEGE	International	Brazil

**GPS Receiver  
NMEA-0183 Input/Output Specifications****Contents**

1. I/O Data Input/Output Specifications .....	SS-2
2. NMEA Output Specifications .....	SS-11
3. D-GPS Data Input Specifications .....	SS-27

## 1. I/O Data Input/Output Specifications

### 1-1. Communication

#### 1-1-1. Serial input/output communication method

Interface: Asynchronous serial interface (UART)  
 I/O channel: CH0  
 Baud rate: 4800bps  
 Start bit: 1 bit  
 Data bits: 8 bits  
 Stop bit: 1 bit  
 Parity bit: None  
 Communication control signal: None  
 Output period: Approximately 1s

#### 1-1-2. Asynchronous serial interface

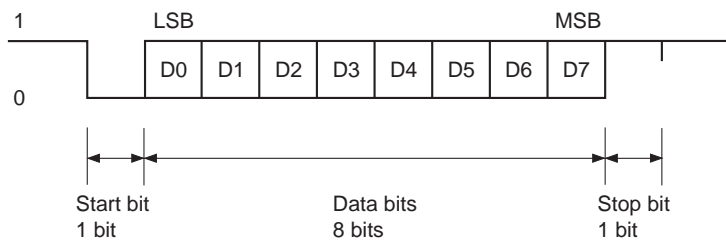



1-2. Almanac Data Output

No.	BIT 76543210	Contents	Example	
			Setting value	Output data (HEX)
1	10100100	Header		A4
2	0xxxxxxx			
·	·			
·	·			
·	·			
·	·			
·	·			
44	0xxxxxxx			
45	11011010	Terminator. "Z" + 80HEX	—	DA

After the receiver receives an almanac output request, it transmits a response and then outputs the almanac data. The above format is for 1 subframe of the almanac data, and 64 frames of this data are sent in succession. Almanac communication data is sent by dividing the original data into 7-bit sections.

The almanac data stored in the GPS receiver memory has the configuration shown below. Normally each word of the almanac data has 6-bit parity, but this is eliminated when the data is stored in the memory. In addition, a 16-bit checksum is added in consideration of communication.

WORD1	24 bits
WORD2	24 bits
WORD3	24 bits
WORD4	24 bits
WORD5	24 bits
WORD6	24 bits
WORD7	24 bits
WORD8	24 bits
WORD9	24 bits
WORD10	24 bits
Checksum	16 bits

(1) Relationship between word data and communication data

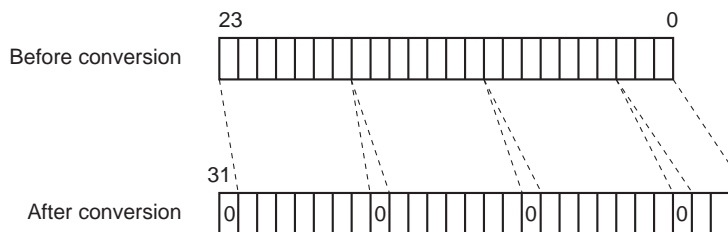

(2) Relationship between checksum and communication data

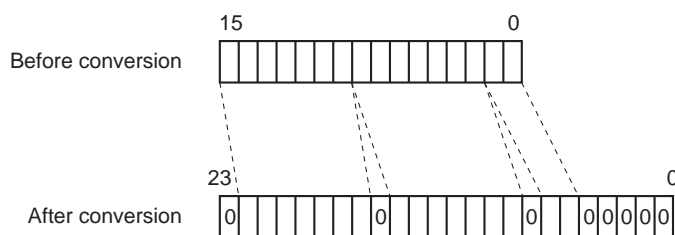

The relationship between the above data and the communication data is shown to the right.

1-3. Input Commands

1-3-1. TM command (receiver clock setting)

No.	BIT 76543210	Contents	Example	
			Setting value	Input data (HEX)
1	10100000	Header	—	A0
2	0xxxxxxx	Year	1999	0F
3	0xxxxxxx			4F
4	0xxxxxxx	Month	10	0A
5	0xxxxxxx	Date	29	1D
6	0xxxxxxx	Hour	8	08
7	0xxxxxxx	Minute	46	2E
8	0xxxxxxx	Second	59	3B
9	11011010	Terminator. "Z" + 80HEX	—	DA

After receiving the above command, the GPS side sends this command as a response.

1-3-2. PT command (receiver latitude and longitude initial value settings)

No.	BIT 76543210	Contents	Example	
			Setting value	Input data (HEX)
1	10100001	Header	—	A1
2	0xxxxxxx	Latitude Resolution: 0.01" South latitude is two's complement notation. Value range: 32400000 to -32400000	North latitude 87° 29' 10.24" (= -314950.24")	0F
3	0xxxxxxx			02
4	0xxxxxxx			26
5	0xxxxxxx			70
6	0xxxxxxx	Longitude Resolution: 0.01" West longitude is two's complement notation. Value range: 64800000 to -64800000	West longitude 175° 42' 30.11" (= -632550.11")	61
7	0xxxxxxx			6B
8	0xxxxxxx			1C
9	0xxxxxxx			1D
10	11011010	Terminator. "Z" + 80HEX	—	DA

After receiving the above command, the GPS side sends this command as a response.

**1-3-3. SK command (receiver geodesic system parameter setting)**

No.	BIT 76543210	Contents	Example	
			Setting value	Input data (HEX)
1	10100010	Header	—	A2
2	0xxxxxxx	Geodesic system Value range: 0 to 25	18	12
3	11011010	Terminator. "Z" + 80HEX	—	DA

After receiving the above command, the GPS side sends this command as a response.

**1-3-4. AMI command (receive almanac data)**

No.	BIT 76543210	Contents	Example	
			Setting value	Input data (HEX)
1	10100011	Header	—	A3
2	11011010	Terminator. "Z" + 80HEX	—	DA

After receiving the above command, the GPS side sends this command as a response. The NAVI (PC) side receives this command and then sends the almanac data to the GPS side.

**1-3-5. AMO command (transmit almanac data)**

No.	BIT 76543210	Contents	Example	
			Setting value	Input data (HEX)
1	10100100	Header	—	A4
2	11011010	Terminator. "Z" + 80HEX	—	DA

After receiving the above command, the GPS side sends this command as a response, followed by the almanac data.

**1-3-6. CD command (initialize almanac data area and cold start)**

No.	BIT 76543210	Contents	Example	
			Setting value	Input data (HEX)
1	10100101	Header	—	A5
2	11011010	Terminator. "Z" + 80HEX	—	DA

After receiving the above command, the GPS side sends this command as a response.

**1-3-7. SR command (wait 400ms and hot start)**

No.	BIT 76543210	Contents	Example	
			Setting value	Input data (HEX)
1	10100110	Header	—	A6
2	11011010	Terminator. "Z" + 80HEX	—	DA

After receiving the above command, the GPS side sends this command as a response.

**1-3-8. EL command (angle of elevation limit value setting)**

No.	BIT 76543210	Contents	Example	
			Setting value	Input data (HEX)
1	10100111	Header	—	A7
2	0xxxxxxx	Angle of elevation Resolution: 1° Value range: 0 to 90°	56°	38
3	11011010	Terminator. "Z" + 80HEX	—	DA

After receiving the above command, the GPS side sends this command as a response.

**1-3-9. BC command (clear DARC receive data)**

No.	BIT 76543210	Contents	Example	
			Setting value	Input data (HEX)
1	10101000	Header	—	A8
2	11011010	Terminator. "Z" + 80HEX	—	DA

After receiving the above command, the GPS side sends this command as a response.

**1-3-10. DG command (D-GPS on/off setting)**

No.	BIT 76543210	Contents	Example	
			Setting value	Input data (HEX)
1	10101001	Header	—	A9
2	0xxxxxxx	D-GPS on/off setting 0: Off 1: On	1	01
3	11011010	Terminator. "Z" + 80HEX	—	DA

After receiving the above command, the GPS side sends this command as a response.

**1-3-11. GS command (4 DOP threshold value settings (up to 99 (63HEX) max.))**

No.	BIT 76543210	Contents	Example	
			Setting value	Input data (HEX)
1	10101010	Header	—	AA
2 3	0xxxxxxx 0xxxxxxx	PDOP threshold value when D-GPS is on	64	00 40
4 5	0xxxxxxx 0xxxxxxx	HDOP threshold value when D-GPS is on	50	00 32
6 7	0xxxxxxx 0xxxxxxx	PDOP threshold value when D-GPS is off	135	01 07
8 9	0xxxxxxx 0xxxxxxx	HDOP threshold value when D-GPS is off	114	00 72
10	11011010	Terminator. "Z" + 80HEX	—	DA

After receiving the above command, the GPS side sends this command as a response.

**1-3-12. DMD command (DARC data input mode)**

No.	BIT 76543210	Contents	Example	
			Setting value	Input data (HEX)
1	10101011	Header	—	AB
2	11011010	Terminator. "Z" + 80HEX	—	DA

After receiving the above command, the GPS side sends this command as a response.

**1-3-13. DMR command (RTCM data input mode)**

No.	BIT 76543210	Contents	Example	
			Setting value	Input data (HEX)
1	10101100	Header	—	AC
2	11011010	Terminator. "Z" + 80HEX	—	DA

After receiving the above command, the GPS side sends this command as a response.

**1-3-14. EX command (expanded output mode on/off)**

No.	BIT 76543210	Contents	Example	
			Setting value	Input data (HEX)
1	10101101	Header	—	AD
2	0xxxxxxx	Expanded output on/off setting 0: Off 1: On	1	01
3	11011010	Terminator. "Z" + 80HEX	—	DA

After receiving the above command, the GPS side sends this command as a response.

**1-3-15. SW command (eliminate ephemeris and warm start)**

No.	BIT 76543210	Contents	Example	
			Setting value	Input data (HEX)
1	10101110	Header	—	AE
2	11011010	Terminator. "Z" + 80HEX	—	DA

After receiving the above command, the GPS side sends this command as a response.

**1-3-16. TC command (current time mode setting)**

No.	BIT 76543210	Contents	Example	
			Setting value	Input data (HEX)
1	10101111	Header	—	AF
2	0xxxxxxx	Current time mode setting 0: UTC 1: JST	1	01
3	11011010	Terminator. "Z" + 80HEX	—	DA

After receiving the above command, the GPS side sends this command as a response.

**1-3-17. CH command (satellite No. setting during manual setting)**

No.	BIT 76543210	Contents	Example	
			Setting value	Input data (HEX)
1	11000000	Header	—	C0
2	0xxxxxxx	Satellite Nos. for 16 channels Value range: 1 to 64 0 is invalid.	9	09
3	0xxxxxxx		5	05
4	0xxxxxxx		18	12
5	0xxxxxxx		1	01
6	0xxxxxxx		20	14
7	0xxxxxxx		2	02
8	0xxxxxxx		6	06
9	0xxxxxxx		12	0C
10	0xxxxxxx		—	—
11	0xxxxxxx		—	—
12	0xxxxxxx		—	—
13	0xxxxxxx		—	—
14	0xxxxxxx		—	—
15	0xxxxxxx		—	—
16	0xxxxxxx		—	—
17	0xxxxxxx		—	—
18	11011010		Terminator. "Z" + 80HEX	—

After receiving the above command, the GPS side sends this command as a response.

**1-3-18. LF command (D-GPS valid time setting)**

No.	BIT 76543210	Contents	Example	
			Setting value	Input data (HEX)
1	11000111	Header	—	C7
2	0xxxxxxx	D-GPS valid time Resolution: s		
3	0xxxxxxx			
4	11011010	Terminator. "Z" + 80HEX	—	DA

After receiving the above command, the GPS side sends this command as a response.

**1-3-19. EPI command (receive ephemeris data)**

No.	BIT 76543210	Contents	Example	
			Setting value	Input data (HEX)
1	11001101	Header	—	CD
2	11011010	Terminator. "Z" + 80HEX	—	DA

After receiving the above command, the GPS side sends this command as a response. The NAVI (PC) side receives this command and then sends the ephemeris data to the GPS side.

**1-3-20. EP0 command (transmit ephemeris data)**

No.	BIT 76543210	Contents	Example	
			Setting value	Input data (HEX)
1	11001110	Header	—	CE
2	11011010	Terminator. "Z" + 80HEX	—	DA

After receiving the above command, the GPS side sends this command as a response, followed by the ephemeris data.

**1-3-21. VF command (heading filter value setting)**

No.	BIT 76543210	Contents	Example	
			Setting value	Input data (HEX)
1	10110001	Header	—	B2
2	0xxxxxxx	Heading filter value	999	07
3	0xxxxxxx	Resolution: 0.1km/h	(99.9km/h)	67
4	11011010	Terminator. "Z" + 80HEX	—	DA

After receiving the above command, the GPS side sends this command as a response.



2. NMEA Output Specifications

2-1. Output Messages

2-1-1. GPGGA message

No.	BIT 76543210	Contents	Example	
			Setting value	Output data (HEX)
1	00100100	Header "\$"	Fixed	24
2	01000111	Address field "G"	Fixed	47
3	01010000	"P"		50
4	01000111	"G"		47
5	01000111	"G"		47
6	01000001	"A"		41
7	01001100	", "		Fixed
8	xxxxxxxx	UTC time Hour (10's digit)	06:22:43	00
9	xxxxxxxx	Hour (1's digit)		36
10	xxxxxxxx	Minute (10's digit)		32
11	xxxxxxxx	Minute (1's digit)		32
12	xxxxxxxx	Second (10's digit)		34
13	xxxxxxxx	Second (1's digit)		33
14	01001100	", "	Fixed	2C
15	xxxxxxxx	Latitude Degree (10's digit)	36° 03.979'	33
16	xxxxxxxx	Degree (1's digit)		36
17	xxxxxxxx	Minute (10's digit)		30
18	xxxxxxxx	Minute (1's digit)		33
19	00101110	". "		2E
20	xxxxxxxx	Minute (0.1's digit)		39
21	xxxxxxxx	Minute (0.01's digit)		37
22	xxxxxxxx	Minute (0.001's digit)		39
23	01001100	", "	Fixed	2C
24	xxxxxxxx	Latitude direction "N" or "S"	North latitude	4E
25	01001100	", "	Fixed	2C
26	xxxxxxxx	Longitude Degree (100's digit)	140° 10.296'	31
27	xxxxxxxx	Degree (10's digit)		34
28	xxxxxxxx	Degree (1's digit)		30
29	xxxxxxxx	Minute (10's digit)		31
30	xxxxxxxx	Minute (1's digit)		30
31	00101110	". "		2E
32	xxxxxxxx	Minute (0.1's digit)		32
33	xxxxxxxx	Minute (0.01's digit)		39
34	xxxxxxxx	Minute (0.001's digit)		36

No.	BIT 76543210	Contents	Example	
			Setting value	Output data (HEX)
35	01001100	" , "	Fixed	2C
36	xxxxxxx	Longitude direction "E" or "W"	West longitude	57
37	01001100	" , "	Fixed	2C
38	xxxxxxx	GPS Quality Indicator "0": Invalid "1": GPS measurement "2": D-GPS measurement	D-GPS measurement	32
39	01001100	" , "	Fixed	2C
40	xxxxxxx	Number of satellites used for measurement calculation "00" to "12"	7-satellite measurement	30
41	xxxxxxx			37
42	01001100	" , "	Fixed	2C
43	xxxxxxx	HDOP 10's digit 1's digit " . " 0.1's digit	1.2	30
44	xxxxxxx			31
45	00101110			2E
46	xxxxxxx			32
47	01001100	" , "	Fixed	2C
48	xxxxxxx	Altitude (m) 1,000's digit 100's digit 10's digit 1's digit	23m	30
49	xxxxxxx			30
50	xxxxxxx			32
51	xxxxxxx			33
52	01001100	" , "	Fixed	2C
53	01001101	Altitude units "M"	Fixed	4D
54	01001100	" , "	Fixed	2C
55	01001100	" , "	Fixed	2C
56	01001101	"M"	Fixed	4D
57	01001100	" , "	Fixed	2C
58	xxxxxxx	D-GPS data elapsed time (s) 100's digit 10's digit 1's digit	5s	30
59	xxxxxxx			30
60	xxxxxxx			35
61	01001100	" , "	Fixed	2C
62	xxxxxxx	D-GPS reference station ID 1,000's digit 100's digit 10's digit 1's digit	0	30
63	xxxxxxx			30
64	xxxxxxx			30
65	xxxxxxx			30
66	00101010	" * "	Fixed	2A

No.	BIT 76543210	Contents	Example	
			Setting value	Output data (HEX)
67	xxxxxxx	Checksum	4A	34
68	xxxxxxx	Hexadecimal upper digits		
		Hexadecimal lower digits		41
69	00001101	Terminator	Fixed	0D
70	00001010	<CR>		
		<LF>		0A

The Geoidal Separation parameter is not output (between No. 54 and No. 55).

2-1-2. GPGLL message

No.	BIT 76543210	Contents	Example		
			Setting value	Output data (HEX)	
1	00100100	Header "\$"	Fixed	24	
2	01000111	Address field "G"	Fixed	47	
3	01010000	"P"		50	
4	01000111	"G"		47	
5	01001100	"L"		4C	
6	01001100	"L"		4C	
7	01001100	", "		Fixed	2C
8	xxxxxxxx	Latitude Degree (10's digit)	36° 03.979'	33	
9	xxxxxxxx	Degree (1's digit)		36	
10	xxxxxxxx	Minute (10's digit)		30	
11	xxxxxxxx	Minute (1's digit)		33	
12	00101110	". "		2E	
13	xxxxxxxx	Minute (0.1's digit)		39	
14	xxxxxxxx	Minute (0.01's digit)		37	
15	xxxxxxxx	Minute (0.001's digit)		39	
16	01001100	", "		Fixed	2C
17	xxxxxxxx	Latitude direction "N" or "S"		North latitude	4E
18	01001100	", "		Fixed	2C
19	xxxxxxxx	Longitude Degree (100's digit)		140° 10.296'	31
20	xxxxxxxx	Degree (10's digit)			34
21	xxxxxxxx	Degree (1's digit)			30
22	xxxxxxxx	Minute (10's digit)			31
23	xxxxxxxx	Minute (1's digit)	30		
24	00101110	". "	2E		
25	xxxxxxxx	Minute (0.1's digit)	32		
26	xxxxxxxx	Minute (0.01's digit)	39		
27	xxxxxxxx	Minute (0.001's digit)	36		
28	01001100	", "	Fixed		2C
29	xxxxxxxx	Longitude direction "E" or "W"	West longitude		57
30	01001100	", "	Fixed		2C
31	xxxxxxxx	UTC time Hour (10's digit)	06:22:43		00
32	xxxxxxxx	Hour (1's digit)			36
33	xxxxxxxx	Minute (10's digit)			32
34	xxxxxxxx	Minute (1's digit)		32	
35	xxxxxxxx	Second (10's digit)		34	
36	xxxxxxxx	Second (1's digit)		33	
37	01001100	", "	Fixed	2C	

No.	BIT 76543210	Contents	Example	
			Setting value	Output data (HEX)
38	xxxxxxx	Status "A": Data valid "V": Data invalid	Valid	41
39	00101010	" * "	Fixed	2A
40	xxxxxxx	Checksum Hexadecimal upper digits	4A	34
41	xxxxxxx	Hexadecimal lower digits		41
42	00001101	Terminator <CR>	Fixed	0D
43	00001010	<LF>		0A

2-1-3. GPGSA message

No.	BIT 76543210	Contents	Example	
			Setting value	Output data (HEX)
1	00100100	Header "\$"	Fixed	24
2	01000111	Address field "G"	Fixed	47
3	01010000	"P"		50
4	01000111	"G"		47
5	01010011	"S"		53
6	01000001	"A"		41
7	01001100	", "		Fixed
8	xxxxxxxx	GPS measurement switching mode "M": Manual "A": Auto	Fixed to "A"	41
9	01001100	", "	Fixed	2C
10	xxxxxxxx	GPS measurement mode "1": Invalid "2": 2D measurement "3": 3D measurement	3D measurement	33
11	01001100	", "	Fixed	2C
12	xxxxxxxx	Satellite Nos. used for measurement 1st satellite No. 10's digit		
13	xxxxxxxx	1's digit		
14	01001100	", "		
15 to 17		2nd satellite No.		
18 to 20		3rd satellite No.		
21 to 23		4th satellite No.		
24 to 26		5th satellite No.		
27 to 29		6th satellite No.		
30 to 32		7th satellite No.		
33 to 35		8th satellite No.		
36 to 38		9th satellite No.		
39 to 41		10th satellite No.		
42 to 44		11th satellite No.		
45 to 47		12th satellite No.		
48	xxxxxxxx	PDOP 10's digit	2.4	30
49	xxxxxxxx	1's digit		32
50	00101110	". "		2E
51	xxxxxxxx	0.1's digit		34
52	01001100	", "	Fixed	2C

No.	BIT 76543210	Contents	Example	
			Setting value	Output data (HEX)
53	xxxxxxx	HDOP 10's digit	1.2	30
54	xxxxxxx	1's digit		31
55	00101110	" . "		2E
56	xxxxxxx	0.1's digit		32
57	01001100	" , "	Fixed	2C
58	xxxxxxx	VDOP 10's digit	2.0	30
59	xxxxxxx	1's digit		32
60	00101110	" . "		2E
61	xxxxxxx	0.1's digit		30
62	00101010	" * "	Fixed	2A
63	xxxxxxx	Checksum Hexadecimal upper digits	4A	34
64	xxxxxxx	Hexadecimal lower digits		41
65	00001101	Terminator <CR>	Fixed	0D
66	00001010	<LF>		0A

The data length for "Satellite Nos. used for measurement" is variable in order to output the numbers of all the satellites used for position measurement.

2-1-4. GPGSV message

No.	BIT 76543210	Contents	Example				
			Setting value	Output data (HEX)			
1	00100100	Header "\$"	Fixed	24			
2	01000111	Address field "G" "P" "G" "S" "V"	Fixed	47			
3	01010000			50			
4	01000111			47			
5	01010011			53			
6	01010110			56			
7	01001100			", "	Fixed	2C	
8	xxxxxxxx	Total number of GPGSV messages "1" to "3"	2	32			
9	01001100	", "	Fixed	2C			
10	xxxxxxxx	GPGSV message number "1" to "3"	1	31			
11	01001100	", "	Fixed	2C			
12	xxxxxxxx	Number of satellites within field of vision 10's digit 1's digit	08	30			
13	xxxxxxxx			38			
14	01001100	", "	Fixed	2C			
15	xxxxxxxx	Information on satellites within field of vision for four satellites Satellite No. 10's digit 1's digit " , " Angle of elevation (°) 10's digit 1's digit " , " Azimuth (°) 100's digit 10's digit 1's digit " , " C/N (dB) 10's digit 1's digit " , "					
16	xxxxxxxx						
17	01001100						
18	xxxxxxxx						
19	xxxxxxxx						
20	01001100						
21	xxxxxxxx						
22	xxxxxxxx						
23	xxxxxxxx						
24	01001100						
25	xxxxxxxx						
26	xxxxxxxx						
27	01001100						
28 to 40					Information for 2nd satellite		
41 to 53					Information for 3rd satellite		
54 to 56					Information for 4th satellite		
67	00101010				" * "	Fixed	2A
68	xxxxxxxx				Checksum Hexadecimal upper digits	4A	34
69	xxxxxxxx				Hexadecimal lower digits		41



No.	BIT 76543210	Contents	Example	
			Setting value	Output data (HEX)
70	00001101	Terminator <CR>	Fixed	0D
71	00001010	<LF>		0A

The satellite information for up to four satellites can be sent with a single GPGSV message, so multiple GPGSV messages (up to three messages) are sent when there are four or more satellites within the field of vision. When there are fewer than four satellites, the information for that number of satellites is sent.

## 2-1-5. GPRMC message

No.	BIT 76543210	Contents	Example	
			Setting value	Output data (HEX)
1	00100100	Header "\$"	Fixed	24
2	01000111	Address field "G"	Fixed	47
3	01010000	"P"		50
4	01010010	"R"		52
5	01001101	"M"		4D
6	01000011	"C"		43
7	01001100	", "		Fixed
8	xxxxxxxx	UTC time	06:22:43	
9	xxxxxxxx	Hour (10's digit)		00
10	xxxxxxxx	Hour (1's digit)		36
11	xxxxxxxx	Minute (10's digit)		32
12	xxxxxxxx	Minute (1's digit)		32
13	xxxxxxxx	Second (10's digit)		34
14	01001100	", "	Fixed	2C
15	xxxxxxxx	Status "A": Data valid "V": Data invalid	Valid	41
16	01001100	", "	Fixed	2C
17	xxxxxxxx	Latitude	36° 03.979'	
18	xxxxxxxx	Degree (10's digit)		33
19	xxxxxxxx	Degree (1's digit)		36
20	xxxxxxxx	Minute (10's digit)		30
21	xxxxxxxx	Minute (1's digit)		33
22	00101110	". "		2E
23	xxxxxxxx	Minute (0.1's digit)		39
24	xxxxxxxx	Minute (0.01's digit)		37
25	xxxxxxxx	Minute (0.001's digit)		39
26	01001100	", "		Fixed
27	xxxxxxxx	Latitude direction "N" or "S"	North latitude	4E
28	01001100	", "	Fixed	2C
28	xxxxxxxx	Longitude	140° 10.296'	
29	xxxxxxxx	Degree (100's digit)		31
30	xxxxxxxx	Degree (10's digit)		34
31	xxxxxxxx	Degree (1's digit)		30
32	xxxxxxxx	Minute (10's digit)		31
33	xxxxxxxx	Minute (1's digit)		30
34	00101110	". "		2E
35	xxxxxxxx	Minute (0.1's digit)		32
36	xxxxxxxx	Minute (0.01's digit)		39
37	xxxxxxxx	Minute (0.001's digit)		36

No.	BIT 76543210	Contents	Example	
			Setting value	Output data (HEX)
37	01001100	", "	Fixed	2C
38	xxxxxxx	Longitude direction "E" or "W"	West longitude	57
39	01001100	", "	Fixed	2C
40	xxxxxxx	Speed (knots) 100's digit	20knot/h	30
41	xxxxxxx	10's digit		32
42	xxxxxxx	1's digit		30
43	00101110	". "		2E
44	xxxxxxx	0.1's digit		30
45	01001100	", "	Fixed	2C
46	xxxxxxx	Heading (°) 100's digit	48.5°	30
47	xxxxxxx	10's digit		34
48	xxxxxxx	1's digit		38
49	00101110	". "		2E
50	xxxxxxx	0.1's digit		35
51	01001100	", "	Fixed	2C
52	xxxxxxx	Date 10's digit	July 13, 1999	31
53	xxxxxxx	1's digit Month		33
54	xxxxxxx	10's digit		30
55	xxxxxxx	1's digit Year		37
56	xxxxxxx	10's digit		39
57	xxxxxxx	1's digit		39
58	01001100	", "		Fixed
59	01001100	", "	Fixed	2C
60	00101010	" * "	Fixed	2A
61	xxxxxxx	Checksum Hexadecimal upper digits	4A	34
62	xxxxxxx	Hexadecimal lower digits		41
63	00001101	Terminator <CR>	Fixed	0D
64	00001010	<LF>		0A

The Magnetic Variation parameter is not output.  
(between No. 58 and No. 59, and between No. 59 and No. 60)

2-1-6. GPVTG message

No.	BIT 76543210	Contents	Example	
			Setting value	Output data (HEX)
1	00100100	Header "\$"	Fixed	24
2	01000111	Address field "G"	Fixed	47
3	01010000	"P"		50
4	01010110	"V"		56
5	01010100	"T"		54
6	01000111	"G"		47
7	01001100	", "		Fixed
8	xxxxxxxx	Heading (°) 100's digit	48.5°	30
9	xxxxxxxx	10's digit		34
10	xxxxxxxx	1's digit		38
11	00101110	". "		2E
12	xxxxxxxx	0.1's digit		35
13	01001100	", "	Fixed	2C
14	01010100	"T"	Fixed	54
15	01001100	", "	Fixed	2C
16	01001100	", "	Fixed	2C
17	01001101	"M"	Fixed	4D
18	01001100	", "	Fixed	2C
19	xxxxxxxx	Speed (knots) 100's digit	20knot/h	30
20	xxxxxxxx	10's digit		32
21	xxxxxxxx	1's digit		30
22	00101110	". "		2E
23	xxxxxxxx	0.1's digit		30
24	01001100	", "	Fixed	2C
25	01001110	"N"	Fixed	4E
26	01001100	", "	Fixed	2C
27	xxxxxxxx	Speed (km/h) 100's digit	20km/h	30
28	xxxxxxxx	10's digit		32
29	xxxxxxxx	1's digit		30
30	00101110	". "		2E
31	xxxxxxxx	0.1's digit		30
32	01001100	", "	Fixed	2C
33	01001011	"K"	Fixed	4B
34	00101010	" * "	Fixed	2A
35	xxxxxxxx	Checksum Hexadecimal upper digits	4A	34
36	xxxxxxxx	Hexadecimal lower digits		41

No.	BIT 76543210	Contents	Example	
			Setting value	Output data (HEX)
37	00001101	Terminator <CR>	Fixed	0D
38	00001010	<LF>		0A

The Course Over Ground and Degree Magnetic parameters are not output.  
(between No. 15 and No. 16)

2-1-7. GPZDA message

No.	BIT 76543210	Contents	Example	
			Setting value	Output data (HEX)
1	00100100	Header "\$"	Fixed	24
2	01000111	Address field "G"	Fixed	47
3	01010000	"P"		50
4	01011010	"Z"		5A
5	01000100	"D"		44
6	01000001	"A"		41
7	01001100	", "		Fixed
8	xxxxxxxx	UTC time Hour (10's digit)	06:22:43	00
9	xxxxxxxx	Hour (1's digit)		36
10	xxxxxxxx	Minute (10's digit)		32
11	xxxxxxxx	Minute (1's digit)		32
12	xxxxxxxx	Second (10's digit)		34
13	xxxxxxxx	Second (1's digit)		33
14	01001100	", "	Fixed	2C
15	xxxxxxxx	Date 10's digit	13th	31
16	xxxxxxxx	1's digit		33
17	01001100	", "	Fixed	2C
18	xxxxxxxx	Month 10's digit	July	30
19	xxxxxxxx	1's digit		37
20	01001100	", "	Fixed	2C
21	xxxxxxxx	Year 10's digit	1999	39
22	xxxxxxxx	1's digit		39
23	01001100	", "	Fixed	2C
24	01001100	", "	Fixed	2C
25	00101010	" * "	Fixed	2A
26	xxxxxxxx	Checksum Hexadecimal upper digits	4A	34
27	xxxxxxxx	Hexadecimal lower digits		41
28	00001101	Terminator <CR>	Fixed	0D
29	00001010	<LF>		0A

The Local Zone Description parameter is not output.  
(between No. 23 and No. 24, and between No. 24 and No. 25)

2-1-8. PSNY message (manufacturer expanded output)

No.	BIT 76543210	Contents	Example		
			Setting value	Output data (HEX)	
1	00100100	Header "\$"	Fixed	24	
2	01010000	Address field "P"	Fixed	50	
3	01010011	"S"		53	
4	01011110	"N"		5E	
5	01011001	"Y"		49	
6	01001100	", "		Fixed	2C
7	xxxxxxxx	Preamplifier status "0": Normal "1": Open "2": Shorted	Open	31	
8	01001100	", "	Fixed	2C	
9	xxxxxxxx	Geodesic system "0" to "25"	WGS-84	30	
10	xxxxxxxx			30	
11	01001100	", "	Fixed	2C	
12	xxxxxxxx	Angle of elevation limit (°) 10's digit	5°	30	
13	xxxxxxxx			1's digit	35
14	01001100	", "	Fixed	2C	
15	xxxxxxxx	Speed limit (km/h) 100's digit	500km/h	35	
16	xxxxxxxx			10's digit	30
17	xxxxxxxx			1's digit	30
18	01001100	", "	Fixed	2C	
19	xxxxxxxx	PDOP limit (D-GPS on) 10's digit	4	30	
20	xxxxxxxx			1's digit	34
21	01001100	", "	Fixed	2C	
22	xxxxxxxx	HDOP limit (D-GPS on) 10's digit	6	30	
23	xxxxxxxx			1's digit	36
24	01001100	", "	Fixed	2C	
25	xxxxxxxx	PDOP limit (D-GPS off) 10's digit	4	30	
26	xxxxxxxx			1's digit	34
27	01001100	", "	Fixed	2C	
28	xxxxxxxx	HDOP limit (D-GPS off) 10's digit	6	30	
29	xxxxxxxx			1's digit	36

No.	BIT 76543210	Contents	Example	
			Setting value	Output data (HEX)
30	00101010	" * "	Fixed	2A
31	xxxxxxx	Checksum	4A	34 41
32	xxxxxxx	Hexadecimal upper digits Hexadecimal lower digits		
33	00001101	Terminator <CR>	Fixed	0D 0A
34	00001010	<LF>		

**2-2. Output Timing**

1s period: GPVTG, GPGGA, GPGLL, GPRMC, GPZDA

2s period: GPGSA, PSNY, GPGSV

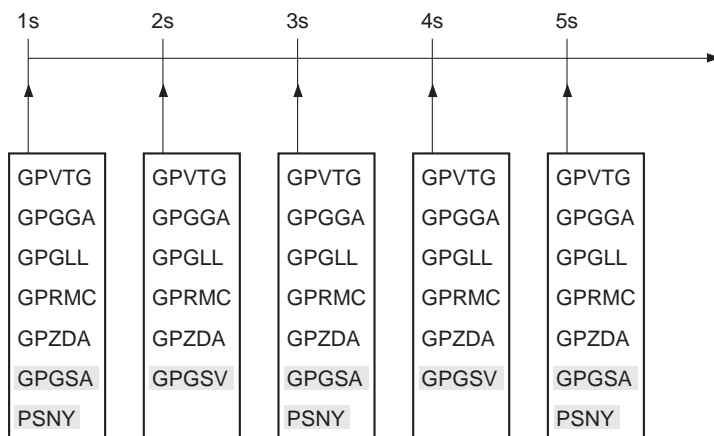



### 3. D-GPS Data Input Specifications

#### 3-1. Communication

##### 3-1-1. Serial input communication method

Interface:	Asynchronous serial interface (UART)
I/O channel:	CH1
Baud rate:	9600bps
Start bit:	1 bit
Data bits:	8 bits
Stop bit:	1 bit
Parity bit:	None
Communication control signal:	None
Input period:	1s or more

##### 3-1-2. Asynchronous serial interface

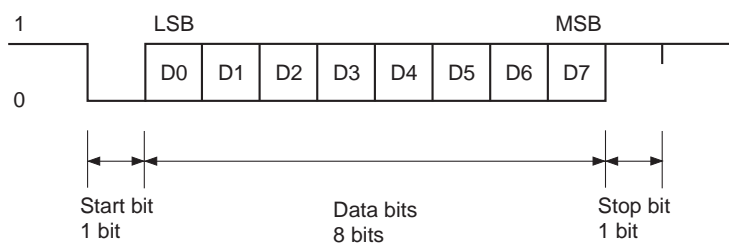

**3-2. RTCM Data Input**

RTCM data input conforms to the RTCM SC-104 format and supports message type 1.

The message type shared header and message type 1 format are shown below. These data are sent in the "6 of 8" format. In this format, each word is divided into 6-bit units, the bits are reordered so that the LSB comes first and the MSB comes last, and then "01" is added to the head of the bits.

**3-2-1. Message type shared header**

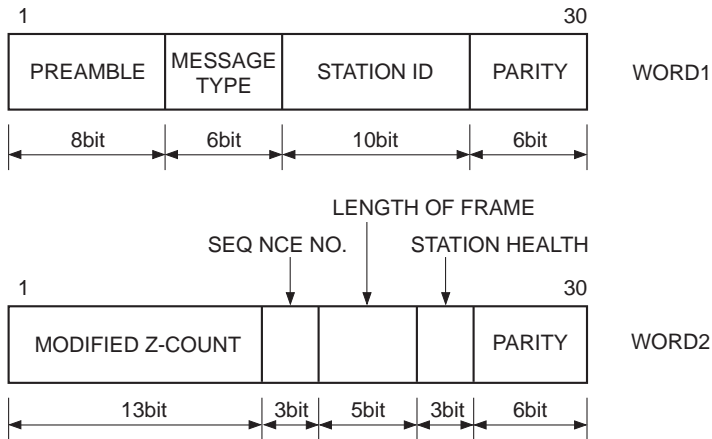

- PREAMBLE: Preamble
- MESSAGE TYPE: Message type
- STATION ID: Reference station ID No.
- PARITY: Error correction code
- MODIFIED Z-COUNT: Modified Z-count
- SEQ NCE NO.: Frame sequence No.
- LENGTH OF FRAME: Frame length
- STATION HEALTH: Reference station health

3-2-2. Message type 1 (differential GPS correction value)

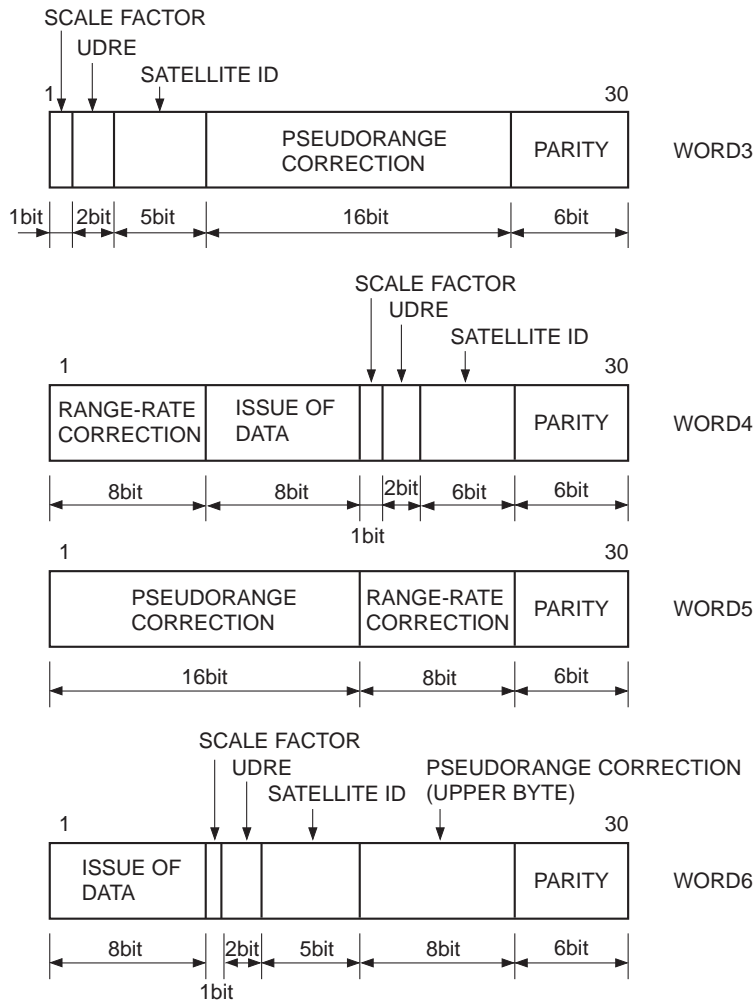

- SCALE FACTOR: Pseudorange correction value scale factor
- UDRE: User differential range error index
- SATELLITE ID: Satellite ID No.
- PSEUDORANGE CORRECTION: Pseudorange correction value
- RANGE-RATE CORRECTION: Pseudorange rate-of-change correction value
- ISSUE OF DATA: Data issue No.



**3-3. DARC Data Input**

DARC data is output in the communication format noted below. The D-GPS basic data is located in the D-GPS segments. The D-GPS basic data is comprised of 288 bits (36 bytes).

Data packet 1 22 bytes		Data packet 2 22 bytes			Checksum 1 byte	Terminator 1 byte
Prefix 4 bytes	D-GPS segment 18 bytes	Prefix 2 bytes	D-GPS segment 18 bytes	CRC 2 bytes	xxh	0Dh

The D-GPS basic data configuration is as follows.

Bit position	Description	Number of bits
1 to 3	D-GPS data ID	3 bits
4	Correction time	1 bit
5 to 38	1st GPS satellite correction data	34 bits
39 to 72	2nd GPS satellite correction data	34 bits
73 to 106	3rd GPS satellite correction data	34 bits
107 to 140	4th GPS satellite correction data	34 bits
141 to 174	5th GPS satellite correction data	34 bits
175 to 208	6th GPS satellite correction data	34 bits
209 to 242	7th GPS satellite correction data	34 bits
243 to 276	8th GPS satellite correction data	34 bits
277 to 288	Communication data	12 bits

The GPS satellite correction data configuration is as follows.

Bit position	Description	Number of bits
1	Scale factor	1 bit
2 to 3	UDRE (User differential range error index)	2 bits
4 to 8	GPS satellite ID	5 bits
9 to 19	PRC (Pseudorange correction value)	11 bits
20 to 26	RRC (Pseudorange rate-of-change correction value)	7 bits
27 to 34	IODE (Ephemeris data issue No.)	8 bits