

DS90CF363

*DS90CF363 +3.3V LVDS Transmitter 18-Bit Flat Panel Display (FPD) Link-65
MHz*



Literature Number: SNLS004

DS90CF363 +3.3V LVDS Transmitter 18-Bit Flat Panel Display (FPD) Link—65 MHz

General Description

The DS90CF363 transmitter converts 21 bits of CMOS/TTL data into three LVDS (Low Voltage Differential Signaling) data streams. A phase-locked transmit clock is transmitted in parallel with the data streams over a fourth LVDS link. Every cycle of the transmit clock 21 bits of input data are sampled and transmitted. At a transmit clock frequency of 65 MHz, 18 bits of RGB data and 3 bits of LCD timing and control data (FPLINE, FPFAME, DRDY) are transmitted at a rate of 455 Mbps per LVDS data channel. Using a 65 MHz clock, the data throughputs is 170 Mbytes/sec.

This chipset is an ideal means to solve EMI and cable size problems associated with wide, high speed TTL interfaces.

Features

- 20 to 65 MHz shift clock support
- Single 3.3V supply
- Chipset (Tx + Rx) power consumption < 250 mW (typ)
- Power-down mode (< 0.5 mW total)
- Single pixel per clock XGA (1024x768) ready
- Supports VGA, SVGA, XGA and higher addressability.
- Up to 170 Megabytes/sec bandwidth
- Up to 1.3 Gbps throughput
- Narrow bus reduces cable size and cost
- 290 mV swing LVDS devices for low EMI
- PLL requires no external components
- Low profile 48-lead TSSOP package
- Falling edge data strobe Transmitter
- Compatible with TIA/EIA-644 LVDS standard
- ESD rating > 7 kV
- Operating Temperature: -40°C to +85°C

Block Diagram

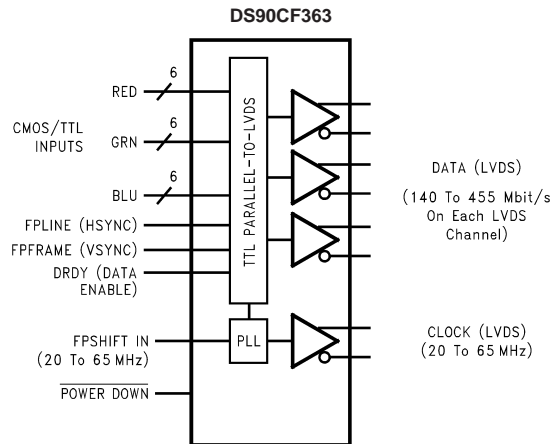

DS100032-1

Order Number DS90CF363MTD
See NS Package Number MTD48

TRI-STATE® is a registered trademark of National Semiconductor Corporation.

Absolute Maximum Ratings (Note 1)

If Military/Aerospace specified devices are required, please contact the National Semiconductor Sales Office/Distributors for availability and specifications.

Supply Voltage (V_{CC})	-0.3V to +4V
CMOS/TTL Input Voltage	-0.3V to ($V_{CC} + 0.3V$)
LVDS Driver Output Voltage	-0.3V to ($V_{CC} + 0.3V$)
LVDS Output Short Circuit Duration	Continuous
Junction Temperature	+150°C
Storage Temperature	-65°C to +150°C
Lead Temperature (Soldering, 4 sec)	+260°C
Maximum Package Power Dissipation Capacity @ 25°C	
MTD48 (TSSOP) Package: DS90CF363	1.98 W

Package Derating: DS90CF363	16 mW/°C above +25°C
ESD Rating (HBM, 1.5 kΩ, 100 pF)	> 7 kV

Recommended Operating Conditions

	Min	Nom	Max	Units
Supply Voltage (V_{CC})	3.0	3.3	3.6	V
Operating Free Air Temperature (T_A)	-40	+25	+85	°C
Receiver Input Range	0		2.4	V
Supply Noise Voltage (V_{CC})			100	mV _{PP}

Electrical Characteristics

Over recommended operating supply and temperature ranges unless otherwise specified.

Symbol	Parameter	Conditions	Min	Typ	Max	Units	
CMOS/TTL DC SPECIFICATIONS							
V_{IH}	High Level Input Voltage		2.0		V_{CC}	V	
V_{IL}	Low Level Input Voltage		GND		0.8	V	
V_{OH}	High Level Output Voltage	$I_{OH} = -0.4$ mA	2.7	3.3		V	
V_{OL}	Low Level Output Voltage	$I_{OL} = 2$ mA		0.1	0.3	V	
V_{CL}	Input Clamp Voltage	$I_{CL} = -18$ mA		-0.79	-1.5	V	
I_{IN}	Input Current	$V_{IN} = V_{CC}$, GND, 2.5V or 0.4V		±5.1	±10	μA	
I_{OS}	Output Short Circuit Current	$V_{OUT} = 0V$		-60	-120	mA	
LVDS DC SPECIFICATIONS							
V_{OD}	Differential Output Voltage	$R_L = 100\Omega$	250	345	450	mV	
ΔV_{OD}	Change in V_{OD} between complimentary output states				35	mV	
V_{OS}	Offset Voltage (Note 4)		1.125	1.25	1.375	V	
ΔV_{OS}	Change in V_{OS} between complimentary output states				35	mV	
I_{OS}	Output Short Circuit Current	$V_{OUT} = 0V$, $R_L = 100\Omega$		-3.5	-5	mA	
I_{OZ}	Output TRI-STATE® Current	Power Down = 0V, $V_{OUT} = 0V$ or V_{CC}		±1	±10	μA	
V_{TH}	Differential Input High Threshold	$V_{CM} = +1.2V$			+100	mV	
V_{TL}	Differential Input Low Threshold		-100			mV	
I_{IN}	Input Current	$V_{IN} = +2.4V$, $V_{CC} = 3.6V$			±10	μA	
		$V_{IN} = 0V$, $V_{CC} = 3.6V$			±10	μA	
TRANSMITTER SUPPLY CURRENT							
ICCTW	Transmitter Supply Current Worst Case	$R_L = 100\Omega$, $C_L = 5$ pF, Worst Case Pattern (Figures 1, 3)	$f = 32.5$ MHz		31	45	mA
			$f = 37.5$ MHz		32	50	mA
			$f = 65$ MHz		42	55	mA
ICCTG	Transmitter Supply Current 16 Grayscale	$R_L = 100\Omega$, $C_L = 5$ pF, 16 Grayscale Pattern (Figures 2, 3)	$f = 32.5$ MHz		23	35	mA
			$f = 37.5$ MHz		28	40	mA
			$f = 65$ MHz		31	45	mA
ICCTZ	Transmitter Supply Current Power Down	Power Down = Low Driver Outputs in TRI-STATE® under Power Down Mode		10	55	μA	

Note 1: "Absolute Maximum Ratings" are those values beyond which the safety of the device cannot be guaranteed. They are not meant to imply that the device should be operated at these limits. The tables of "Electrical Characteristics" specify conditions for device operation.

Electrical Characteristics (Continued)

Note 2: Typical values are given for $V_{CC} = 3.3V$ and $T_A = +25^{\circ}C$.

Note 3: Current into device pins is defined as positive. Current out of device pins is defined as negative. Voltages are referenced to ground unless otherwise specified (except V_{OD} and ΔV_{OD}).

Note 4: V_{OS} previously referred as V_{CM} .

Transmitter Switching Characteristics

Over recommended operating supply and temperature ranges unless otherwise specified

Symbol	Parameter	Min	Typ	Max	Units		
LLHT	LVDS Low-to-High Transition Time (Figure 3)		0.75	1.5	ns		
LHLT	LVDS High-to-Low Transition Time (Figure 3)		0.75	1.5	ns		
TCIT	TxCLK IN Transition Time (Figure 4)			5	ns		
TCCS	TxOUT Channel-to-Channel Skew (Figure 5)		250		ps		
TPPos0	Transmitter Output Pulse Position for Bit 0 (Figure 12)	f = 65 MHz		-0.4	0	0.3	ps
TPPos1	Transmitter Output Pulse Position for Bit 1			1.8	2.2	2.5	ns
TPPos2	Transmitter Output Pulse Position for Bit 2			4.0	4.4	4.7	ns
TPPos3	Transmitter Output Pulse Position for Bit 3			6.2	6.6	6.9	ns
TPPos4	Transmitter Output Pulse Position for Bit 4			8.4	8.8	9.1	ns
TPPos5	Transmitter Output Pulse Position for Bit 5			10.6	11.0	11.3	ns
TPPos6	Transmitter Output Pulse Position for Bit 6			12.8	13.2	13.5	ns
TCIP	TxCLK IN Period (Figure 6)	15	T	50	ns		
TCIH	TxCLK IN High Time (Figure 6)	0.35T	0.5T	0.65T	ns		
TCIL	TxCLK IN Low Time (Figure 6)	0.35T	0.5T	0.65T	ns		
TSTC	TxIN Setup to TxCLK IN (Figure 6)	f = 65 MHz		2.5			ns
THTC	TxIN Hold to TxCLK IN (Figure 6)			0			ns
TCCD	TxCLK IN to TxCLK OUT Delay 25°C, $V_{CC} = 3.3V$ (Figure 7)	3		5.5	ns		
TPLLS	Transmitter Phase Lock Loop Set (Figure 8)			10	ms		
TPDD	Transmitter Power Down Delay (Figure 11)			100	ns		

AC Timing Diagrams

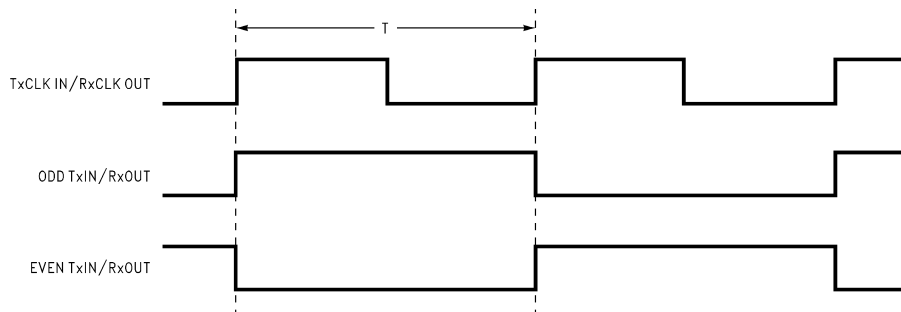

DS100032-4

FIGURE 1. "Worst Case" Test Pattern

AC Timing Diagrams (Continued)

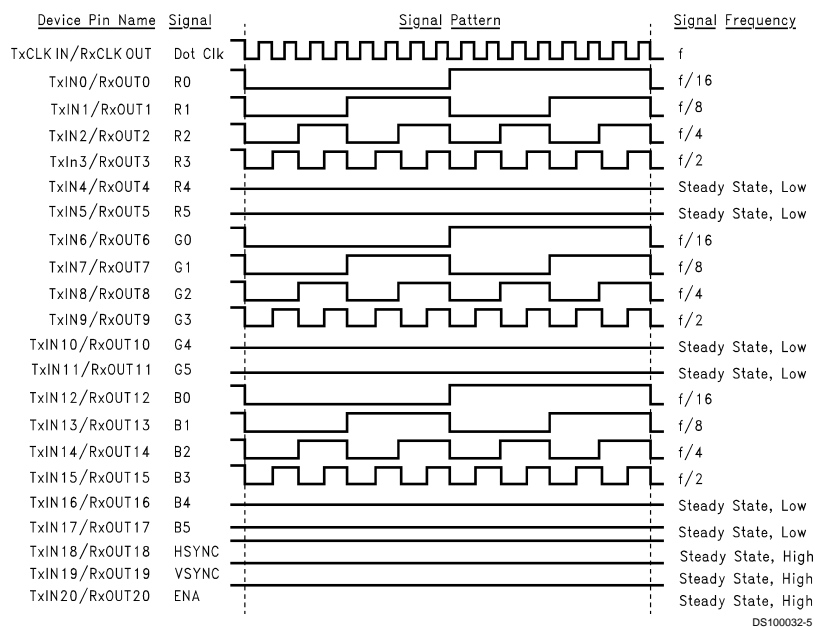

FIGURE 2. "16 Grayscale" Test Pattern (Notes 5, 6, 7, 8)

Note 5: The worst case test pattern produces a maximum toggling of digital circuits, LVDS I/O and CMOS/TTL I/O.

Note 6: The 16 grayscale test pattern tests device power consumption for a "typical" LCD display pattern. The test pattern approximates signal switching needed to produce groups of 16 vertical stripes across the display.

Note 7: Figures 1, 2 show a falling edge data strobe (TxCLK IN/RxCLK OUT).

Note 8: Recommended pin to signal mapping. Customer may choose to define differently.

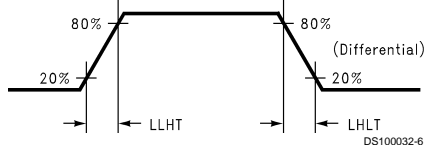

FIGURE 3. DS90CF363 (Transmitter) LVDS Output Load and Transition Times

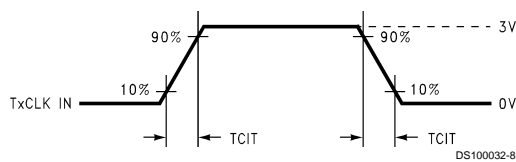
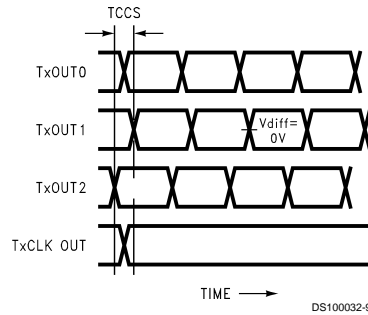

FIGURE 4. DS90CF363 (Transmitter) Input Clock Transition Time

AC Timing Diagrams (Continued)



Measurements at $V_{diff} = 0V$
 TCCS measured between earliest and latest LVDS edges
 TxCLK Differential Low → High Edge

FIGURE 5. DS90CF363 (Transmitter) Channel-to-Channel Skew

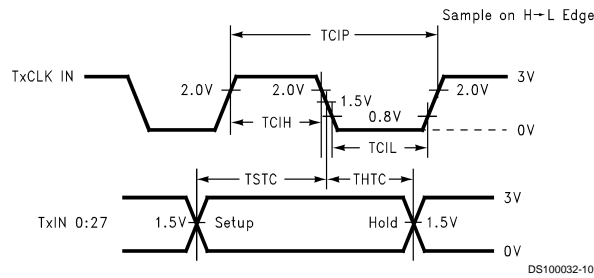

FIGURE 6. DS90CF363 (Transmitter) Setup/Hold and High/Low Times

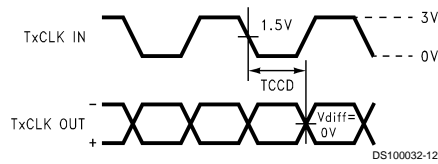

FIGURE 7. DS90CF363 (Transmitter) Clock In to Clock Out Delay

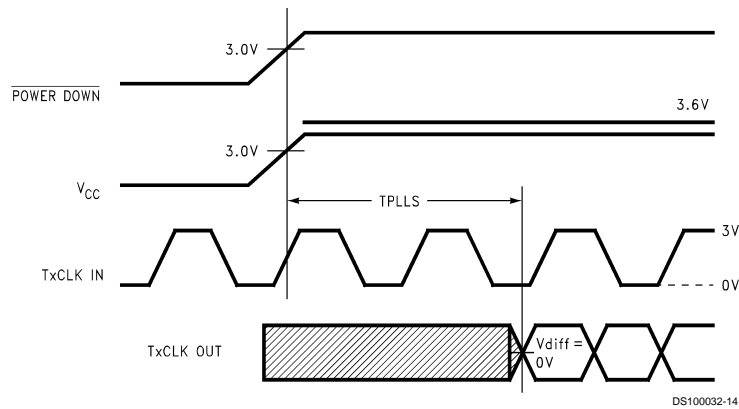

FIGURE 8. DS90CF363 (Transmitter) Phase Lock Loop Set Time

AC Timing Diagrams (Continued)

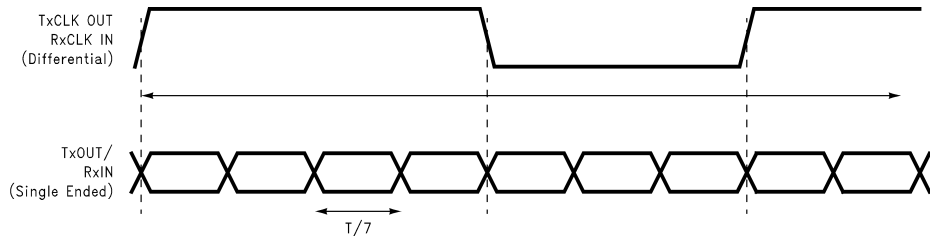

FIGURE 9. Seven Bits of LVDS in One Clock Cycle

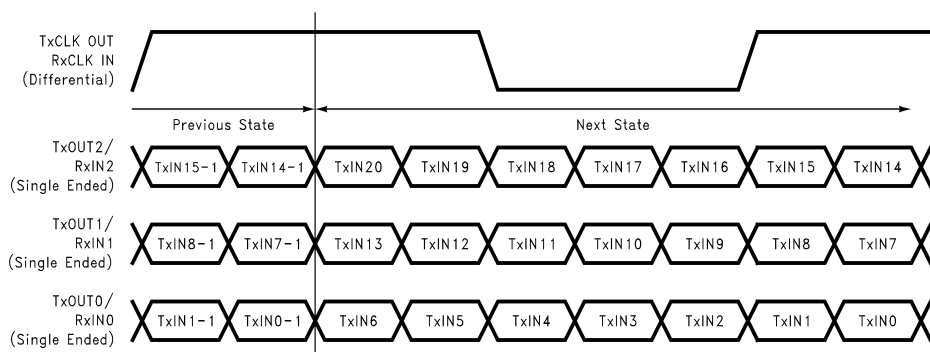

FIGURE 10. 21 Parallel TTL Data Inputs Mapped to LVDS Outputs

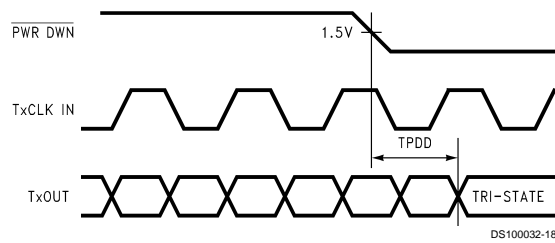
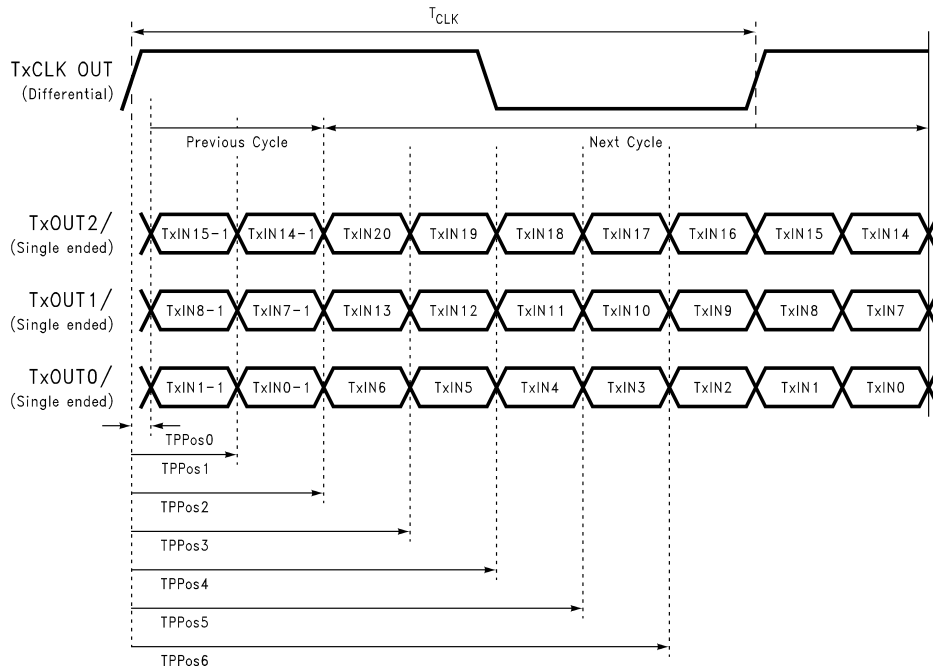

FIGURE 11. Transmitter Power Down Delay

AC Timing Diagrams (Continued)



DS100032-20

FIGURE 12. Transmitter LVDS Output Pulse Position Measurement

DS90CF363 Pin Description—FPD Link Transmitter

Pin Name	I/O	No.	Description
TxIN	I	21	TTL level input. This includes: 6 Red, 6 Green, 6 Blue, and 3 control lines — FPLINE, FPFrames and DRDY (also referred to as HSYNC, VSYNC, Data Enable).
TxOUT+	O	3	Positive LVDS differential data output.
TxOUT-	O	3	Negative LVDS differential data output.
FPSHIFT IN	I	1	TTL level clock input. The falling edge acts as data strobe. Pin name TxCLK IN.
TxCLK OUT+	O	1	Positive LVDS differential clock output.
TxCLK OUT-	O	1	Negative LVDS differential clock output.
PWR DOWN	I	1	TTL level input. When asserted (low input) TRI-STATES the outputs, ensuring low current at power down.
V _{CC}	I	4	Power supply pins for TTL inputs.
GND	I	4	Ground pins for TTL inputs.
PLL V _{CC}	I	1	Power supply pin for PLL.
PLL GND	I	2	Ground pins for PLL.
LVDS V _{CC}	I	1	Power supply pin for LVDS outputs.
LVDS GND	I	3	Ground pins for LVDS outputs.

Applications Information

The DS90CF363 and DS90CF364 are backward compatible with the existing 5V FPD Link transmitter/receiver pair (DS90CF563 and DS90CF564). To upgrade from a 5V to a 3.3V system the following must be addressed:

1. Change 5V power supply to 3.3V. Provide this supply to the V_{CC}, LVDS V_{CC} and PLL V_{CC} of both the transmitter

and receiver devices. This change may enable the removal of a 5V supply from the system, and power may be supplied from an existing 3V power source.

2. The DS90CF363 transmitter input and control inputs accept 3.3V TTL/CMOS levels. They are not 5V tolerant.

Pin Diagram

DS90CF363

TxIN4	1	48	TxIN3
V _{CC}	2	47	TxIN2
TxIN5	3	46	GND
TxIN6	4	45	TxIN1
GND	5	44	TxIN0
TxIN7	6	43	N/C
TxIN8	7	42	LVDS GND
V _{CC}	8	41	TxOUT0-
TxIN9	9	40	TxOUT0+
TxIN10	10	39	TxOUT1-
GND	11	38	TxOUT1+
TxIN11	12	37	LVDS V _{CC}
TxIN12	13	36	LVDS GND
V _{CC}	14	35	TxOUT2-
TxIN13	15	34	TxOUT2+
TxIN14	16	33	TxCLK OUT-
GND	17	32	TxCLK OUT+
TxIN15	18	31	LVDS GND
TxIN16	19	30	PLL GND
TxIN17	20	29	PLL V _{CC}
V _{CC}	21	28	PLL GND
TxIN18	22	27	PWR DWN
TxIN19	23	26	TxCLK IN
GND	24	25	TxIN20

DS100032-23

Application

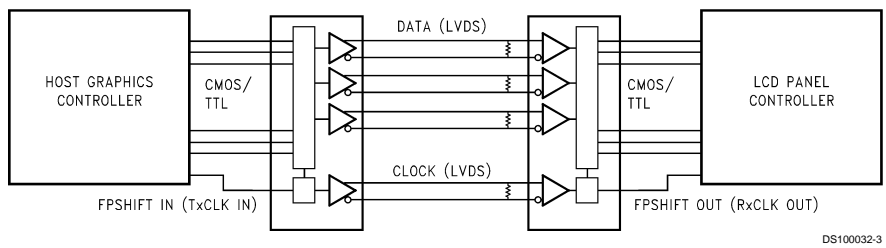

Physical Dimensions inches (millimeters) unless otherwise noted

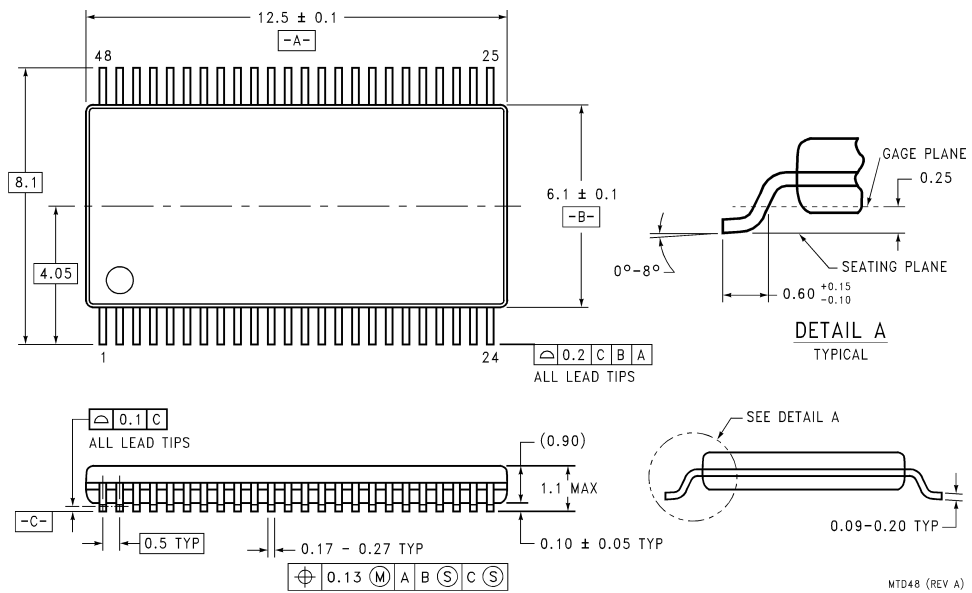

48-Lead Molded Thin Shrink Small Outline Package, JEDEC
Order Number DS90CF363MTD
NS Package Number MTD48

LIFE SUPPORT POLICY

NATIONAL'S PRODUCTS ARE NOT AUTHORIZED FOR USE AS CRITICAL COMPONENTS IN LIFE SUPPORT DEVICES OR SYSTEMS WITHOUT THE EXPRESS WRITTEN APPROVAL OF THE PRESIDENT AND GENERAL COUNSEL OF NATIONAL SEMICONDUCTOR CORPORATION. As used herein:

1. Life support devices or systems are devices or systems which, (a) are intended for surgical implant into the body, or (b) support or sustain life, and whose failure to perform when properly used in accordance with instructions for use provided in the labeling, can be reasonably expected to result in a significant injury to the user.
2. A critical component is any component of a life support device or system whose failure to perform can be reasonably expected to cause the failure of the life support device or system, or to affect its safety or effectiveness.

National Semiconductor Corporation
 Americas
 Tel: 1-800-272-9959
 Fax: 1-800-737-7018
 Email: support@nsc.com
 www.national.com

National Semiconductor Europe
 Fax: +49 (0) 1 80-530 85 86
 Email: europe.support@nsc.com
 Deutsch Tel: +49 (0) 1 80-530 85 85
 English Tel: +49 (0) 1 80-532 78 32
 Français Tel: +49 (0) 1 80-532 93 58
 Italiano Tel: +49 (0) 1 80-534 16 80

National Semiconductor Asia Pacific Customer Response Group
 Tel: 65-2544466
 Fax: 65-2504466
 Email: sea.support@nsc.com

National Semiconductor Japan Ltd.
 Tel: 81-3-5639-7560
 Fax: 81-3-5639-7507

IMPORTANT NOTICE

Texas Instruments Incorporated and its subsidiaries (TI) reserve the right to make corrections, modifications, enhancements, improvements, and other changes to its products and services at any time and to discontinue any product or service without notice. Customers should obtain the latest relevant information before placing orders and should verify that such information is current and complete. All products are sold subject to TI's terms and conditions of sale supplied at the time of order acknowledgment.

TI warrants performance of its hardware products to the specifications applicable at the time of sale in accordance with TI's standard warranty. Testing and other quality control techniques are used to the extent TI deems necessary to support this warranty. Except where mandated by government requirements, testing of all parameters of each product is not necessarily performed.

TI assumes no liability for applications assistance or customer product design. Customers are responsible for their products and applications using TI components. To minimize the risks associated with customer products and applications, customers should provide adequate design and operating safeguards.

TI does not warrant or represent that any license, either express or implied, is granted under any TI patent right, copyright, mask work right, or other TI intellectual property right relating to any combination, machine, or process in which TI products or services are used. Information published by TI regarding third-party products or services does not constitute a license from TI to use such products or services or a warranty or endorsement thereof. Use of such information may require a license from a third party under the patents or other intellectual property of the third party, or a license from TI under the patents or other intellectual property of TI.

Reproduction of TI information in TI data books or data sheets is permissible only if reproduction is without alteration and is accompanied by all associated warranties, conditions, limitations, and notices. Reproduction of this information with alteration is an unfair and deceptive business practice. TI is not responsible or liable for such altered documentation. Information of third parties may be subject to additional restrictions.

Resale of TI products or services with statements different from or beyond the parameters stated by TI for that product or service voids all express and any implied warranties for the associated TI product or service and is an unfair and deceptive business practice. TI is not responsible or liable for any such statements.

TI products are not authorized for use in safety-critical applications (such as life support) where a failure of the TI product would reasonably be expected to cause severe personal injury or death, unless officers of the parties have executed an agreement specifically governing such use. Buyers represent that they have all necessary expertise in the safety and regulatory ramifications of their applications, and acknowledge and agree that they are solely responsible for all legal, regulatory and safety-related requirements concerning their products and any use of TI products in such safety-critical applications, notwithstanding any applications-related information or support that may be provided by TI. Further, Buyers must fully indemnify TI and its representatives against any damages arising out of the use of TI products in such safety-critical applications.

TI products are neither designed nor intended for use in military/aerospace applications or environments unless the TI products are specifically designated by TI as military-grade or "enhanced plastic." Only products designated by TI as military-grade meet military specifications. Buyers acknowledge and agree that any such use of TI products which TI has not designated as military-grade is solely at the Buyer's risk, and that they are solely responsible for compliance with all legal and regulatory requirements in connection with such use.

TI products are neither designed nor intended for use in automotive applications or environments unless the specific TI products are designated by TI as compliant with ISO/TS 16949 requirements. Buyers acknowledge and agree that, if they use any non-designated products in automotive applications, TI will not be responsible for any failure to meet such requirements.

Following are URLs where you can obtain information on other Texas Instruments products and application solutions:

Products

Audio	www.ti.com/audio
Amplifiers	amplifier.ti.com
Data Converters	dataconverter.ti.com
DLP® Products	www.dlp.com
DSP	dsp.ti.com
Clocks and Timers	www.ti.com/clocks
Interface	interface.ti.com
Logic	logic.ti.com
Power Mgmt	power.ti.com
Microcontrollers	microcontroller.ti.com
RFID	www.ti-rfid.com
OMAP Mobile Processors	www.ti.com/omap
Wireless Connectivity	www.ti.com/wirelessconnectivity

Applications

Communications and Telecom	www.ti.com/communications
Computers and Peripherals	www.ti.com/computers
Consumer Electronics	www.ti.com/consumer-apps
Energy and Lighting	www.ti.com/energy
Industrial	www.ti.com/industrial
Medical	www.ti.com/medical
Security	www.ti.com/security
Space, Avionics and Defense	www.ti.com/space-avionics-defense
Transportation and Automotive	www.ti.com/automotive
Video and Imaging	www.ti.com/video

TI E2E Community Home Page

e2e.ti.com

Mailing Address: Texas Instruments, Post Office Box 655303, Dallas, Texas 75265
Copyright © 2011, Texas Instruments Incorporated