

# Quad exclusive OR gate

**BU4030B/BU4030BF**

**BU4070B/BU4070BF**

The BU4030B/F and BU4070B/F are exclusive OR gates.

Four circuits are contained on a single chip. An inverter-based buffer is added to the gate output for an enhanced I/O voltage characteristic, and the load capacitance has been increased to minimize fluctuation in the propagation time.

In addition, these products feature low power consumption and a high noise margin. These can also be used in digital comparators and parity circuit applications.

●Features

- 1) Low power consumption.
- 2) Wide range of operating power supply voltages.
- 3) High input impedance.
- 4) High fan-out.
- 5) Direct drive of 2 L-TTL inputs and 1 LS-TTL input.

●Truth table

INPUT		OUTPUT
A	B	
L	L	L
L	H	H
H	L	H
H	H	L

●Block diagram

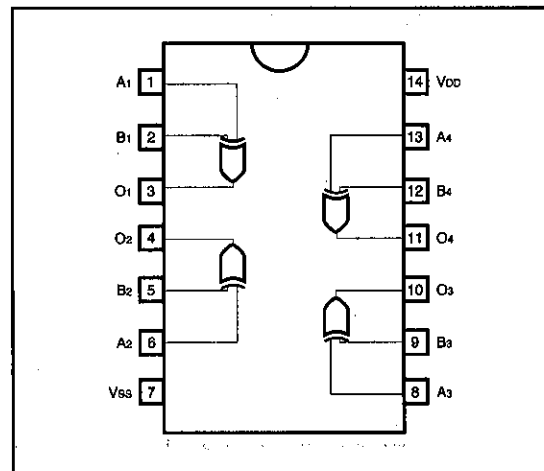

●Absolute maximum ratings (Ta=25°C)

Parameter	Symbol	Limits	Unit
Power supply voltage	V <sub>DD</sub>	-0.3~18	V
Power dissipation	P <sub>d</sub>	1000 (DIP) , 450 (SOP)	mW
Operating temperature	T <sub>opr</sub>	-40~85	°C
Storage temperature	T <sub>stg</sub>	-55~150	°C
Input voltage	V <sub>IN</sub>	-0.3~V <sub>DD</sub> +0.3	V

## ●Electrical characteristics

DC characteristics (unless otherwise noted, Ta=25°C)

Parameter	Symbol	Min.	Typ.	Max.	Unit	V <sub>DD</sub> (V)	Conditions	Measurement Circuit
"H" input voltage	V <sub>IH</sub>	3.5	—	—	V	5	—	Fig.1
		7.0	—	—		10		
		11.0	—	—		15		
"L" input voltage	V <sub>IL</sub>	—	—	1.5	V	5	—	Fig.1
		—	—	3.0		10		
		—	—	4.0		15		
"H" input current	I <sub>IH</sub>	—	—	0.3	μA	15	V <sub>IH</sub> =15V	Fig.1
"L" input current	I <sub>IL</sub>	—	—	-0.3	μA	15	V <sub>IL</sub> =0V	Fig.1
"H" output voltage	V <sub>OH</sub>	4.95	—	—	V	5	I <sub>o</sub> =0mA	Fig.1
		9.95	—	—		10		
		14.95	—	—		15		
"L" output voltage	V <sub>OL</sub>	—	—	0.05	V	5	I <sub>o</sub> =0mA	Fig.1
		—	—	0.05		10		
		—	—	0.05		15		
"H" output current	I <sub>OH</sub>	-0.16	—	—	mA	5	V <sub>OH</sub> =4.6V	Fig.1
		-0.4	—	—		10	V <sub>OH</sub> =9.5V	
		-1.2	—	—		15	V <sub>OH</sub> =13.5V	
"L" output current	I <sub>OL</sub>	0.44	—	—	mA	5	V <sub>OL</sub> =0.4V	Fig.1
		1.1	—	—		10	V <sub>OL</sub> =0.5V	
		3.0	—	—		15	V <sub>OL</sub> =1.5V	
Quiescent supply current	I <sub>DD</sub>	—	—	1	μA	5	V <sub>I</sub> =V <sub>DD</sub> or GND	—
		—	—	2		10		
		—	—	4		15		

BU4000B series

CMOS logic

Switching characteristics (unless otherwise noted,  $T_a=25^{\circ}\text{C}$ ,  $C_L=50\text{pF}$ )

Parameter	Symbol	Min.	Typ.	Max.	Unit.	V <sub>DD</sub> (V)	Conditions	Measurement Circuit
						5		
Output rise time	t <sub>rLH</sub>	—	180	—	ns	5	—	Fig.2
		—	90	—		10		
		—	65	—		15		
Output fall time	t <sub>rHL</sub>	—	100	—	ns	5	—	Fig.2
		—	50	—		10		
		—	40	—		15		
"L" to "H" propagation delay time	t <sub>pLH</sub>	—	175	—	ns	5	—	Fig.2
		—	75	—		10		
		—	50	—		15		
"H" to "L" propagation delay time	t <sub>pHL</sub>	—	175	—	ns	5	—	Fig.2
		—	75	—		10		
		—	50	—		15		
Input capacitance	C <sub>i</sub>	—	5	—	pF	—	—	—

● Measurement circuits

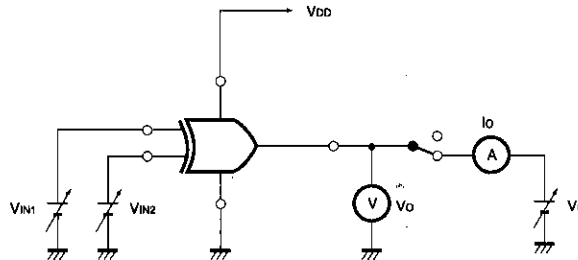

Fig. 1 DC characteristics measurement circuit

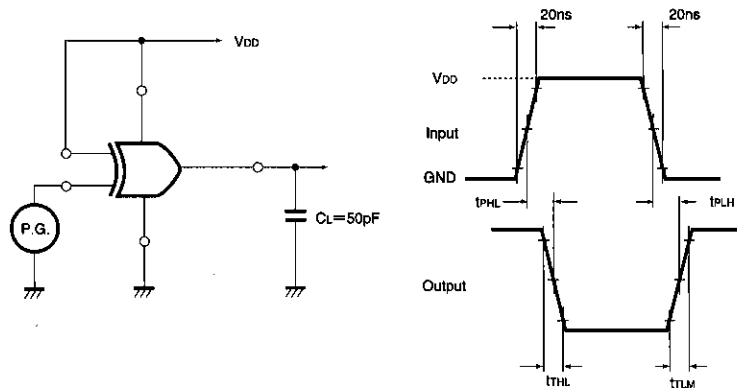

Fig. 2 Switching characteristics measurement circuit

● Electrical characteristic curve

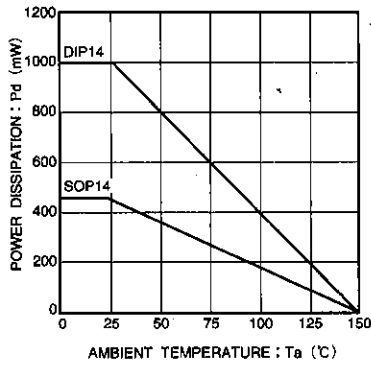
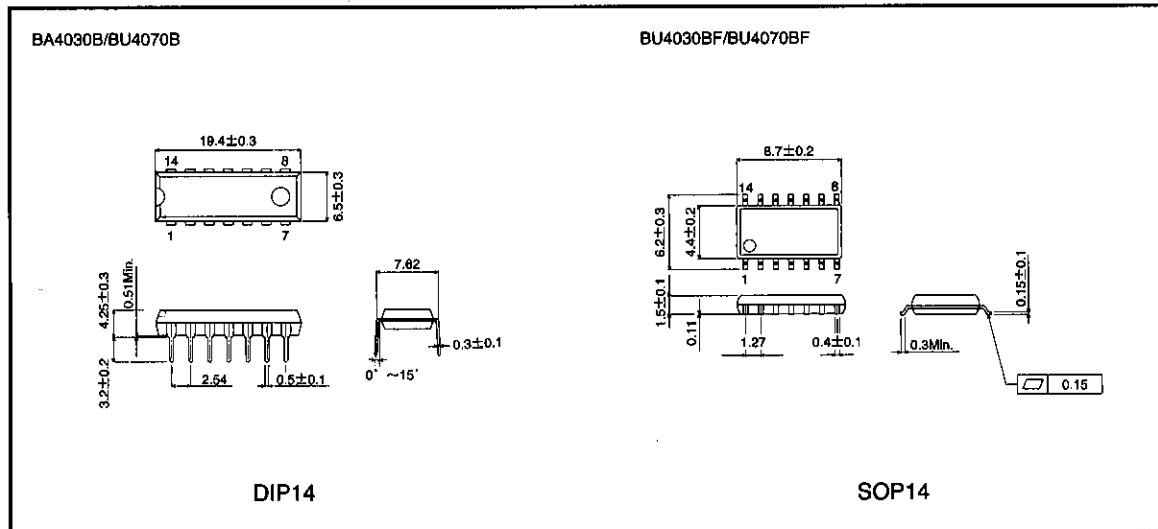

Fig.3 Power dissipation - Ta characteristic

● External dimensions (Units: mm)



BU4000B series

CMOS logic

# Series Standard

## BU4000B

The BU4000 Series are CMOS ICs featuring low voltage and low power consumption. The wide range of operating power supply voltages is compatible with the general-purpose 4000B Series, and when a 5V power supply voltage is used, the LS-TTL IC can be driven directly.

These ICs are available in SOP and SSOP packages as well as the standard DIP package.

●Features

- 1) Low power consumption.
- 2) Wide range of operating power supply voltages.
- 3) High input impedance.
- 4) High fan-out.
- 5) Direct drive of 2 L-TTL inputs and 1 LS-TTL input.

●Absolute maximum ratings (Ta = 25°C)

Parameter	Symbol	Limits	Unit
Power supply voltage	V <sub>DD</sub>	18 *1	V
Input voltage	V <sub>IN</sub>	-0.3~V <sub>DD</sub> +0.3	V
Power dissipation *2	P <sub>d</sub>	Please refer to specifications for individual package	mW
Storage temperature	T <sub>stg</sub>	-55~150	°C

\*1 For the BU4XXXBC type, V<sub>DD</sub> = 20 V.

\*2 The values for the SOP and SSOP packages are the values when mounted on a glass epoxy PCB (50 mm x 50 mm x 1.6 mm).

●Recommended operating conditions (Ta = 25°C)

Parameter	Symbol	Limits	Unit
Power supply voltage	V <sub>DD</sub>	3~16 *	V
Input voltage	V <sub>IN</sub>	0~V <sub>DD</sub>	V
Operating temperature	T <sub>opr</sub>	-40~85	°C

\* For the BU4XXXBC type, V<sub>DD</sub> = 3 to 18 V.

●Electrical characteristic curves

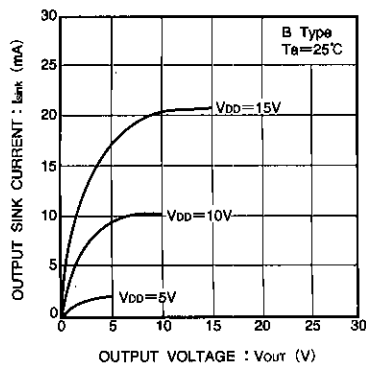

Fig.1 Output sink current - output voltage characteristic

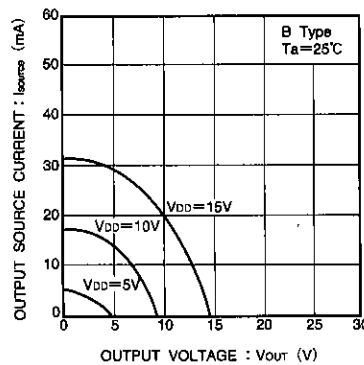

Fig.2 Output source current - output voltage characteristic

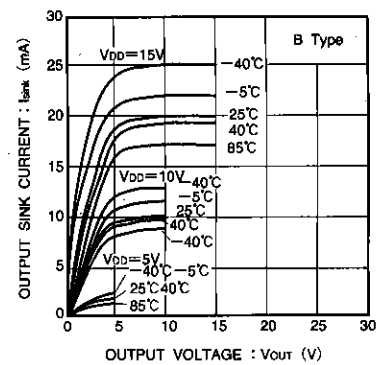

Fig.3 Output SINK current - output voltage characteristic

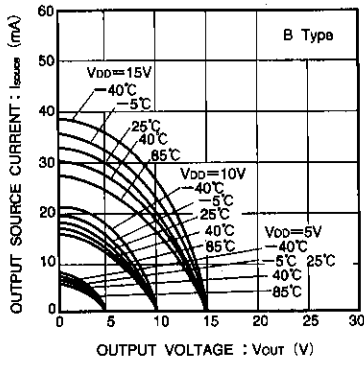

Fig.4 Output source current - output voltage characteristic

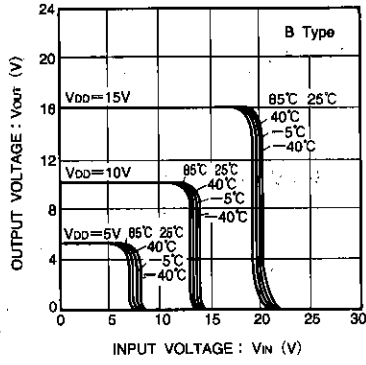

Fig.5 Output voltage - input voltage characteristic

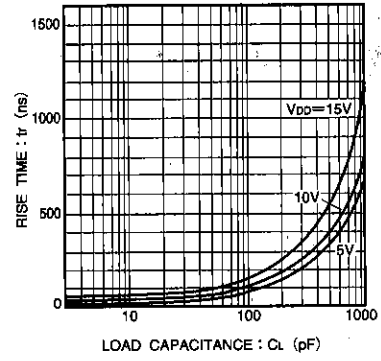

Fig.6 Rise time - load capacitance characteristic

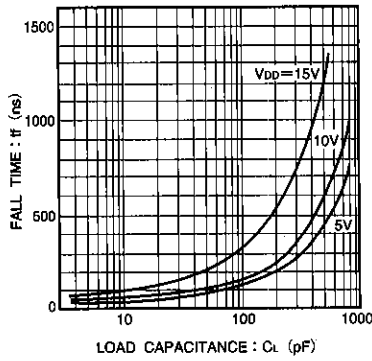

Fig.7 Fall time - load capacitance characteristic

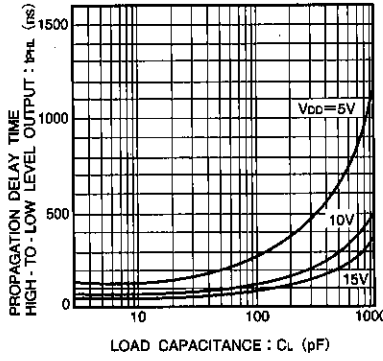

Fig.8 "H" to "L" propagation delay time - load capacitance characteristic

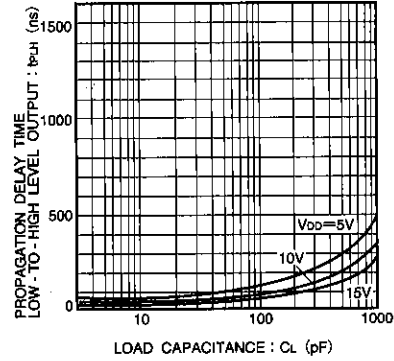

Fig.9 "L" to "H" propagation delay time - load capacitance characteristic

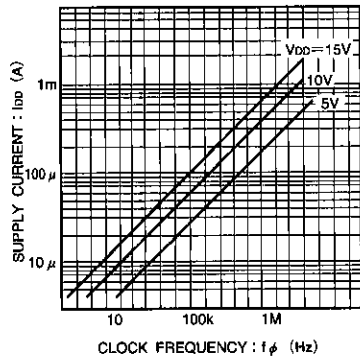

Fig.10 Supply current - clock frequency characteristic

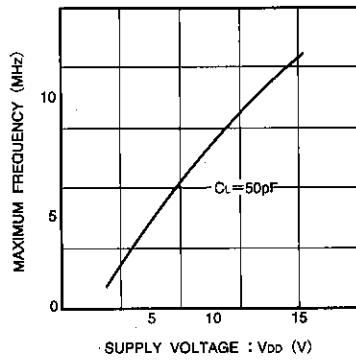

Fig.11 Maximum clock frequency - power supply voltage characteristic

## Notes

- The contents described in this catalogue are correct as of March 1997.
- No unauthorized transmission or reproduction of this book, either in whole or in part, is permitted.
- The contents of this book are subject to change without notice. Always verify before use that the contents are the latest specifications. If, by any chance, a defect should arise in the equipment as a result of use without verification of the specifications, ROHM CO., LTD., can bear no responsibility whatsoever.
- Application circuit diagrams and circuit constants contained in this data book are shown as examples of standard use and operation. When designing for mass production, please pay careful attention to peripheral conditions.
- Any and all data, including, but not limited to application circuit diagrams, information, and various data, described in this catalogue are intended only as illustrations of such devices and not as the specifications for such devices. ROHM CO., LTD., disclaims any warranty that any use of such device shall be free from infringement of any third party's intellectual property rights or other proprietary rights, and further, assumes absolutely no liability in the event of any such infringement, or arising from or connected with or related to the use of such devices.
- Upon the sale of any such devices; other than for the buyer's right to use such devices itself, resell or otherwise dispose of the same; no express or implied right or license to practice or commercially exploit any intellectual property rights or other proprietary rights owned or controlled by ROHM CO., LTD., is granted to any such buyer.
- The products in this manual are manufactured with silicon as the main material.
- The products in this manual are not of radiation resistant design.

The products listed in this catalogue are designed to be used with ordinary electronic equipment or devices (such as audio-visual equipment, office-automation equipment, communications devices, electrical appliances, and electronic toys). Should you intend to use these products with equipment or devices which require an extremely high level of reliability and the malfunction of which would directly endanger human life (such as medical instruments, transportation equipment, aerospace machinery, nuclear-reactor controllers, fuel controllers, or other safety devices) please be sure to consult with our sales representatives in advance.

- Notes when exporting
  - It is essential to obtain export permission when exporting any of the above products when it falls under the category of strategic material (or labor) as determined by foreign exchange or foreign trade control laws.
  - Please be sure to consult with our sales representatives to ascertain whether any product is classified as a strategic material.