

# AN6164K, AN6164S

## Constant Voltage Drive Speech Network Circuits

### Overview

The AN6164K and AN6164S are ICs for constant voltage drive type speech networks.

They incorporate a speaker amplifier and attenuator and suitable for the car telephone and business telephone.

### Features

- Capable of interfacing with the piezo-electric receivers and dynamic receivers
- Capable of interfacing with the piezo-electric transmitters and ECM type transmitters
- Balance input for both receiver and transmitter system in order to prevent mixture of humming noises
- Capable of muting each amplifier by external control
- Built-in attenuator circuit in the receiver system to allow 7-step adjustment of attenuation (0 to -30dB) with the switch 3 terminals
- Built-in standby circuit for the power supply to allow low power consumption ; supply current of 15  $\mu$ A or less in the standby mode

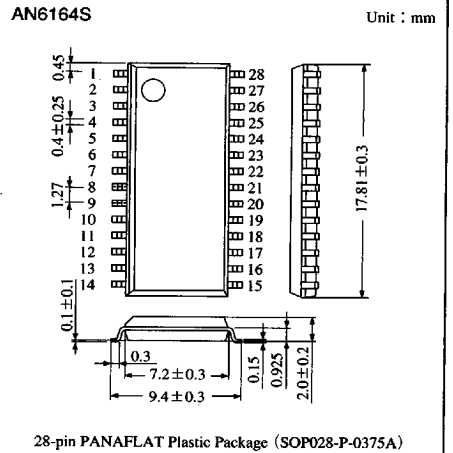
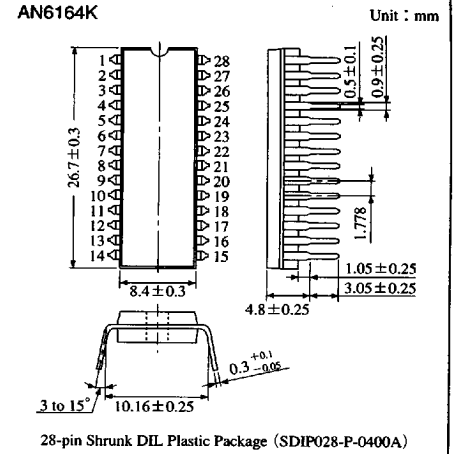

### Block Diagram

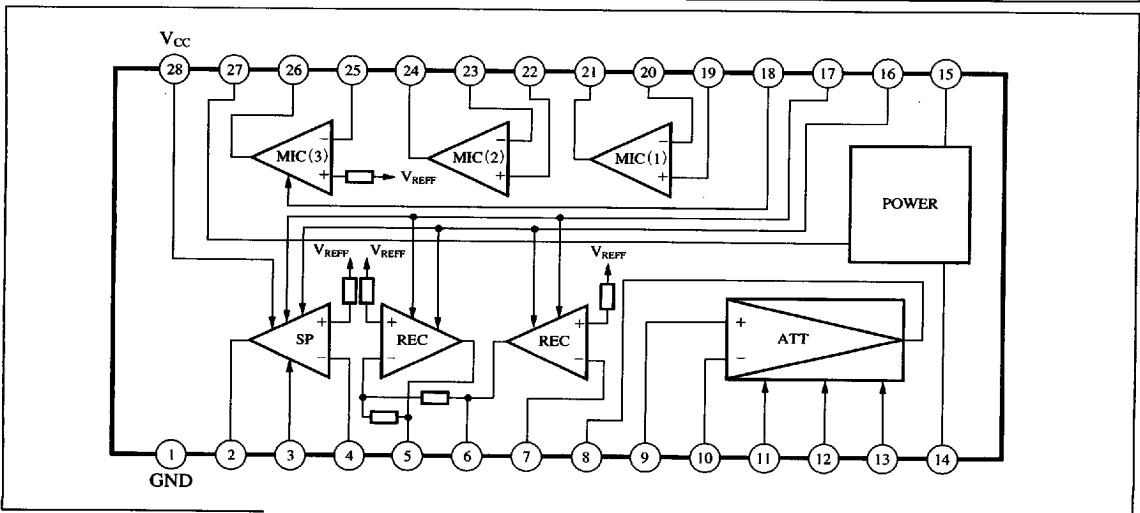

6932852 0013063 78T

### ■ Absolute Maximum Ratings (Ta=25°C)

Parameter	Symbol	Rating	Unit
Supply voltage	V <sub>CC</sub>	-0.3 to +14.4	V
Supply current	I <sub>CC</sub>	1	A
Power dissipation	P <sub>D</sub>	380*	mW
Operating ambient temperature	T <sub>opr</sub>	-20 to +75	°C
Storage temperature	T <sub>stg</sub>	-55 to +125	°C

\* Operating ambient temperature Ta=75°C, mounted onto the glass epoxy PCB (50×50×1.2mm)

### ■ Recommended Operating Range (Ta=25°C)

Parameter	Symbol	Range
Operating supply voltage range	V <sub>CC</sub>	4.5 to 8V

### ■ Electrical Characteristics (V<sub>CC</sub>=5V, f=1kHz, Ta=25°C)

Parameter	Symbol	Condition	min	typ	max	Unit
Current consumption (SP MODE)	I <sub>CC</sub> (SP)	Measure current consumption at V <sub>CC</sub> =8V and at the speaker mode.	5	11	17	mA
Current consumption (STANDBY MODE)	I <sub>st</sub>	Measure current consumption at V <sub>CC</sub> =8V and at the standby mode.	—	—	15	μA
Microphone amplifier (1) open circuit gain	G <sub>v</sub> (M1)	Input a signal to the Pin⑩ and measure the open circuit gain at the Pin②.	55	—	—	dB
Microphone amplifier (1) output level	V <sub>O</sub> (M1)	Measure a distortion factor at the Pin② at gain=20 dB, load=600Ω, and output=-2dB.	—	—	5	%
Microphone amplifier (1) noise output voltage	V <sub>no</sub> (M1)	Measure the noise level with DIN/AUDIO at R <sub>g</sub> =2.2kΩ and gain=20 dB.	—	-90	-80	dBV
Receiver amplifier gain	G <sub>v</sub> (REC)	Set the gain to 20 dB with an external resistor and measure the gain at V <sub>in</sub> =-25 dBV.	18	20	22	dB
Receiver amplifier output level	V <sub>O</sub> (REC)	Measure a distortion factor at gain=20 dB, load=100Ω, and output=0 dBV.	—	—	5	%
Receiver amplifier noise output voltage	V <sub>no</sub> (REC)	Measure the noise level with DIN/AUDIO at R <sub>g</sub> =2.2kΩ and gain=20 dB.	—	-80	-70	dB
ΔATT (1)	ΔATT (1)	Input a signal (-10 dBV) to the Pin⑨ and measure the output level. Ground the Pin①.	-7	-5	-3	dB
ΔATT (2)	ΔATT (2)	Input a signal (-10 dBV) to the Pin⑨ and measure the output level. Ground the Pin②.	-12	-10	-8	dB
ΔATT (3)	ΔATT (3)	Input a signal (-10 dBV) to the Pin⑨ and measure the output level. Ground the Pin③.	-17	-15	-13	dB
ATT	ATT	Input a signal (-10 dBV) to the Pin⑨ and measure the output level.	-2	0	+2	dB
Speaker amplifier open circuit gain	G <sub>v</sub> (SP)	Input a signal to the Pin④ and measure the open circuit gain of the Pin②.	40	—	—	dB
Speaker amplifier output level	V <sub>O</sub> (SP)	Measure a distortion factor at the Pin② at gain=26 dB, load=16Ω, and output=0 dBV.	—	—	5	%
Speaker amplifier noise output voltage	V <sub>no</sub> (SP)	Measure the noise level with DIN/AUDIO at R <sub>g</sub> =2.2kΩ and gain=26 dB.	—	-85	-75	dBV
Control voltage (H)	V (H)		2	—	V <sub>CC</sub> +0.3	V
Control voltage (L)	V (L)		-0.3	—	+0.5	V
Control pin suction current	I <sub>cont</sub>	Measure a current flowing out when the control pin is ground.	—	—	20	μA

6932852 0013064 616

Panasonic

ICs for Telephone

■ Application Circuit

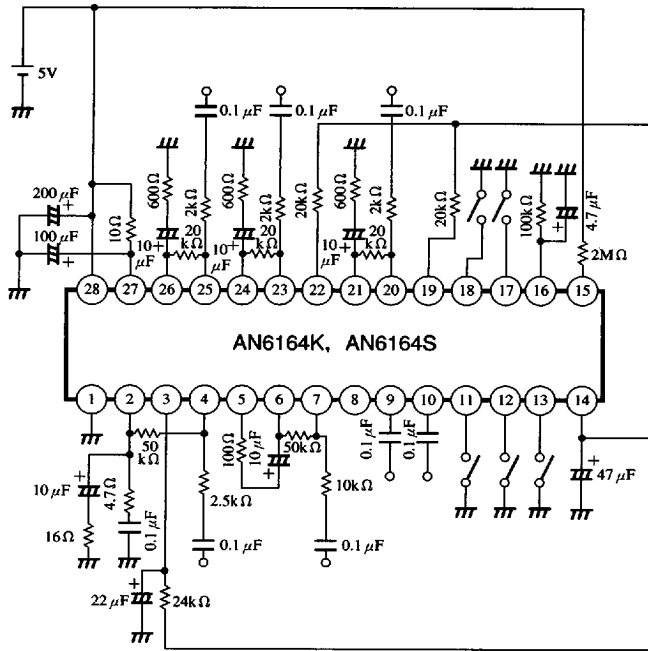







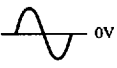
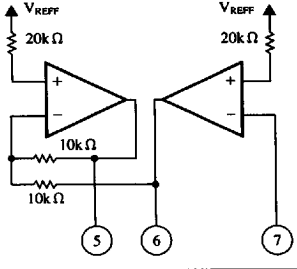
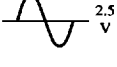
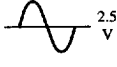
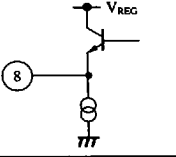
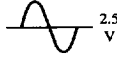
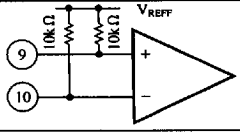

■ Pin Descriptions

Pin No.	Pin name	Typical waveform	Description	Equivalent circuit
1	GND	DC 0V	Ground pin. Connect to the ground potential.	
2	SP output		Speaker output pin. Outputs a receives signal to the speaker.	
3	SP cont	W/o external capacitor: W/ external capacitor:	Speaker control pin. Connect to GND through the 22 μF electrolytic capacitor.	
4	SP input		Speaker signal input pin. Inputs a speaker signal through the coupling capacitor.	

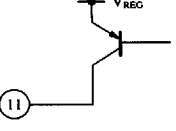
6932852 0013065 552

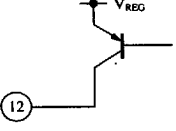
Panasonic

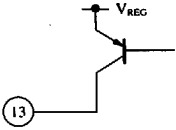
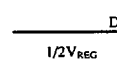
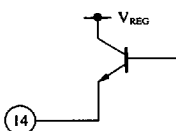
### Pin Descriptions (cont.)

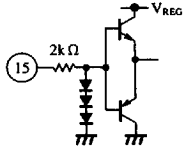
Pin No.	Pin name	Typical waveform	Description	Equivalent circuit
5	RO-2		Receiver output pins 2 and 1. Connects to the receiver through the coupling capacitor. The receiver connected is a 100Ω dynamic type or 1 kΩ piezo-electric type.	
6	RO-1			
7	REC input		Receiver input pin. Inputs a receiver signal through the coupling capacitor.	
8	ATT output		Attenuator output pin. Connects to the receiver amplifier and speaker amplifier through the coupling capacitor.	
9	ATT (+) input		Attenuator positive input pin and negative input pin. Inputs a receiver signal through the coupling capacitor.	
10	ATT (-) input			
11	ATT cont (1)		Attenuator control pin 1. The receiver gain is attenuated 5 dB by setting this pin to the L level.	
12	ATT cont (2)		Attenuator control pin 2. The receiver gain is attenuated 10 dB by setting this pin to the L level.	
13	ATT cont (3)		Attenuator control pin 3. The receiver gain is attenuated 15 dB by setting this pin to the L level.	
14	V <sub>REF</sub>		Reference pin. Connects to GND through the electrolytic capacitor. The current obtainable from this pin is 7mA.	
15	STANDBY		Standby pin. Connects to the Pin <sup>Ⓢ</sup> through a resistor (2MΩ). The standby mode is set by setting this pin to the Low level.	







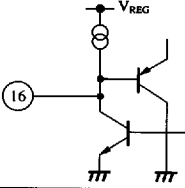
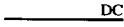
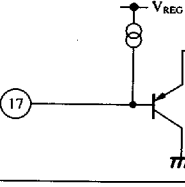

ICs for Telephone

6932852 0013066 499

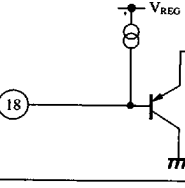
Panasonic

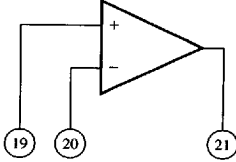
775

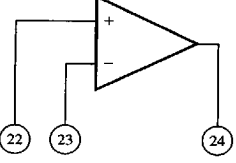



■ Pin Descriptions (cont.)

Pin No.	Pin name	Typical waveform	Description	Equivalent circuit
16	V <sub>CC</sub> cont		Power rise control pin. Connects to GND through the electrolytic capacitor (4.7 μF) and resistor (100k Ω).	
17	REC/SP		Receiver/speaker selector pin. The speaker mode is selected by setting this pin to the H level, and receiver mode by setting to the L level.	
18	MIC mute		Microphone mute pin. Controls ON/OFF of the microphone (3) amplifier. Muted by setting this pin to the L level.	
19	MIC-1 input		Microphone (1) positive and negative input pins. Connects the ECM type microphone through the coupling capacitor.	
20	MIC-1 input			
21	MIC-1 output		Microphone (1) output pin. Capable of driving a 600 Ω load.	
22	MIC-2 input		Microphone (2) positive and negative input pins. Connects the ECM type microphone through the coupling capacitor.	
23	MIC-2 input			
24	MIC-2 output		Microphone (2) output pin. Capable of driving a 600 Ω load.	

■ 6932852 0013067 325 ■

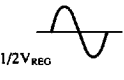
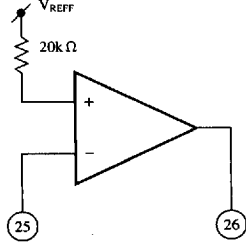
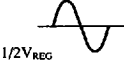
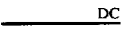
Panasonic

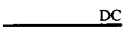
### ■ Pin Descriptions (cont.)

Pin No.	Pin name	Typical waveform	Description	Equivalent circuit
25	MIC-3 input		Microphone (3) input pin. Connects to the microphone (1) or microphone (2) through the coupling capacitor.	
26	MIC-3 output		Microphone (3) output pin. Capable of driving a 600Ω load.	
27	V <sub>REG</sub>		Stabilized supply voltage pin. Connects to GND through the electrolytic capacitor.	
29	V <sub>CC</sub>		Supply voltage pin. Connects to GND through the electrolytic capacitor.	

### ■ Supplementary Descriptions

#### ● Receiver Attenuator

##### ☆ About receiver attenuator

Since the AN6164K and AN6164S incorporate the attenuator circuit in the receiver system, you can adjust an amount of attenuator in 7 steps with the 3 pins, ①, ②, and ③.

The logic table is shown below.

Receiver Attenuation Amount

①	②	③	Attenuation amount (dB)
H	H	H	0
L	H	H	-5
H	L	H	-10
H	H	L	-15
L	H	L	-20
H	L	L	-25
L	L	L	-30
L	L	H	-15

■ 6932852 0013068 261 ■

Panasonic

777

■ Characteristics Curve

Microphone Amp. I/O Distortion Factor Characteristics

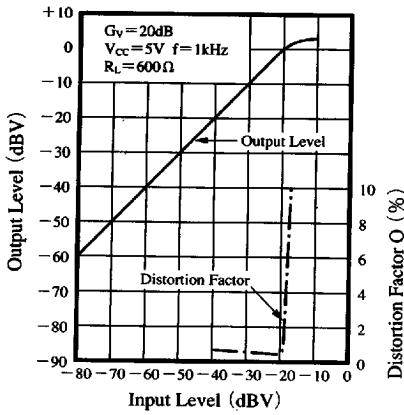

Receiver Amp. I/O Distortion Factor Characteristics

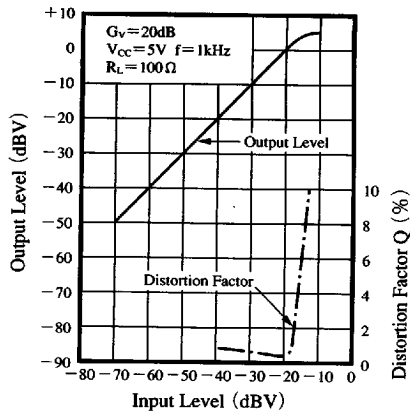

Speaker Amp. I/O Distortion Factor Characteristics

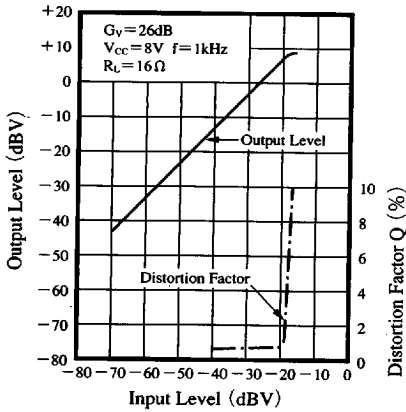

6932852 0013069 1T8

Panasonic