

AN5601K

Color Signal, Video Signal and Synchronous Signal Processing IC for PAL/NTSC TV

Overview

The AN5601K is a single chip integrated circuit in which color signal processing, video signal processing and synchronous signal processing circuits for PAL/NTSC color TV are integrated.

Features

- PAL/NTSC signal processing
- External RGB signal input pin provided
- Compatible with the world set in combination with SECAM signal processing IC (AN5633K).
- Vertical 50/60Hz switching
- Dual loop horizontal AFC
- Sand-castle pulse output pin provided.

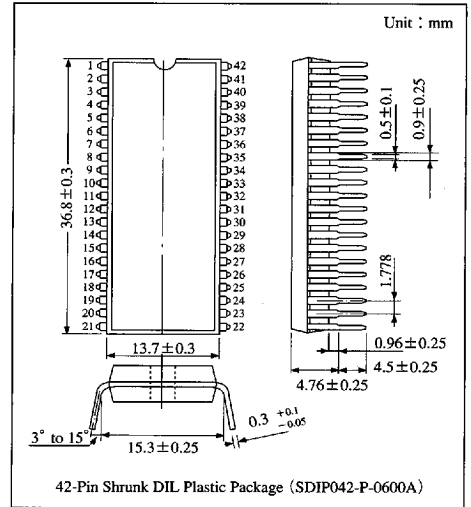

Block Diagram

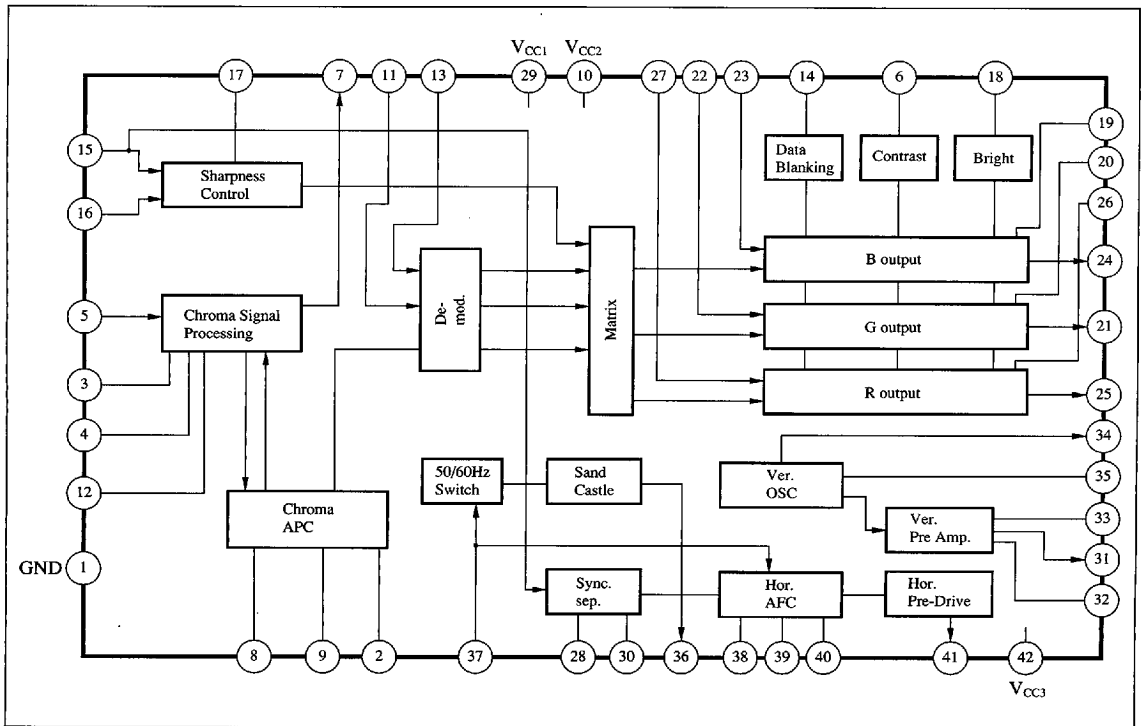

6932852 0014347 177

Panasonic

Absolute Maximum Ratings (Ta = 25°C)

Parameter	Symbol	Rating			Unit
		V _{CC1} = 13.8	V _{CC2} = 6	V _{CC} = 9.5	
Supply voltage	V _{CC}	V _{CC1} = 13.8	V _{CC2} = 6	V _{CC} = 9.5	V
Power dissipation	P _D	1200 *			mW
Operating ambient temperature	T _{opr}	-20 to +70			°C
Storage temperature	T _{stg}	-55 to +150			°C

* Value at Ta = 70°C and mounted on board.

Recommended Operating Range (Ta = 25°C)

Parameter	Symbol	Range
Operating supply voltage range	V _{CC1}	9.6V to 13.8V
	V _{CC2}	4V to 6V

Electrical Characteristics (Ta = 25°C)

Parameter	Symbol	Condition	min	typ	max	Unit
Circuit current	I _{CC1}	V _{CC1} = 12V typ, V _{CC2} = 5V	47	66	80	mA
Circuit current	I _{CC2}	V _{CC2} = 5V typ, V _{CC1} = 12V	8	12	15.5	mA
Circuit current	I _{CC3}	V _{CC1} = 12V, V _{CC2} = 5V, Pin④ = 8.6V	9.5	13.5	17.5	mA
Pin② voltage	V ₂₋₁	V _{CC1} = 12V, V _{CC2} = 5V	2.05	2.6	3.15	V
Pin⑤ voltage	V ₅₋₁	V _{CC1} = 12V, V _{CC2} = 5V	2.15	2.7	3.25	V
Pin⑪ voltage	V _{11-1(PAL)}	V _{CC1} = 12V, V _{CC2} = 5V (PAL Mode)	2.75	3.3	3.85	V
Pin⑬ voltage	V _{13-1(PAL)}	V _{CC1} = 12V, V _{CC2} = 5V (PAL Mode)	2.75	3.3	3.85	V
Pin⑪ voltage	V _{11-1(NTSC)}	V _{CC1} = 12V, V _{CC2} = 5V (NTSC Mode)	1.55	2.1	2.65	V
Pin⑬ voltage	V _{13-1(NTSC)}	V _{CC1} = 12V, V _{CC2} = 5V (NTSC Mode)	1.55	2.1	2.65	V

Chroma System

ACC characteristics	A _{CC}	Color bar input signal Burst 150mV _{PP} -20dB Demodulated output	0.65	0.8	1.12	Times
Demodulated color difference I	e _{0I}	Color bar input Color : max., Contrast : max.	6	7	—	V _{O-P}
Demodulated color difference ratio R/B	R/B	Rainbow input	0.72	0.83	0.9	Times
Demodulated color difference ratio G/B	G/B	Rainbow input	0.31	0.37	0.42	Times
Color killer tolerance (PAL)	e _{K(PAL)}	Color bar input burst 150mV _{P-P} = 0dB Pin② - V _{CC1} 1.8MΩ connected (PAL)	29	34	39	dB
Color killer tolerance (NTSC)	e _{K(NTSC)}	Color bar input burst 150mV _{P-P} = 0dB Pin② - V _{CC1} 1.8MΩ connected (NTSC)	31	36	41	dB
f _o dependent degree to supply voltage	Δf _{OV}	V _{CC1} = 13.8 to 9.6V	—	±60	±120	Hz
Tint variable range	Δθ	Tint control voltage, max. to min.	±35	±45	±55	deg

Video Output System

Video signal output I	A _{V1}	Input stair step, 350mV _{O-P} Cont : max.	5	5.7	6.4	V _{O-P}
Picture quality variable range	Δf _{VP}	Sine wave input, f = 2.5MHz	13.5	17	20	dB
DC regeneration rate	T _{DC}	Input stair step, APL 10 to 90% variable	91	95	—	%
Data blanking level	Data BLK SW	Voltage when output ON/OFF according to the data of BLK-voltage-variation	0.35	—	0.85	V

6932852 0014348 003

Panasonic

Electrical Characteristics (cont.) ($T_a=25^\circ\text{C}$)

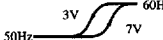
Parameter	Symbol	Condition	min	typ	max	Unit	
Deflection System							
Vertical oscillation start voltage	V_{FV}	Voltage of Pin ²⁹	—	—	6.2	V	
Vertical pulse width	W_{FV}	Pin ³³ C.Ropen (PAL)		500	600	820	μs
Horizontal oscillation start voltage	V_{FH}	Pin ²² voltage measurement	—	5.8	6.2	V	
Horizontal oscillation frequency supply voltage dependency	$\Delta f_{HO(V)}$	$V_{CC3}=6.7$ to 8.5V	—	60	100	Hz	
Horizontal oscillation frequency oscillator sensitivity	β_{HOSC}	$I_o=100\mu\text{A}$	18.5	21	23.5	Hz/ μA	
50Hz/60Hz Switching level (50Hz)	$V_{50/60(1)}$	Pin ³⁷ input		2.5	3	3.5	V
50Hz/60Hz Switching level (60Hz)	$V_{50/60(2)}$			6.5	7	7.5	V
Sand castle pulse burst gate width	WP(Burst)	Output waveform of Pin ³⁶ Burst gate width measurement	PAL	3.8	4	4.2	μs
			NTSC	2.8	3	3.2	
Sand castle pulse V blanking width	WP(VBLK)	Output waveform of Pin ³⁶ VBLK width measurement	50Hz	1.28	1.34	1.4	ms
			60Hz	1.02	1.08	1.14	

6932852 0014349 T4T

Panasonic

Application Circuit

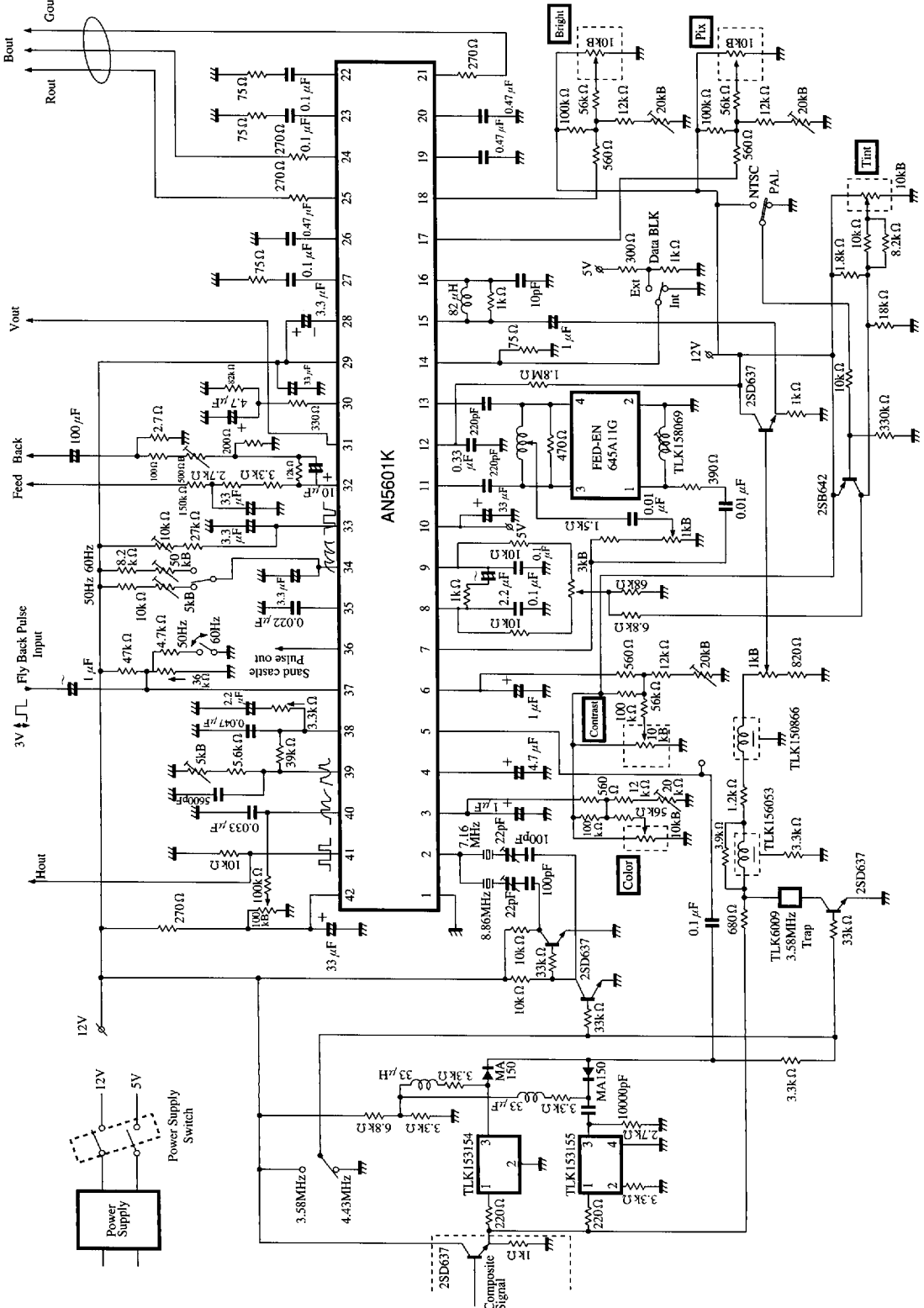

AN5601K

ICs for TV

Panasonic

6932852 0014350 761

Pin Descriptions

Pin No.	Pin name	Description	Typ. waveform	Equivalent circuit
1	GND	GND	_____	_____
2	Chroma VCO Oscillation output	VCO X'tal connection	<p>8.86MHz (PAL) 7.16MHz (NTSC)</p> <p>Oscillation output</p>	
3	Color control	Control the color difference amplitude by changing the pin voltage from 0 to 5V.	_____	
4	ACC filter	ACC amp controlling filter.	5.1VDC	
5	Chroma signal input	Chroma signal input	<p>Standard input (When color bar is input) Signal : 330mV, Burst : 150mV</p>	
6	Contrast control	Control the output amplitude by changing the pin voltage from 1 to 5V. Forcible blanking is activated at pin voltage of 1V or less.	_____	
7	Chroma signal output	ACC amp output.	<p>(When color bar is input) Burst level : 800mV_{PP} 8V_{DC}</p>	

6932852 0014351 6T8

Panasonic

Pin Descriptions (cont.)





Pin No.	Pin name	Description	Typ. waveform	Equivalent circuit
8	Phase detection 1	APC PAL/NTSC switching Tint control in case of NTSC	9.6V _{DC} or more : PAL 9.4V _{DC} or less : NTSC	
9	Phase detection 2			
10	Supply voltage (5V)	Apply supply voltage of 5V	—	—
11	R-Y input	R-Y component input.	<p>Burst level : 100mV_{PP} 3.3V_{DC} (PAL)</p>	
13	B-Y input	B-Y component input	<p>(When color bar is input)</p>	
12	Color killer filter	Color killer amp control filter.	—	
14	Data blanking	Switch the internal TV signal and external RGB signal.	Hi : External RGB signal Lo : Internal TV signal	
15	Video signal input 1	Video signal input	<p>Standard input : 450mV_{PP} Signal component : 315mV_{PP} Sync component : 135mV_{PP} Max. input : 900mV_{PP}</p>	
16	Video signal input 2			
17	Picture control	Control the picture quality by changing the pin voltage from 0 to 5V.	—	

ICs for TV

6932852 0014352 534

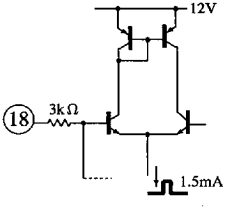
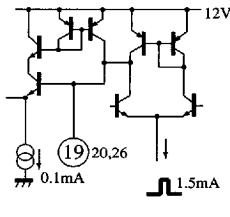
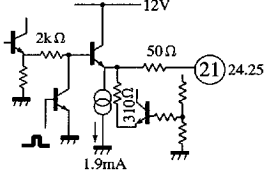
Panasonic

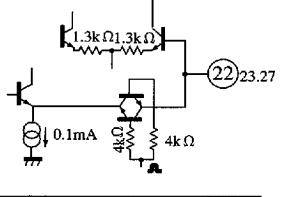
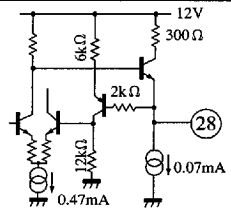
Pin Descriptions (cont.)

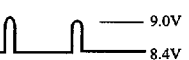
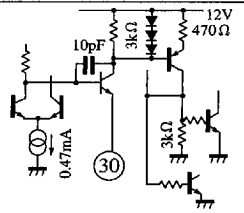
Pin No.	Pin name	Description	Typ. waveform	Equivalent circuit
18	Brightness control	Control the pedestal level of output by changing the pin voltage from 0 to 5V.		
19	Output clamp (B)	Connect the output clamp capacitor.	10.3V _{DC} (When V _{CC1} = 12V)	
20	Output clamp (G)			
26	Output clamp (R)			
21	Original color (G)	R.G.B original color.	Original color : max.10.4V _{PP}	
24	Original color (B)			
25	Original color (R)			
22	External signal (G)	External R.G.B signal input.	Standard input : 900mV _{PP} 	
23	External signal (B)			
27	External signal (R)			
28	Synchronous Separation clamp Noise canceller	Bias output-pin for supplying the comparison voltage to noise canceller circuit of the synchronous signal separation.	DC 9V	
29	Supply voltage (12V) V _{CC1}	Supply voltage pin.	DC 12V	
30	Synchronous Separation filter	Pin for cutting a video-signal for synchronous separation and determining the sampling level of a synchronous signal.		

6932852 0014353 470

Panasonic

■ Pin Descriptions (cont.)

Pin No.	Pin name	Description	Typ. waveform	Equivalent circuit
31	Vertical output V_{OUT}	Vertical drive output pin.		
32	Feedback input	Output feedback pin for compensating the linearity of vertical output, and for improving response.	Waveform to be input 	
33	Vertical oscillation	Perform 45 to 60Hz vertical oscillation.		
34	Vertical hold	Pin for generating sawtooth-wave voltage for vertical drive.		
35	Vertical integration	Low pass filter pin for performing the vertical synchronous separation and pulling-in vertical oscillation.		
36	Sand castle Pulse output	Superimpose V_{BLK} , H_{BLK} and BP pulses for output. $BP = 3 \mu s \cdot 4 \mu s$ $H_{BLK} = 11 \text{ to } 12 \mu s$ $V_{BLK} = 1100 \mu s \cdot 1350 \mu s$		
37	50Hz/60Hz Switching Flyback Pulse input	Use as a pin for FB-pulse-input and pin for V_{BLK} -pulse-width-switching at 50Hz and 60Hz.	Waveform to be input At 60Hz: At 50Hz:	

ICs for TV

6932852 0014354 307

Panasonic

■ Pin Descriptions (cont.)

Pin No.	Pin name	Description	Typ. waveform	Equivalent circuit
38	Horizontal AFC output	AFC-current push-pull pin.		
39	Horizontal oscillation	Perform 30 to 32kHz horizontal oscillation (double f_H oscillation).		
40	Horizontal center adjustment	DC level-adjusting-pin for adjusting the screen position in a horizontal direction.		
41	Horizontal output	Horizontal drive output pin.		
42	Horizontal supply voltage V_{CC3}	The horizontal supply voltage pin by built-in zenerdiode. I_{CC3} requires about 12mA.	DC8.6V	

■ Supplementary Explanation

• Design Reference Value of Electrical Characteristics ($T_a=25^{\circ}C$)

Parameter	Symbol	Condition	min	typ	max	Unit
Chroma System						
fo Change with ambient temperature	Δf_{OT}	$V_{CC1}=12V, V_{CC2}=5V$	—	-2	—	Hz/°C
Demodulation angle (Color difference) $\angle R$	$\angle R$	Based on $\angle B$	86.5	90	93.5	deg
Demodulation angle (Color difference) $\angle G$	$\angle G$	Based on $\angle G$	229	236	244	deg
APC pull-in range (1)	$f_P(PAL)$	PAL Mode 4.43MHz	500	700	—	Hz
APC pull-in range (2)	$f_P(NTSC)$	NTSC Mode 3.58MHz	500	700	—	Hz

Panasonic

■ 6932852 0014355 243 ■

• Design Reference Value of Electrical Characteristics (cont.) (Ta=25°C)

Parameter	Symbol	Condition	min	typ	max	Unit
Video Output System						
Bright control sensitivity	S _{BR}	Δ (Output DC) / Δ (Bright voltage)	1.7	1.9	2.1	—
Video frequency characteristics	f _v	Pix typ-3dB point	6	—	—	MHz
RGB external input signal internal RGB signal crosstalk	CT INT-EXT	Crosstalk when data blanking is switched	46	—	—	dB
Data switching time	td	V _{CC1} = 12V, V _{CC2} = 5V	—	—	20	ns
PAL/NTSC switching level	V _{SPAL/NTSC}	PAL/NTSC demodulation when PAL signal input and R-Y output	8.8	9.2	9.7	V
Deflection System						
Vertical oscillation frequency ambient temperature dependency	$\Delta f_{VO-(T)}$	-20 to +70°C temperature change V _{CC1} = 12V V _{CC2} = 5V	-220	-170	0	ppm/°C
Horizontal oscillation frequency ambient temperature dependency	$\Delta f_{HO-(T)}$	-20 to +70°C temperature change V _{CC1} = 12V V _{CC2} = 5V	-210	-100	0	ppm/°C
Sand castle pulse level (V)	V _{SC-V}	V _{CC1} = 12V, V _{CC2} = 5V, Pin③ output	1.8	2.3	2.8	V
Sand castle pulse level (H)	V _{SC-H}	V _{CC1} = 12V, V _{CC2} = 5V, Pin③ output	4.8	5.3	5.8	V
Sand castle pulse level (Burst gate)	V _{SC-Bur}	V _{CC1} = 12V, V _{CC2} = 5V, Pin③ output	10.5	11	11.5	V

Note) The value in the above characteristics is not a guaranteed value, but reference one on design.



• Characteristic Curve

Contrast Control Characteristics

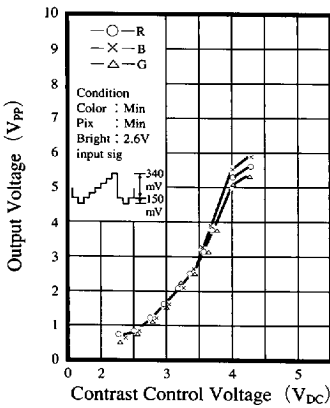

Tint Variable Range

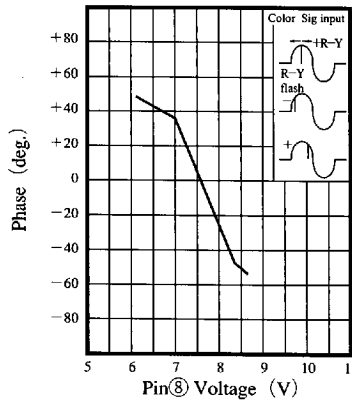

Brightness Control Characteristics

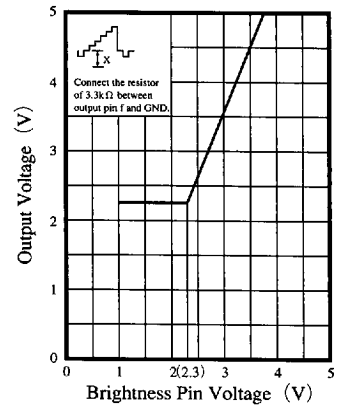

P_D-T_a Characteristics

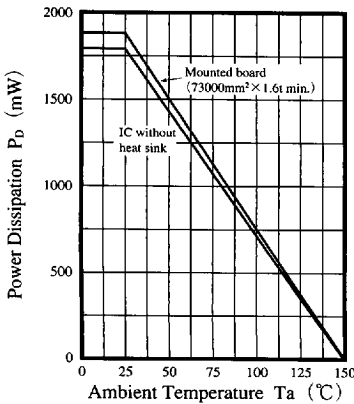

6932852 0014356 18T

Panasonic