

AN2493FH

Luminance and chrominance signal processing (PAL) IC
for 8 mm VCR

■ Overview

The AN2493FH is a single chip LSI designed for a Y/C main signal processing of PAL system normal 8 mm video. System cost can be cut down drastically by built-in of external filters and fc automatic adjustment.

■ Features

- 5 V single power supply
- Reduction of external components and adjustment parts by adopting of automatic adjustment filters.
- No need of glass delay lines.

■ Applications

- 8 mm videos and 8 mm video cameras

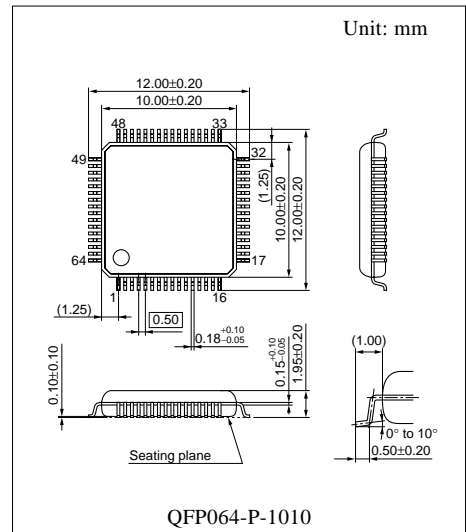

■ Block Diagram

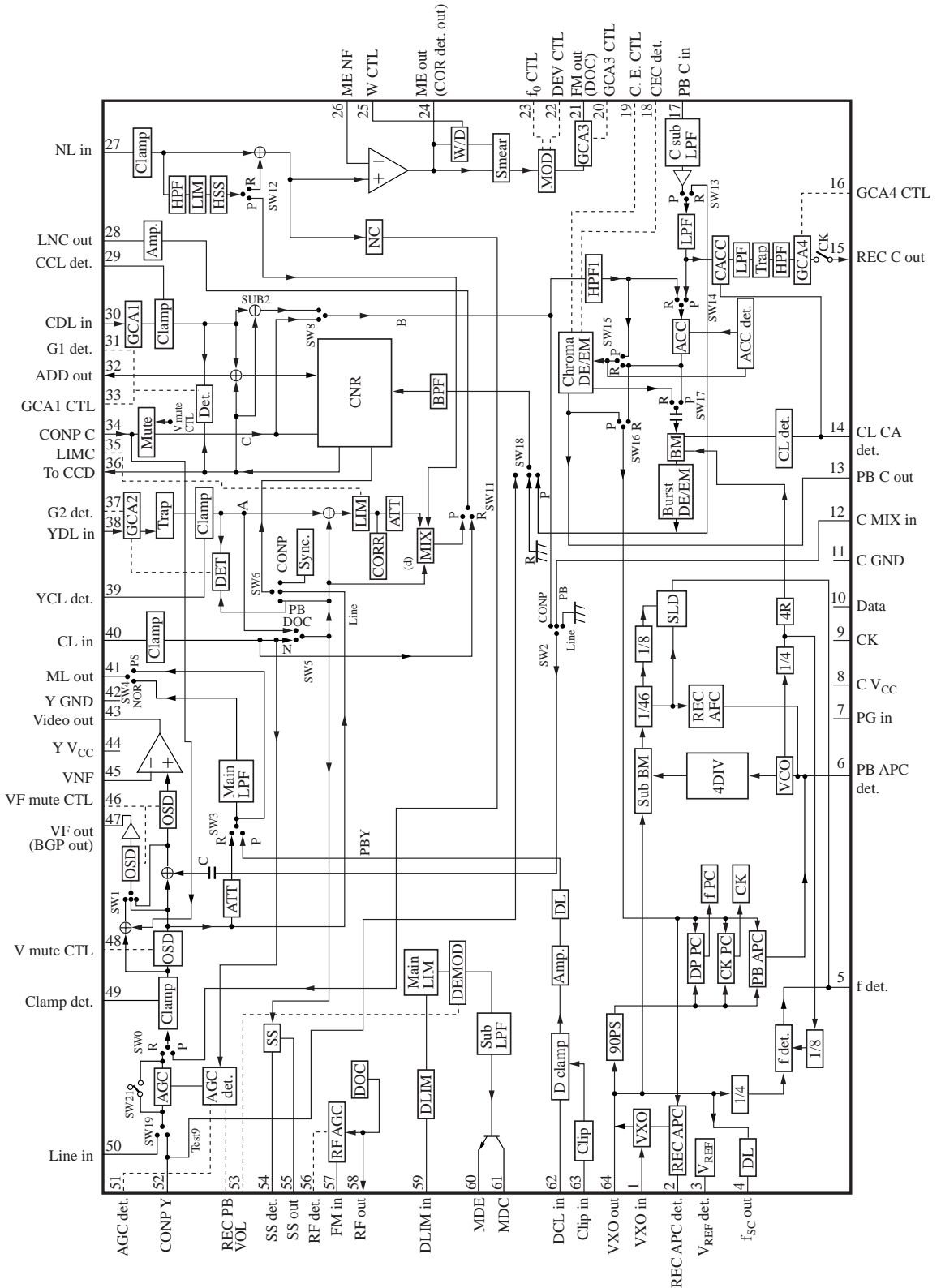

■ Pin Descriptions

Pin No.	Description	Pin No.	Description
1	VXO in	33	GCA1 CTL
2	REC APC det.	34	CONP C
3	V _{REF} det.	35	LIMC
4	f _{SC} out	36	To CCD
5	f det.	37	G2 det.
6	PB APC det.	38	YDL in
7	PG in.	39	YCL det.
8	C V _{CC}	40	CL in
9	CK	41	ML out
10	Data	42	Y GND
11	C GND	43	Video out
12	C MIX in	44	Y V _{CC}
13	PB C out	45	VNF
14	CL CA det.	46	VF mute CTL
15	REC C out	47	VF out (BGP out)
16	GCA4 CTL	48	V mute CTL
17	PB C in	49	Clamp det.
18	CEC det.	50	Line in
19	Chroma emph. CTL	51	AGC det.
20	GCA3 CTL	52	CONP Y
21	FM out (DOC)	53	REC PB VOL
22	DEV CTL	54	SS det.
23	f ₀ CTL	55	SS out
24	ME out (COR det. out)	56	RF det.
25	W CTL	57	FM in
26	ME NF	58	RF out
27	NL in	59	DLIM in
28	LNC out	60	MDE
29	CCL det.	61	MDC
30	CDL in	62	DCL in
31	G1 det.	63	Clip in
32	ADD out	64	VXO out

■ Absolute Maximum Ratings

Parameter	Symbol	Rating	Unit
Supply voltage	V_{CC}	5.5	V
Supply current	I_{CC}	100	mA
Power dissipation *2	P_D	359	mW
Operating ambient temperature *1, *3	T_{opr}	-10 to +70	°C
Storage temperature *1	T_{stg}	-55 to +125	°C

Note) *1: Except for the power dissipation, operating ambient temperature and storage temperature, all ratings are for $T_a = 25^\circ\text{C}$.

*2: The power dissipation shown is for the IC package at $T_a = 70^\circ\text{C}$.

$P_D = 696$ (mW) ($T_a = 70^\circ\text{C}$) when mounted on the glass epoxy printed circuit board of $50 \times 50 \times 0.8$ (mm³).

*3: It becomes = 471(mW) at supply voltage $V_{CC} = 4.8$ V.

■ Recommended Operating Range

Parameter	Symbol	Range	Unit
Supply voltage	V_{CC}	4.7 to 5.2	V

■ Electrical Characteristics at $V_{CC} = 4.8$ V, $T_a = 25^\circ\text{C}$

Parameter	Symbol	Conditions	Min	Typ	Max	Unit
Consumption current 1	I_{CC1}	Consumption current at recording	52	72	92	mA
Consumption current 2	I_{CC2}	Consumption current at playback	58	78	98	mA
Consumption current 3	I_{CC3}	Power save mode	42	62	82	mA
Consumption current 4	I_{CC4}	Camera power save mode	-8	-4.2	-1	mA
Internal reference voltage source	V_{REF}	Pin 3 voltage	—	2.5	—	V
REC overall	V_{ME}	Adjust pin 47 output voltage to 1 V[p-p] at pin 53	-14	-12	-10	dB
Y-AGC control characteristics	ΔV_{AGC}	Pin 47 output gain ratio between 0.5 V[p-p] and 2.0 V[p-p] inputs	-1.5	0	1.5	dB
Y-AGC through mode	V_{26S}	Pin 24 output at pin 50 input	200	250	300	mV[p-p]
View finder amp. frequency characteristics	f_{BA}	Output ratio of 5 MHz to 100 kHz at input of 100 kHz or 5 MHz	-1.5	0	1.5	dB
Video-OSD white mute level	V_{OW}	DC voltage referred to pedestal level	56	68	80	IRE
Video-OSD black mute level	V_{OB}	DC voltage referred to pedestal level	-5	5	15	IRE
Video-OSD white mute CTL voltage	V_{48W}	Pin 48 input at inserting recording character	3.6	—	4.8	V
Video-OSD black mute CTL voltage	V_{48B}	Pin 48 input at inserting recording character	2.0	—	2.6	V
Video-OSD through CTL voltage	V_{48S}	Pin 48 input at inserting recording character	0	—	1.0	V

■ Electrical Characteristics at $T_a = 25^\circ\text{C}$ (continued)

Parameter	Symbol	Conditions	Min	Typ	Max	Unit
Video-OSD quasi-V level	V_{OV}	DC voltage difference referred to sync. tip in PB mode	-50	0	50	mV
Video-OSD quasi-V mute CTL voltage	V_{48V}	Pin 48 input in PB mode	2.0	—	4.8	V
Video-OSD through CTL voltage	V_{48G}	Pin 48 input in PB mode	0	—	1.0	V
Y-main-LPF frequency characteristics 1	Δf_{ML1}	Output ratio of 3 MHz to 100 kHz at input of 100 kHz or 3 MHz	-5	-1	2	dB
Y-main-LPF frequency characteristics 2	Δf_{ML2}	Output ratio of 4.43 MHz to 100 kHz at input of 100 kHz or 4.43 MHz	—	—	-25	dB
Video amp. output amplitude	V_{VO}	Adjust the VF out to 1 V[p-p]	1.75	2.0	2.25	V[p-p]
Video amp. frequency characteristics	f_{V1}	Output ratio of 5 MHz to 100 kHz at input of 100 kHz or 5 MHz	-1.5	0	1.5	dB
View finder OSD-white mute level	V_{BOV}	DC voltage referred to pedestal level	56	68	80	IRE
View finder OSD-black mute level	V_{BOB}	DC voltage referred to pedestal level	-5	5	15	IRE
View finder OSD-white mute CTL voltage	V_{46W}	Pin 48 = 0 V, an indication character is inserted	3.6	—	4.8	V
View finder OSD-black mute CTL voltage	V_{46B}	Pin 48 = 0 V, an indication character is inserted	2.0	—	2.6	V
View finder OSD through CTL voltage	V_{46S}	Pin 48 = 0 V, an indication character is inserted	0	—	1.0	V
View finder OSD quasi-V level	V_{BOV}	DC voltage referred to sync. tip at PB mode	-50	0	50	mV
View finder OSD quasi-V mute CTL voltage	V_{B48V}	Pin 48 input in PB mode	2.0	—	4.8	V
View finder OSD through CTL voltage	V_{B48S}	Pin 48 input in PB mode	0	—	1.0	V
PB OSD white mute level	V_{POW}	DC voltage referred to pedestal level	56	68	80	IRE
PB OSD black mute level	V_{POB}	DC voltage referred to pedestal level	-5	5	15	IRE
PB OSD white mute CTL voltage	V_{46W}	Pin 48 = 0 V, an indication character is inserted	3.6	—	4.8	V
PB OSD black mute CTL voltage	V_{46B}	Pin 48 = 0 V, an indication character is inserted	2.0	—	2.6	V
PB OSD through CTL voltage	V_{46S}	Pin 48 = 0 V, an indication character is inserted	0	—	1.0	V
PB OSD off	V_{VOO}	Pin 48 = 0 V, an indication character is inserted	1.75	2.0	2.25	V[p-p]

■ Electrical Characteristics at $T_a = 25^\circ\text{C}$ (continued)

Parameter	Symbol	Conditions	Min	Typ	Max	Unit
Sync. separation min. input sensitivity	V_{SS}	Input sync. level	—	—	65	mV[p-p]
Sync. separation pulse delay amount	t_{SS}	Sync. delay measurement between pin 40 and pin 55	560	760	960	ns
Sync. separation output amplitude 1	V_{SSH}	Output amplitude of pin 55	4.0	—	—	V
Sync. separation output amplitude 2	V_{SSL}	Output amplitude of pin 55	—	—	0.4	V
Non linear emphasis 1	f_{RNL1}	Output ratio of 1 MHz to 10 kHz at input 0 dB	1.0	3.0	5.0	dB
Non linear emphasis 2	f_{RNL2}	Output ratio of 1 MHz to 10 kHz at input -10 dB	3.7	6.2	8.7	dB
Non linear emphasis 3	f_{RNL3}	Output ratio of 1 MHz to 10 kHz at input -20 dB	6.3	9.3	12.3	dB
Non linear de-emphasis 1	f_{PNL1}	Output ratio of 1 MHz to 10 kHz at input 0 dB	-5.0	-3.0	-1.0	dB
Non linear de-emphasis 2	f_{PNL2}	Output ratio of 1 MHz to 10 kHz at input -10 dB	-10	-7.5	-5.0	dB
Non linear de-emphasis 3	f_{PNL3}	Output ratio of 1 MHz to 10 kHz at input -20 dB	-11.5	-8.5	-5.5	dB
Dark clip level	V_{CD}	Fixed	90	100	110	%
White clip level	V_{CW}	Adjust at pin 25	—	220	—	%
FM carrier interleave	V_{CI}	Apply voltage to pin 7	—	1.64	—	mV[p-p]
FM modulator oscillation frequency	f_0	Adjust at pin 23	—	4.2	—	MHz
FM modulator deviation CTL	f_{DEV}	Apply voltage to pin 27 and adjust at pin 22	—	2.4	—	MHz/V
FM modulator second harmonic distortion	$2f_{FM}$	Pin 21 output	—	—	-30	dB
Y-FM-GCA output amplitude 1	V_{FMS}	Pin 20 = 0 V	—	—	100	mV[p-p]
Y-FM-GCA output amplitude 2	V_{FML}	Pin 20 = 4.8 V	370	—	—	mV[p-p]
PB-Y-RFAGC output amplitude	V_{58}	Input 50 mV[p-p] and 200 mV[p-p] at $f = 5$ MHz	325	400	475	mV[p-p]
PB-Y-RFAGC output second harmonic distortion	$2f_{58}$	Input 100 mV[p-p], $f = 5$ MHz	—	—	-30	dB
PB-over-all 1 (NOR)	V_{NOR}	Adjust pin 47 output voltage at pin 53	—	1.0	—	V[p-p]
FM demodulation linearity 1	ΔV_{NOR}	Adjust at pin 53, input 3, 5 and 7 MHz, pin 63 = 4.8 V	90	100	110	%

■ Electrical Characteristics at $T_a = 25^\circ\text{C}$ (continued)

Parameter	Symbol	Conditions	Min	Typ	Max	Unit
Dropout detection on level	V_{DOC}	Input at pin 57, $f = 5$ MHz	-17	-12	-7	dB
Dropout detection off hysteresis	ΔV_{DOC}	Input at pin 57, $f = 5$ MHz	1	4	10	dB
Dropout detection ENV off	V_{DOCH}	Input at pin 57, $f = 5$ MHz	5	8	11	H
Dropout detection output high-level	V_{P21H}	Pin 21 output, pin 57 input	2.8	—	—	V
Dropout detection output low-level	V_{P21L}	Pin 21 output, pin 57 input	—	—	0.4	V
Noise canceller frequency characteristics 1	f_{NC11}	Output ratio of 1 MHz to 50 kHz at input 0 dB, NC1 mode	-3	-0.3	0.5	dB
Noise canceller frequency characteristics 2	f_{NC12}	Output ratio of 1 MHz to 50 kHz at input -10 dB, NC1 mode	-3.5	-0.8	0.5	dB
Noise canceller frequency characteristics 3	f_{NC13}	Output ratio of 1 MHz to 50 kHz at input -20 dB, NC1 mode	-6	-2.3	0	dB
Noise canceller frequency characteristics 4	f_{NC14}	Output ratio of 1 MHz to 50 kHz at input -30 dB, NC1 mode	-10	-6.5	-3.0	dB
NC off mode	f_{NCOFF}	Output ratio of 1 MHz to 50 kHz at input -30 dB, NC1 mode and NC off	-10	-6.5	-3.0	dB
Clip comp. limiter level	V_{CL}	Pin 41 output, pin 63 input	45	70	95	mV
Line noise canceller frequency characteristics 1	f_{LNC1}	Input 0 dB	-2.2	-0.2	1.8	dB
Line noise canceller frequency characteristics 2	f_{LNC2}	Input -30 dB	-15.0	-8.5	-3.0	dB
Line noise canceller (off)	f_{LN3}	Input -30 dB	-1.5	0	1.5	dB
C-BPF frequency characteristics 1	f_{BP1}	Output ratio of 4.13 MHz to 4.43 MHz at input 100 mV[p-p]	-2.5	-0.5	1.5	dB
C-BPF frequency characteristics 2	f_{BP2}	Output ratio of 4.73 MHz to 4.43 MHz at input 100 mV[p-p]	-2.5	-0.5	1.5	dB
C-BPF frequency characteristics 3	f_{BP3}	Output ratio of 2.93 MHz to 4.43 MHz at input 100 mV[p-p]	—	—	-20	dB
C-BPF+HPF frequency characteristics 4	f_{BP4}	Output ratio of 5.93 MHz to 4.43 MHz at input 100 mV[p-p]	—	—	-18	dB
REC APC pull-in range 1	$+\Delta f_{\text{SC}}$	Pin 4 output (designated Xtal), at input $f_{\text{SC}} + 300$ Hz	275	—	—	Hz
REC APC pull-in range 2	$-\Delta f_{\text{SC}}$	Pin 4 output (designated Xtal), at input $f_{\text{SC}} - 300$ Hz	—	—	-275	Hz
Xtal output amplitude	V_{FSC}	Pin 4 output at lock (designated Xtal)	320	520	720	mV[p-p]
Xtal oscillation frequency	f_{SC}	Frequency deviation of pin 4 at PB	-50	—	50	Hz

■ Electrical Characteristics at $T_a = 25^\circ\text{C}$ (continued)

Parameter	Symbol	Conditions	Min	Typ	Max	Unit
ACC output amplitude	V_{AC}	Pin 15 output (test 3), pin 34 input	270	400	520	mV[p-p]
ACC control characteristics	ΔV_{AC}	Level ratio between input of -14 dB and 6 dB	-2.0	0	2.0	dB
ACC maximum gain	V_{ACM}	Level ratio of output to input	14	20	—	dB
C ACC output characteristics	V_{CAC}	Output burst ratio at input chroma signal of 0 dB and -14 dB	1.0	3	5.0	dB
Burst emphasis amount	V_{BU}	Pin 15 output, pin 34 input	4.0	6.0	8.0	dB
Burst de-emphasis amount	V_{BD}	Pin 13 output, pin 17 input	-8.5	-6.0	-3.5	dB
Chroma de-emphasis characteristics 1	V_{CE1}	Output fsc+500/fsc, input 0 dB	-3.3	—	1.3	dB
Chroma de-emphasis characteristics 2	V_{CE2}	Output fsc-500/fsc, input 0 dB	-3.3	—	1.3	dB
Chroma de-emphasis characteristics 3	V_{CE3}	Output fsc-500/fsc, input -10 dB	-5.8	—	-1.0	dB
Chroma de-emphasis characteristics 4	V_{CE4}	Output fsc+500/fsc, input -10 dB	-5.8	—	-1.0	dB
REC chroma out level 1	V_{RCO1}	Pin15 output, pin 16 = 0 V	—	—	100	mV[p-p]
REC chroma out level 2	V_{RCO2}	Pin15 output, pin 16 = 4.8 V	170	—	—	mV[p-p]
Color killer on level	CK_{ON}	Pin15 DC output at pin 34 input signal of 100 mV[p-p] \rightarrow 2 mV[p-p]	—	—	0.4	V
Color killer off level	CK_{OFF}	Pin15 DC output at pin 34 input signal of 0 mV[p-p] \rightarrow 40 mV[p-p]	1.5	1.9	2.3	V
PB APC pull-in range 1	Δf_{XO1}	Pin 13 output at pin 40 and pin 17 inputs	-100	—	100	Hz
PB APC pull-in range 2	Δf_{XO2}	Pin 13 output at pin 40 and pin 17 inputs	-100	—	100	Hz
CNR characteristics 1	CNR3	White 50% input at pin 40, and B+C signal input at pin 52	-10.5	-7.5	-4.5	dB
CNR characteristics 2	CNR4	White 50% input at pin 40, and B+C signal input at pin 52	-10.5	-7.5	-4.5	dB
PB burst level	V_{PBC}	Burst level at pin 13 output	110	200	280	mV[p-p]
Clip comp. gain	V_{CG}	Pin 41 output at pin 63 input	-8.5	-6	-3.5	dB

■ Terminal Equivalent Circuits

Pin No.	Symbol	Equivalent circuit	Description	Voltage (V)
1	VXO in		<p>400 mV[p-p] f = 4.43 MHz</p>	DC 2.76
2	REC APC det.		Det. pin	DC 2 ± 0.75
3	V _{REF} det.		Bias pin	DC 2.48
4	f _{SC} out		<p>AC 540 mV[p-p] f = 4.43 MHz</p>	DC 2.0

■ Terminal Equivalent Circuits (continued)

Pin No.	Symbol	Equivalent circuit	Description	Voltage (V)
5	f det.		Det. pin	—
6	PB APC det.		Det. pin	DC 1.974 ± 0.75
7	PG in		*High frequency FM out at carrier interleave H	0 ↔ 4.8
8	C V _{CC}	—	—	—
9	CK			0 ↔ 4.8

■ Terminal Equivalent Circuits (continued)

Pin No.	Symbol	Equivalent circuit	Description	Voltage (V)
10	Data			0 ↔ 4.8
11	C GND	—	—	—
12	C MIX in		<p>B: 150 mV[p-p] (PAL)</p> <p>f = 4.4336 MHz (Input with a low impedance)</p>	DC 2.475
13	PB C out		<p>B: 200 mV[p-p] f = 4.4336 MHz</p>	DC 2.145
14	CLCA det.		Det. pin	DC 3.62 ± 0.75

■ Terminal Equivalent Circuits (continued)

Pin No.	Symbol	Equivalent circuit	Description	Voltage (V)
15	REC C out		<p>$f = 732 \text{ kHz}$</p>	DC 2 REC mode
16	CTL 4		REC out level adjustment	$0 \leftrightarrow 4.8$
17	PBC in		<p>B: 100 mV[p-p] $f = 732 \text{ kHz}$</p> <p>Being inputted into PBC-in with Y+C signal, Y signal = 400 mV[p-p]</p>	DC 2.75
18	CEC		Det. pin	DC 2.9

■ Terminal Equivalent Circuits (continued)

Pin No.	Symbol	Equivalent circuit	Description	Voltage (V)
19	CECTL		<p>Chroma emphasis and de-emphasis adjustment pin</p> <p>Adjustment off below 1 V</p>	0 ↔ 4.8
20	CTL 3		REC mode (GCA3 control)	0 ↔ 4.8
21	FM out		<p>DC 3.35 REC mode</p> <p>100 mV to 400 mV</p> <p>PB mode: 2.5 V or more at DOC on 0.4 V and less at DOC off</p>	DC 3.35 REC mode
22	DEV CTL		Adjust to 5.4 MHz with DC at 100% white.	2.5 (typ.) 1.3 to 3.7
23	f ₀ CTL		Adjust FM out to 4.2 MHz at sync. tip.	2.5 (typ.) 1.3 to 3.7

■ Terminal Equivalent Circuits (continued)

Pin No.	Symbol	Equivalent circuit	Description	Voltage (V)
24	ME out		<p>250 mV[p-p]</p>	DC 2.195
25	W CTL		Adjust a white clip level to 220%.	2.0 (typ.) 1.3 to 3.7
26	MENF		<p>250 mV[p-p]</p>	DC 2.19 (sync. tip) (With externally attached feedback resistor R)
27	NL in		<p>500 mV[p-p]</p>	DC 2.93 (sync. tip)

■ Terminal Equivalent Circuits (continued)

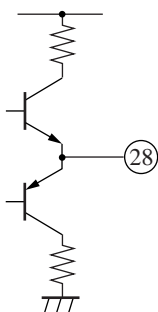
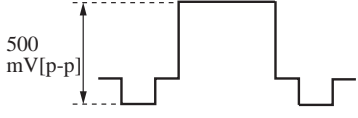
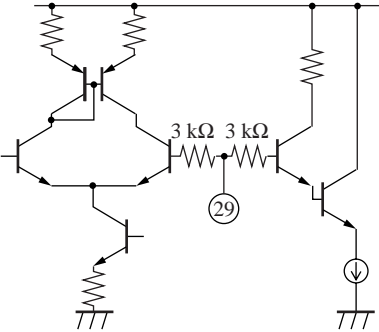
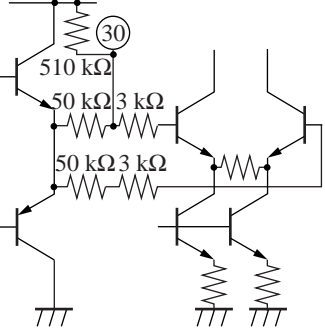
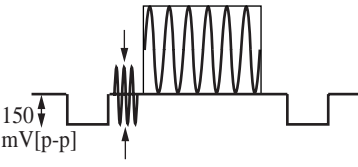
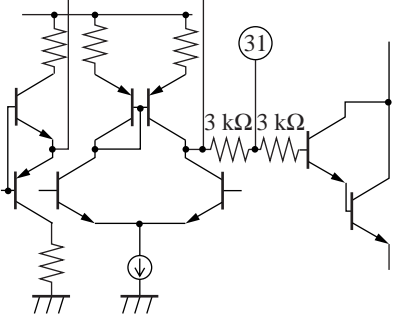
Pin No.	Symbol	Equivalent circuit	Description	Voltage (V)
28	LNC out		 <p>500 mV[p-p]</p>	DC 3.14 (sync. tip)
29	CCL det.		Det. pin	DC 2.66 ± 0.75
30	CDL in		 <p>150 mV[p-p]</p> <p>B: 150 mV[p-p] (PAL) f = 4.4336 MHz</p>	DC 2.755
31	G1 det.		Det. pin	DC 3.515 ± 0.75

■ Terminal Equivalent Circuits (continued)

Pin No.	Symbol	Equivalent circuit	Description	Voltage (V)
32	ADD out		Adjust pin 33 voltage (CTL1) to keep a chroma signal from being mixed.	DC 2.0
33	CTL 1		Chroma level adjustment pin for a comb filter. Adjust so as to be only a Y-signal at pin 32 (ADD out).	DC 2.994
34	CONP C		<p>B: 300 mV[p-p] f = 4.4336 MHz</p>	DC 1.96
35	LIMC		Det. pin	DC 2.7

■ Terminal Equivalent Circuits (continued)

Pin No.	Symbol	Equivalent circuit	Description	Voltage (V)
36	To CCD		<p>B: 150 mV [p-p] f = 4.4336 MHz</p>	DC 2.03 (sync. tip)
37	G2 det.		Det. pin	DC 3.515 ± 0.75
38	YDL in		<p>B: 150 mV [p-p] f = 4.4336 MHz</p>	DC 2.622
39	YCL det.		Det. pin	DC 2.66 ± 0.75

■ Terminal Equivalent Circuits (continued)

Pin No.	Symbol	Equivalent circuit	Description	Voltage (V)
40	CL in		<p>150 mV[p-p] 500 mV[p-p] with 100% white input</p>	DC 3.4 (sync. tip)
41	ML out		<p>150 mV[p-p] 500 mV[p-p] with 100% white input</p>	DC 1.897
42	Y GND	—	—	—
43	Video out		<p>0.6 V[p-p] B: 0.6 V[p-p] f = 4.4336 MHz</p>	DC 1.236 (sync. tip)
44	Y V _{CC}	—	—	—
45	VNF		<p>150 mV[p-p] B: 150 mV[p-p] f = 4.4336 MHz Video amp. is off when pin 45 is 0.3 V or less</p>	DC 1.237 (sync. tip)

■ Terminal Equivalent Circuits (continued)

Pin No.	Symbol	Equivalent circuit	Description	Voltage (V)
46	VF mute		VF amp.-OSD-CTL voltage	0 ↔ 4.8
47	VF out			DC 1.968 (sync. tip)
48	V mute		Video amp.-OSD-CTL voltage	0 ↔ 4.8
49	Clamp det.		Det. pin	DC 3.506

■ Terminal Equivalent Circuits (continued)

Pin No.	Symbol	Equivalent circuit	Description	Voltage (V)
50	Line in		<p>B: 300 mV[p-p] f = 4.4336 MHz (AGC through mode is 6 dB down.)</p>	DC 3.2
51	AGC det.		Det. pin	DC 1.63
52	CONPY		<p>(AGC through mode is 6 dB down.)</p>	DC 3.2
53	REC PB VOL		<p>REC mode: Adjust to 2 V[p-p] at video out. 0.7 V to 4.8 V</p> <p>PB mode: Adjust to 2 V[p-p] at video out. 0.7 V to 4.8 V</p> <p>Filter off mode: 0 V to 0.3 V</p>	<p>Normally 0 ↔ 4.8</p> <p>Filter off 0 ↔ 0.3</p>



■ Terminal Equivalent Circuits (continued)

Pin No.	Symbol	Equivalent circuit	Description	Voltage (V)
54	SS det.		Det. pin	DC 2.78
55	SS out			4 ↔ 0.4
56	RF det.		Det. pin	DC 3
57	FM in		200 mV[p-p]	DC 3.26

■ Terminal Equivalent Circuits (continued)

Pin No.	Symbol	Equivalent circuit	Description	Voltage (V)
58	RF out		400 mV[p-p] 	DC 2.40
59	DLIM in		400 mV[p-p] 	DC 2.49
60	MDE			DC 1.6
61	MDC			DC 3.4

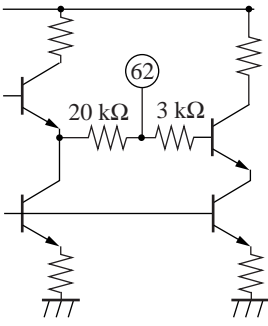
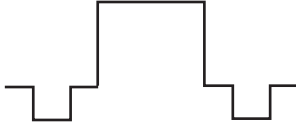
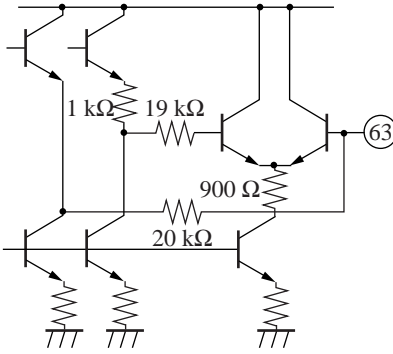
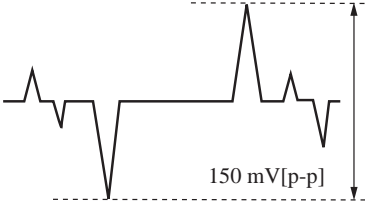
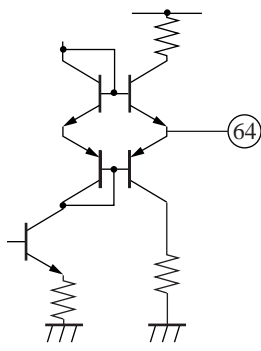
■ Terminal Equivalent Circuits (continued)

Pin No.	Symbol	Equivalent circuit	Description	Voltage (V)
62	DCL in			DC 3.42
63	Clip in			DC 3.4
64	VXO out		 <p>f = 4.4336 MHz</p>	DC 3.33

Application Circuit Example

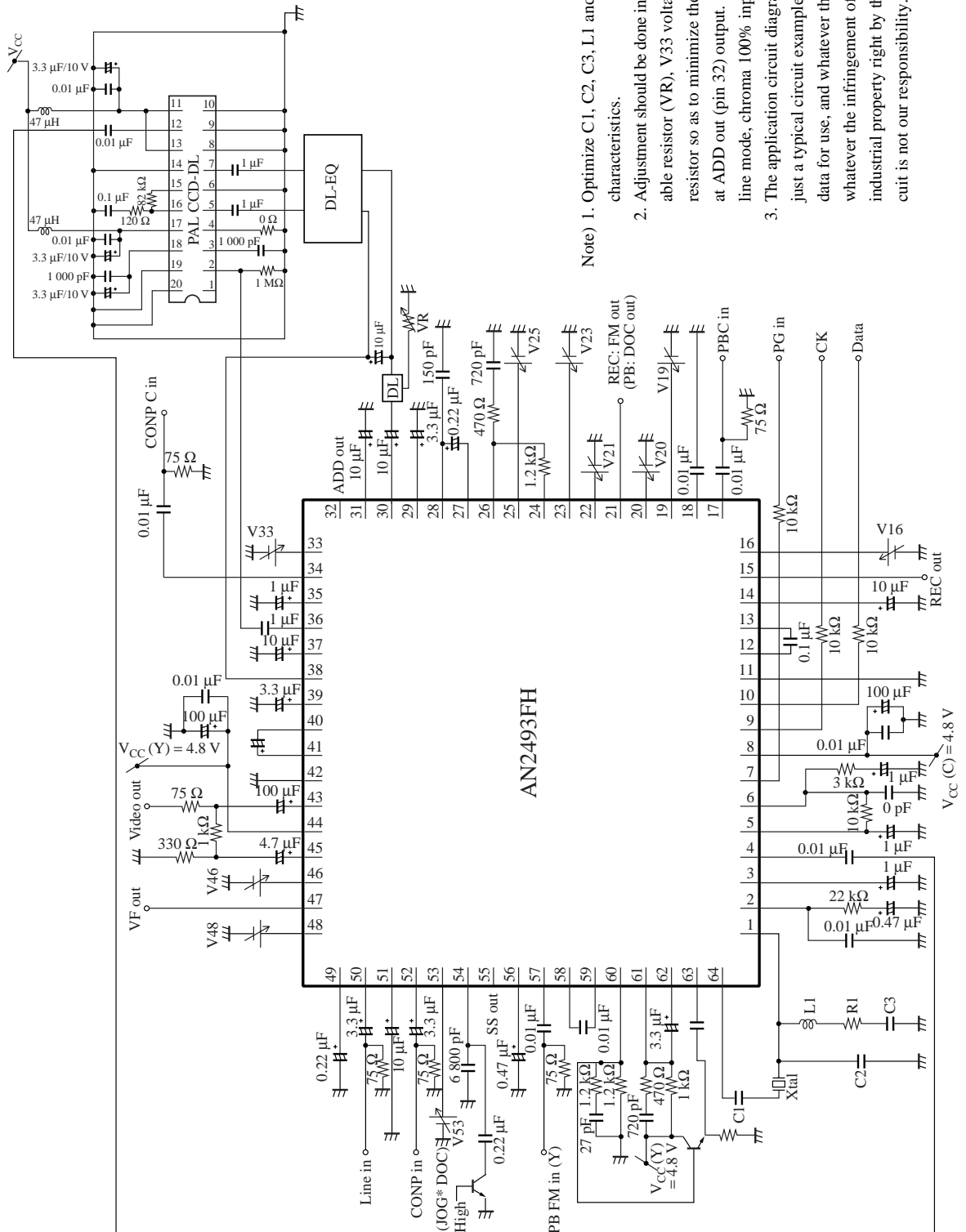

- Note) 1. Optimize C1, C2, C3, L1 and L2 to meet Xtal characteristics.
2. Adjustment should be done in the order of variable resistor (VR), V33 voltage and variable resistor so as to minimize the chroma signal at ADD out (pin 32) output. (At REC mode, line mode, chroma 100% input)
3. The application circuit diagram in this data is just a typical circuit example as a reference for use, and whatever the loss caused or whatever the infringement of the third party's industrial property right by the use of this circuit is not our responsibility.