



# Precision, Very Low Noise, Low Input Bias Current, Wide Bandwidth JFET Operational Amplifiers

## AD8510/AD8512

### FEATURES

**Fast Settling Time:** 500 ns to 0.1%  
**Low Offset Voltage:** 400  $\mu$ V Max  
**Low  $T_cV_{OS}$ :** 1  $\mu$ V/ $^{\circ}$ C Typ  
**Low Input Bias Current:** 25 pA Typ  
**Dual-Supply Operation:**  $\pm$ 5 V to  $\pm$ 15 V  
**Low Noise:** 8 nV/ $\sqrt{\text{Hz}}$   
**Low Distortion:** 0.0005%  
**No Phase Reversal**  
**Unity Gain Stable**

### APPLICATIONS

Instrumentation  
Multipole Filters  
Precision Current Measurement  
Photodiode Amplifiers  
Sensors  
Audio

### GENERAL DESCRIPTION

The AD8510 and AD8512 are single- and dual-precision JFET amplifiers featuring low offset voltage, low input bias current, low input voltage noise, and low input current noise.

The combination of low offsets, low noise, and very low input bias currents makes these amplifiers especially suitable for high impedance sensor amplification and precise current measurements using shunts. The combination of dc precision, low noise, and fast settling time results in superior accuracy in medical instruments, electronic measurement, and automated test equipment. Unlike many competitive amplifiers, the AD8510 and AD8512 maintain their fast settling performance even with substantial capacitive loads.

Fast slew rate and great stability with capacitive loads make the AD8510 and AD8512 a perfect fit for high performance filters.

Low input bias currents, low offset, and low noise result in wide dynamic range in photodiode amplifier circuits.

Low noise and distortion, high output current, and excellent speed make the AD8510 and AD8512 a great choice for audio applications.

Unlike many older JFET amplifiers, the AD8510 and AD8512 do not suffer from output phase reversal when input voltages exceed the maximum common-mode voltage range.

The AD8510 and AD8512 are both available in 8-lead narrow SOIC and 8-lead MSOP packages. MSOP packaged parts are only available in tape and reel.

The AD8510 and AD8512 are specified over the extended industrial ( $-40^{\circ}\text{C}$  to  $+125^{\circ}\text{C}$ ) temperature range.

### REV. B

Information furnished by Analog Devices is believed to be accurate and reliable. However, no responsibility is assumed by Analog Devices for its use, nor for any infringements of patents or other rights of third parties that may result from its use. No license is granted by implication or otherwise under any patent or patent rights of Analog Devices. Trademarks and registered trademarks are the property of their respective companies.

### PIN CONFIGURATIONS

#### 8-Lead MSOP (RM Suffix)

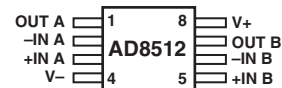

#### 8-Lead SOIC (R Suffix)

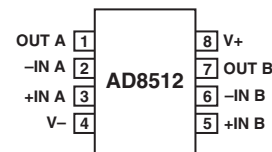

#### 8-Lead MSOP (RM Suffix)

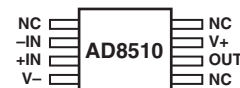

#### 8-Lead SOIC (R Suffix)

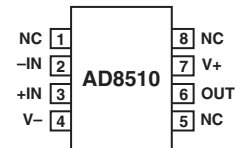

# AD8510/AD8512—SPECIFICATIONS (@ $V_S = \pm 5\text{ V}$ , $V_{CM} = 0\text{ V}$ , $T_A = 25^\circ\text{C}$ , unless otherwise noted.)

Parameter	Symbol	Conditions	Min	Typ	Max	Unit
<b>INPUT CHARACTERISTICS</b>						
Offset Voltage (B Grade)	$V_{OS}$	$-40^\circ\text{C} < T_A < +125^\circ\text{C}$		0.08	0.4	mV
Offset Voltage (A Grade)	$V_{OS}$	$-40^\circ\text{C} < T_A < +125^\circ\text{C}$		0.1	0.8	mV
Input Bias Current	$I_B$	$-40^\circ\text{C} < T_A < +125^\circ\text{C}$		21	1.8	mV
Input Offset Current	$I_{OS}$	$-40^\circ\text{C} < T_A < +85^\circ\text{C}$			75	pA
		$-40^\circ\text{C} < T_A < +125^\circ\text{C}$		5	0.7	nA
		$-40^\circ\text{C} < T_A < +125^\circ\text{C}$				7.5
Input Capacitance						
Differential				12.5		pF
Common-Mode				11.5		pF
Input Voltage Range			-2.0		+2.5	V
Common-Mode Rejection Ratio	CMRR	$V_{CM} = -2.0\text{ V to }+2.5\text{ V}$	86	100		dB
Large Signal Voltage Gain	$A_{VO}$	$R_L = 2\text{ k}\Omega$ , $V_O = -3\text{ V to }+3\text{ V}$	65	107		V/mV
Offset Voltage Drift (B Grade)	$\Delta V_{OS}/\Delta T$			0.9	5	$\mu\text{V}/^\circ\text{C}$
Offset Voltage Drift (A Grade)	$\Delta V_{OS}/\Delta T$			1.7	12	$\mu\text{V}/^\circ\text{C}$
<b>OUTPUT CHARACTERISTICS</b>						
Output Voltage High	$V_{OH}$	$R_L = 10\text{ k}\Omega$ , $-40^\circ\text{C} < T_A < +125^\circ\text{C}$	+4.1	+4.3		V
Output Voltage Low	$V_{OL}$	$-40^\circ\text{C} < T_A < +125^\circ\text{C}$		-4.9	-4.7	V
Output Voltage High	$V_{OH}$	$R_L = 2\text{ k}\Omega$ , $-40^\circ\text{C} < T_A < +125^\circ\text{C}$	+3.9	+4.2		V
Output Voltage Low	$V_{OL}$	$-40^\circ\text{C} < T_A < +125^\circ\text{C}$		-4.9	-4.5	V
Output Voltage High	$V_{OH}$	$R_L = 600\ \Omega$ , $-40^\circ\text{C} < T_A < +125^\circ\text{C}$	+3.7	+4.1		V
Output Voltage Low	$V_{OL}$	$-40^\circ\text{C} < T_A < +125^\circ\text{C}$		-4.8	-4.2	V
Output Current	$I_{OUT}$		$\pm 40$	$\pm 54$		mA
<b>POWER SUPPLY</b>						
Power Supply Rejection Ratio	PSRR	$V_S = \pm 4.5\text{ V to } \pm 18\text{ V}$	86	130		dB
Supply Current/Amplifier	$I_{SY}$	$V_O = 0\text{ V}$ $-40^\circ\text{C} < T_A < +125^\circ\text{C}$		2.0	2.3	mA
					2.5	mA
<b>DYNAMIC PERFORMANCE</b>						
Slew Rate	SR	$R_L = 2\text{ k}\Omega$		20		V/ $\mu\text{s}$
Gain Bandwidth Product	GBP			8		MHz
Settling Time	$t_S$	To 0.1%, 0 V to 4 V Step, $G = +1$		0.4		$\mu\text{s}$
THD + Noise	THD + N	1 kHz, $G = +1$ , $R_L = 2\text{ k}\Omega$		0.0005		%
Phase Margin	$\Phi_o$			44.5		Degrees
<b>NOISE PERFORMANCE</b>						
Voltage Noise Density	$e_n$	$f = 10\text{ Hz}$		34		$\text{nV}/\sqrt{\text{Hz}}$
	$e_n$	$f = 100\text{ Hz}$		12		$\text{nV}/\sqrt{\text{Hz}}$
	$e_n$	$f = 1\text{ kHz}$		8.0	10	$\text{nV}/\sqrt{\text{Hz}}$
	$e_n$	$f = 10\text{ kHz}$		7.6		$\text{nV}/\sqrt{\text{Hz}}$
Peak-to-Peak Voltage Noise	$e_n\text{ p-p}$	0.1 Hz to 10 Hz Bandwidth		2.4	5.2	$\mu\text{V p-p}$

Specifications subject to change without notice.

**ELECTRICAL CHARACTERISTICS** (@  $V_S = \pm 15\text{ V}$ ,  $V_{CM} = 0\text{ V}$ ,  $T_A = 25^\circ\text{C}$ , unless otherwise noted.)

Parameter	Symbol	Conditions	Min	Typ	Max	Unit
<b>INPUT CHARACTERISTICS</b>						
Offset Voltage (B Grade)	$V_{OS}$	$-40^\circ\text{C} < T_A < +125^\circ\text{C}$		0.08	0.4	mV
Offset Voltage (A Grade)	$V_{OS}$	$-40^\circ\text{C} < T_A < +125^\circ\text{C}$		0.1	1.0	mV
Input Bias Current	$I_B$	$-40^\circ\text{C} < T_A < +125^\circ\text{C}$		25	80	pA
Input Offset Current	$I_{OS}$	$-40^\circ\text{C} < T_A < +85^\circ\text{C}$			0.7	nA
		$-40^\circ\text{C} < T_A < +125^\circ\text{C}$		6	75	pA
		$-40^\circ\text{C} < T_A < +85^\circ\text{C}$				0.3
Input Capacitance		$-40^\circ\text{C} < T_A < +125^\circ\text{C}$		Differential	12.5	pF
				Common-Mode	11.5	pF
Input Voltage Range			-13.5		+13.0	V
Common-Mode Rejection Ratio	CMRR	$V_{CM} = -12.5\text{ V to }+12.5\text{ V}$	86	108		dB
Large Signal Voltage Gain	$A_{VO}$	$V_O = -13.5\text{ V to }+13.5\text{ V}$ $R_L = 2\text{ k}\Omega$ , $V_{CM} = 0\text{ V}$	115	196		V/mV
Offset Voltage Drift (B Grade)	$\Delta V_{OS}/\Delta T$			1.0	5	$\mu\text{V}/^\circ\text{C}$
Offset Voltage Drift (A Grade)	$\Delta V_{OS}/\Delta T$			1.7	12	$\mu\text{V}/^\circ\text{C}$
<b>OUTPUT CHARACTERISTICS</b>						
Output Voltage High	$V_{OH}$	$R_L = 10\text{ k}\Omega$ , $-40^\circ\text{C} < T_A < +125^\circ\text{C}$	+14.0	+14.2		V
Output Voltage Low	$V_{OL}$	$-40^\circ\text{C} < T_A < +125^\circ\text{C}$		-14.9	-14.6	V
Output Voltage High	$V_{OH}$	$R_L = 2\text{ k}\Omega$ , $-40^\circ\text{C} < T_A < +125^\circ\text{C}$	+13.8	+14.1		V
Output Voltage Low	$V_{OL}$	$-40^\circ\text{C} < T_A < +125^\circ\text{C}$		-14.8	-14.5	V
Output Voltage High	$V_{OH}$	$R_L = 600\ \Omega$ , $T_A = 25^\circ\text{C}$	+13.5	+13.9		V
		$-40^\circ\text{C} < T_A < +125^\circ\text{C}$	11.4			V
Output Voltage Low	$V_{OL}$	$R_L = 600\ \Omega$ , $T_A = 25^\circ\text{C}$		-14.3	-13.8	V
		$-40^\circ\text{C} < T_A < +125^\circ\text{C}$			-12.1	V
Output Current	$I_{OUT}$			$\pm 45$		mA
<b>POWER SUPPLY</b>						
Power Supply Rejection Ratio	PSRR	$V_S = \pm 4.5\text{ V to } \pm 18\text{ V}$	86			dB
Supply Current/Amplifier	$I_{SY}$	$V_O = 0\text{ V}$ $-40^\circ\text{C} < T_A < +125^\circ\text{C}$		2.2	2.5	mA
					2.6	mA
<b>DYNAMIC PERFORMANCE</b>						
Slew Rate	SR	$R_L = 2\text{ k}\Omega$		20		V/ $\mu\text{s}$
Gain Bandwidth Product	GBP			8		MHz
Settling Time	$t_s$	To 0.1%, 0 V to 10 V Step, $G = +1$		0.5		$\mu\text{s}$
		To 0.01%, 0 V to 10 V Step, $G = +1$		0.9		$\mu\text{s}$
THD + Noise	THD + N	1 kHz, $G = +1$ , $R_L = 2\text{ k}\Omega$		0.0005		%
Phase Margin	$\Phi_o$			52		Degrees
<b>NOISE PERFORMANCE</b>						
Voltage Noise Density	$e_n$	$f = 10\text{ Hz}$		34		$\text{nV}/\sqrt{\text{Hz}}$
	$e_n$	$f = 100\text{ Hz}$		12		$\text{nV}/\sqrt{\text{Hz}}$
	$e_n$	$f = 1\text{ kHz}$		8.0	10	$\text{nV}/\sqrt{\text{Hz}}$
	$e_n$	$f = 10\text{ kHz}$		7.6		$\text{nV}/\sqrt{\text{Hz}}$
Peak-to-Peak Voltage Noise	$e_n\text{ p-p}$	0.1 Hz to 10 Hz Bandwidth		2.4	5.2	$\mu\text{V p-p}$

Specifications subject to change without notice.

# AD8510/AD8512

## ABSOLUTE MAXIMUM RATINGS\*

Supply Voltage	±18 V
Input Voltage	±V <sub>S</sub>
Output Short-Circuit Duration to GND	Observe Derating Curves
Storage Temperature Range	
R, RM Packages	−65°C to +150°C
Operating Temperature Range	−40°C to +125°C
Junction Temperature Range	
R, RM Packages	−65°C to +150°C
Lead Temperature Range (Soldering, 10 sec)	300°C
Electrostatic Discharge (HBM)	2000 V

\*Stresses above those listed under Absolute Maximum Ratings may cause permanent damage to the device. This is a stress rating only; functional operation of the device at these or any other conditions above those listed in the operational sections of this specification is not implied. Exposure to absolute maximum rating conditions for extended periods may affect device reliability.

Package Type	θ <sub>JA</sub> *	θ <sub>JC</sub>	Unit
8-Lead MSOP (RM)	210	45	°C/W
8-Lead SOIC (R)	158	43	°C/W

\*θ<sub>JA</sub> is specified for worst-case conditions, i.e., θ<sub>JA</sub> is specified for device soldered in circuit board for surface-mount packages.

## ORDERING GUIDE

Model	Temperature Range	Package Description	Package Option	Branding Information
AD8510ARM-Reel	−40°C to +125°C	8-Lead MSOP	RM-8	B7A
AD8510AR	−40°C to +125°C	8-Lead SOIC	R-8	
AD8510AR-Reel	−40°C to +125°C	8-Lead SOIC	R-8	
AD8510AR-Reel7	−40°C to +125°C	8-Lead SOIC	R-8	
AD8510BR	−40°C to +125°C	8-Lead SOIC	R-8	
AD8510BR-Reel	−40°C to +125°C	8-Lead SOIC	R-8	
AD8510BR-Reel7	−40°C to +125°C	8-Lead SOIC	R-8	
AD8512ARM-Reel	−40°C to +125°C	8-Lead MSOP	RM-8	B8A
AD8512AR	−40°C to +125°C	8-Lead SOIC	R-8	
AD8512AR-Reel	−40°C to +125°C	8-Lead SOIC	R-8	
AD8512AR-Reel7	−40°C to +125°C	8-Lead SOIC	R-8	
AD8512BR	−40°C to +125°C	8-Lead SOIC	R-8	
AD8512BR-Reel	−40°C to +125°C	8-Lead SOIC	R-8	
AD8512BR-Reel7	−40°C to +125°C	8-Lead SOIC	R-8	

## CAUTION

ESD (electrostatic discharge) sensitive device. Electrostatic charges as high as 4000 V readily accumulate on the human body and test equipment and can discharge without detection. Although the AD8510/AD8512 feature proprietary ESD protection circuitry, permanent damage may occur on devices subjected to high energy electrostatic discharges. Therefore, proper ESD precautions are recommended to avoid performance degradation or loss of functionality.



# Typical Performance Characteristics—AD8510/AD8512

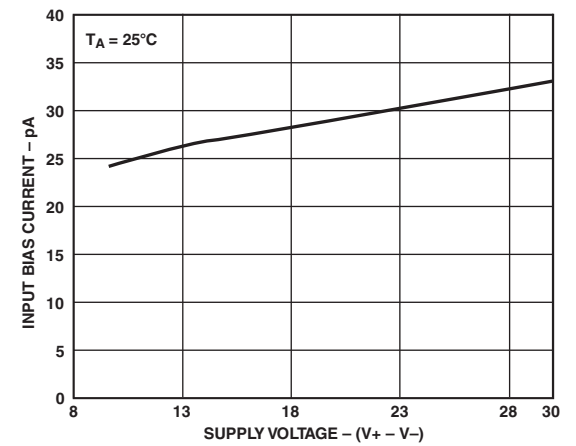
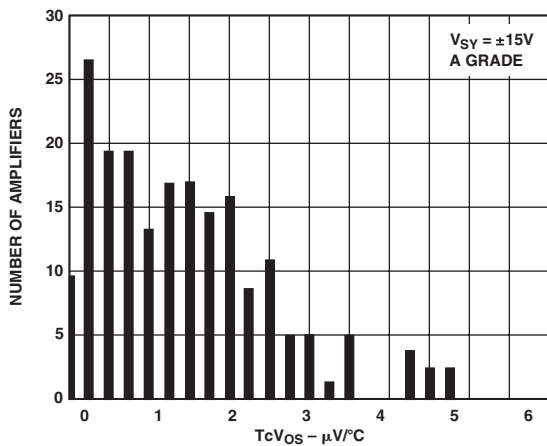
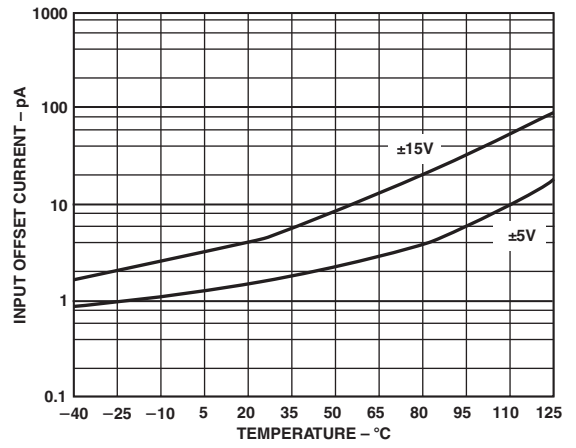
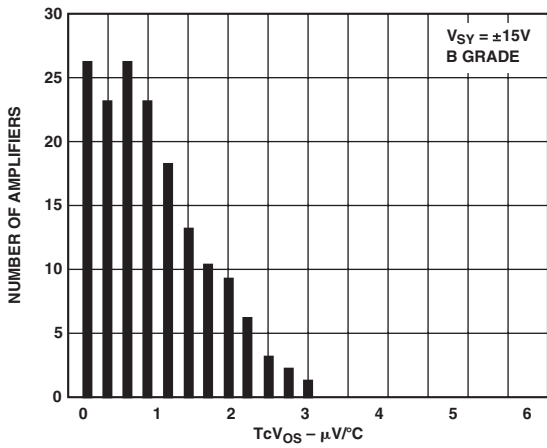
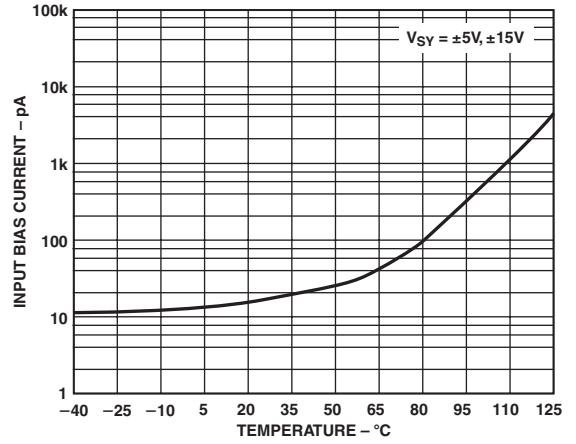
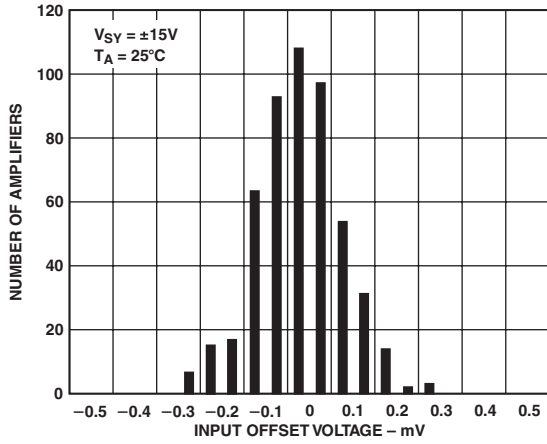

# AD8510/AD8512

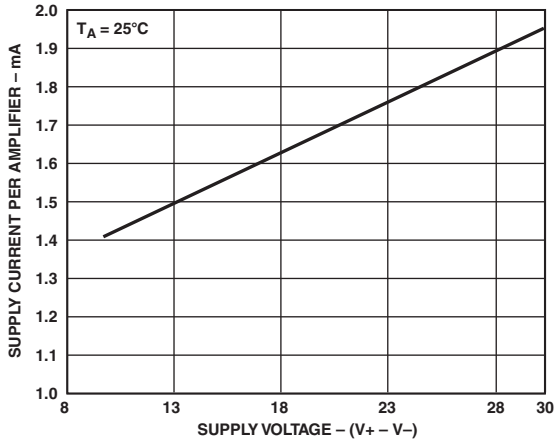

TPC 7. AD8512 Supply Current Per Amplifier vs. Supply Voltage

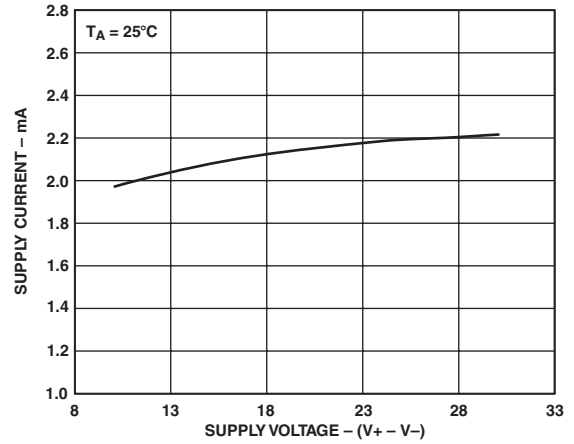

TPC 10. AD8510 Supply Current vs. Supply Voltage

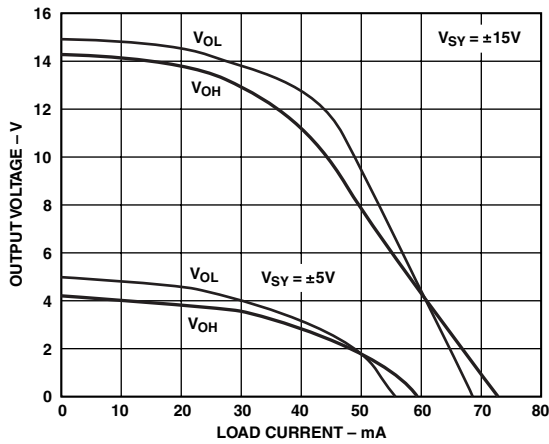

TPC 8. Output Voltage vs. Load Current

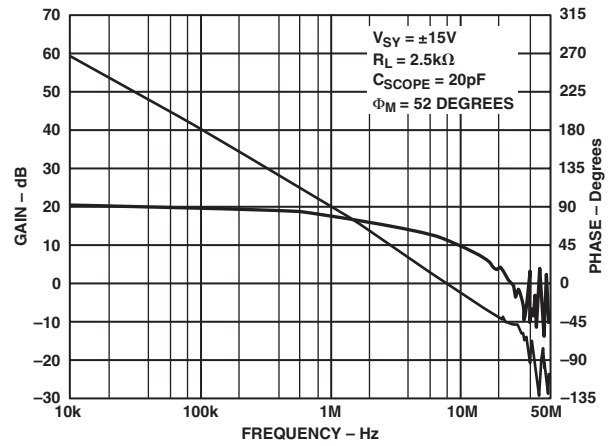

TPC 11. Open-Loop Gain and Phase vs. Frequency

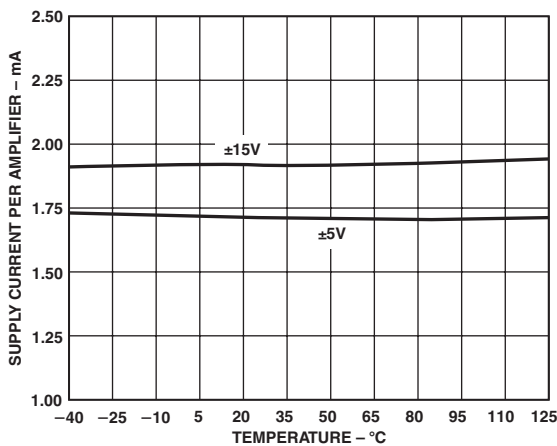

TPC 9. AD8512 Supply Current Per Amplifier vs. Temperature

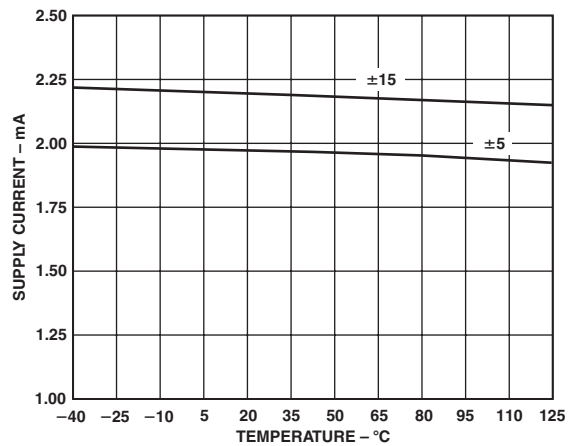

TPC 12. AD8510 Supply Current vs. Temperature

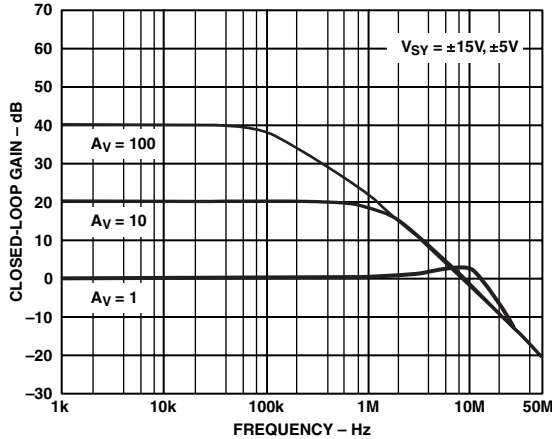

TPC 13. Closed-Loop Gain vs. Frequency

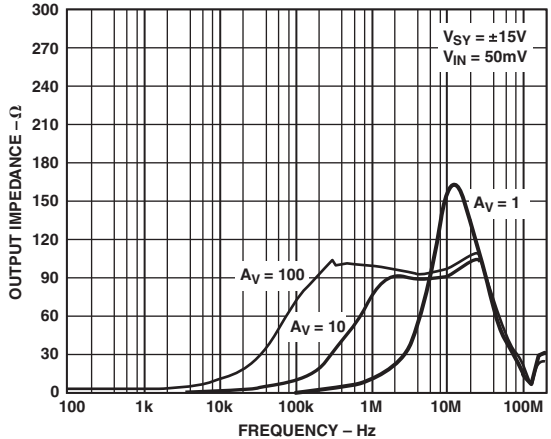

TPC 16. Output Impedance vs. Frequency

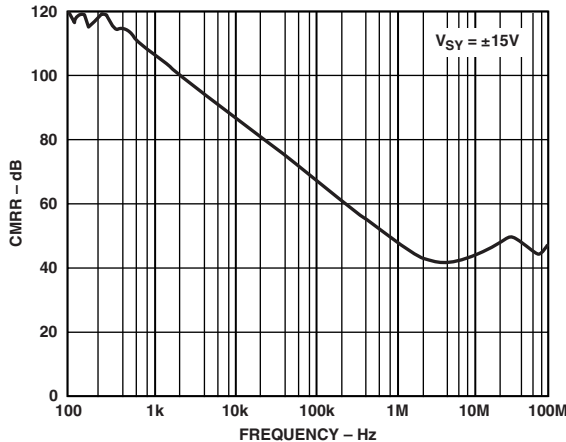

TPC 14. CMRR vs. Frequency

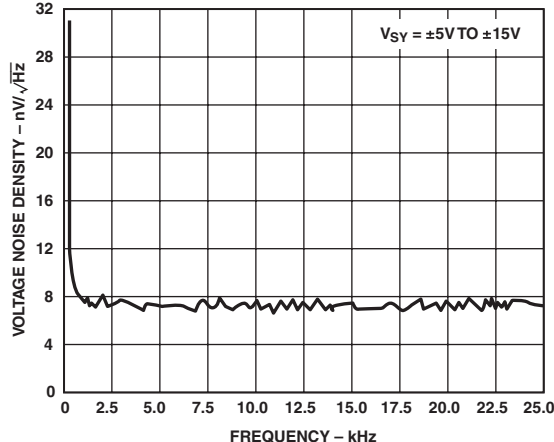

TPC 17. Voltage Noise Density

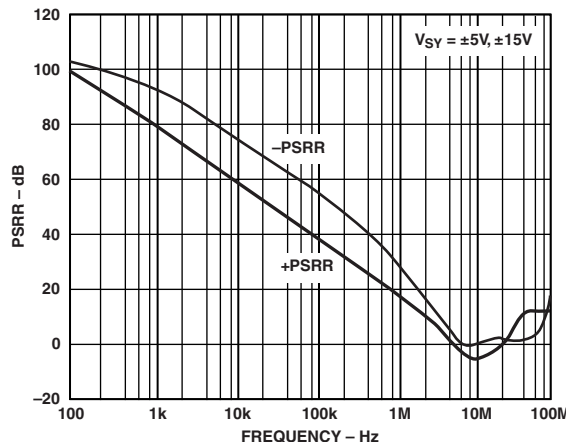

TPC 15. PSRR vs. Frequency

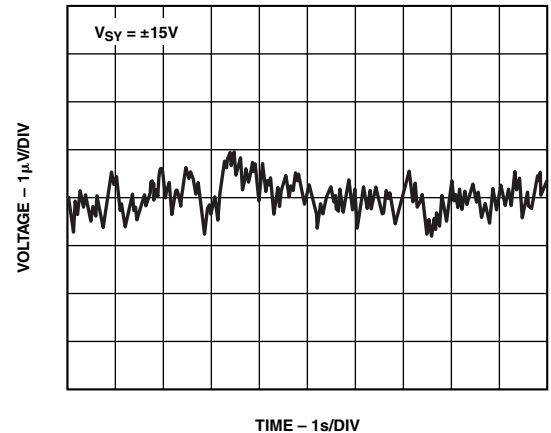

TPC 18. 0.1 Hz to 10 Hz Input Voltage Noise

# AD8510/AD8512

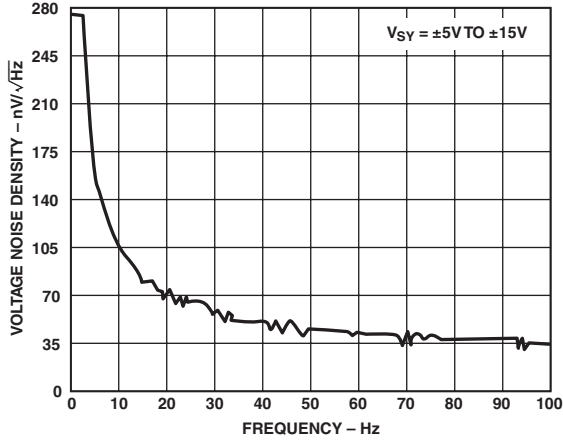

TPC 19. Voltage Noise Density vs. Frequency

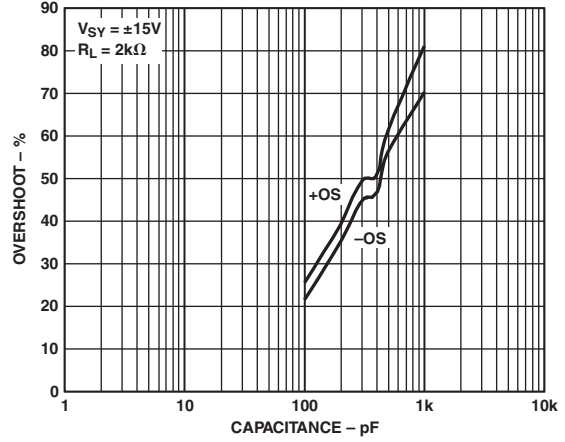

TPC 22. Small Signal Overshoot vs. Load Capacitance

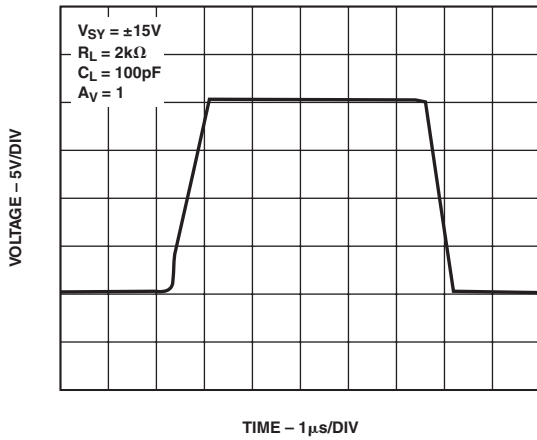

TPC 20. Large Signal Transient Response

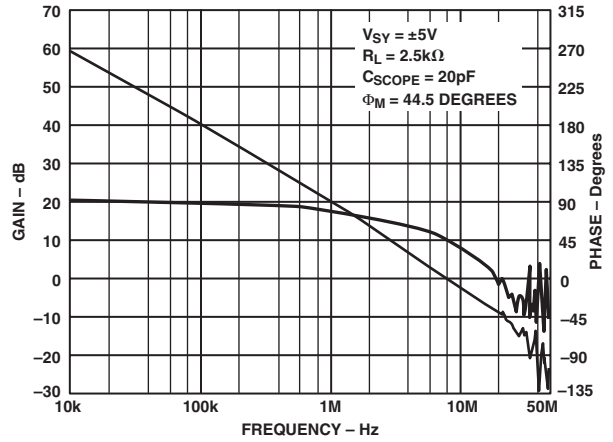

TPC 23. Open-Loop Gain and Phase vs. Frequency

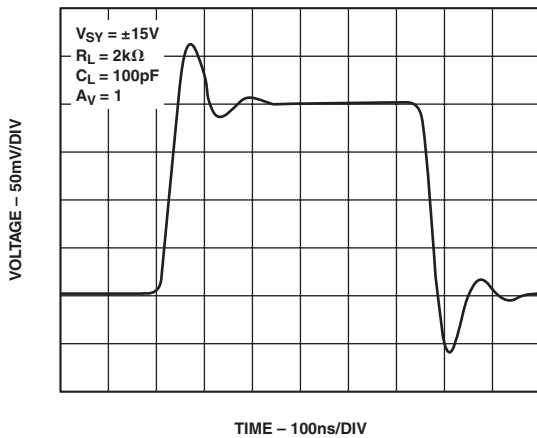

TPC 21. Small Signal Transient Response

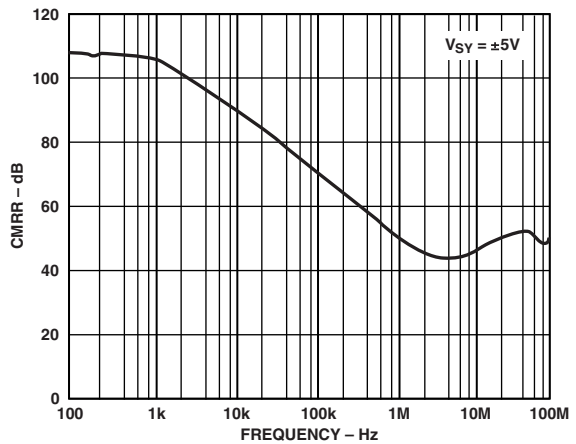

TPC 24. CMRR vs. Frequency



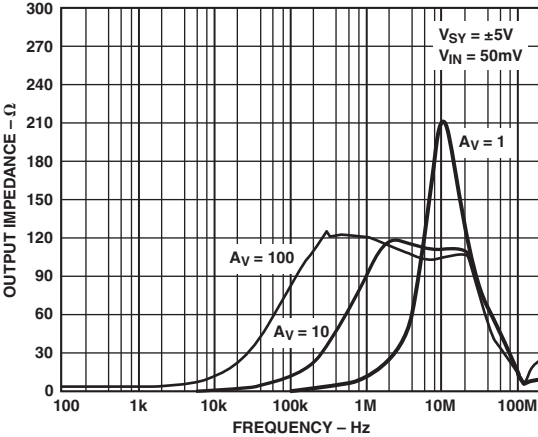

TPC 25. Output Impedance vs. Frequency

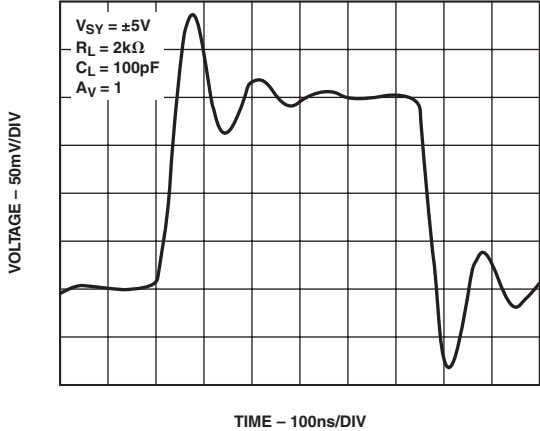

TPC 28. Small Signal Transient Response

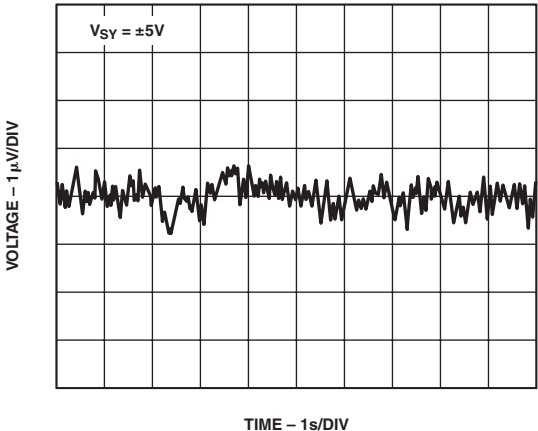

TPC 26. 0.1 Hz to 10 Hz Input Voltage Noise

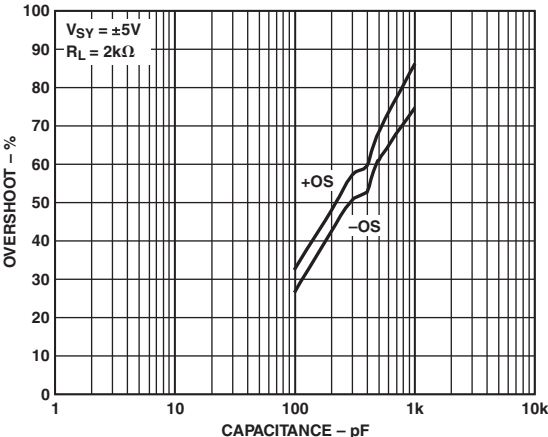

TPC 29. Small Signal Overshoot vs. Load Capacitance

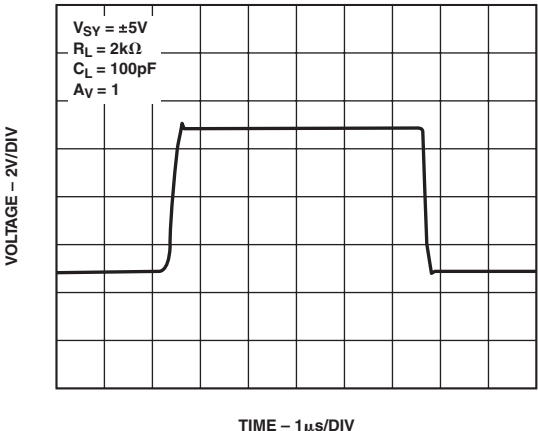

TPC 27. Large Signal Transient Response

# AD8510/AD8512

## GENERAL APPLICATION INFORMATION

### Input Overvoltage Protection

The AD8510/AD8512 have internal protective circuitry that allows voltages as high as 1.4 V beyond the supplies to be applied at the input of either terminal without causing damage.

For higher input voltages, a series resistor is necessary to limit the input current. The resistor value can be determined from the formula:

$$\frac{V_{IN} - V_S}{R_S} \leq 5 \text{ mA}$$

With a very low offset current of  $< 2 \text{ nA}$  up to  $125^\circ\text{C}$ , higher resistor values can be used in series with the inputs. A  $5 \text{ k}\Omega$  resistor will protect the inputs to voltages as high as  $25 \text{ V}$  beyond the supplies and will add less than  $10 \mu\text{V}$  to the offset.

### Output Phase Reversal

Phase reversal is a change of polarity in the transfer function of the amplifier. This can occur when the voltage applied at the input of an amplifier exceeds the maximum common-mode voltage. Phase reversal can cause permanent damage to the device and may result in system lockups. The AD8510/AD8512 do not exhibit phase reversal when input voltages are beyond the supplies.

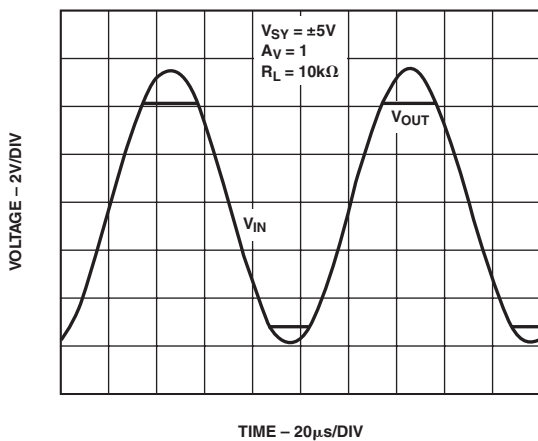

Figure 1. No Phase Reversal

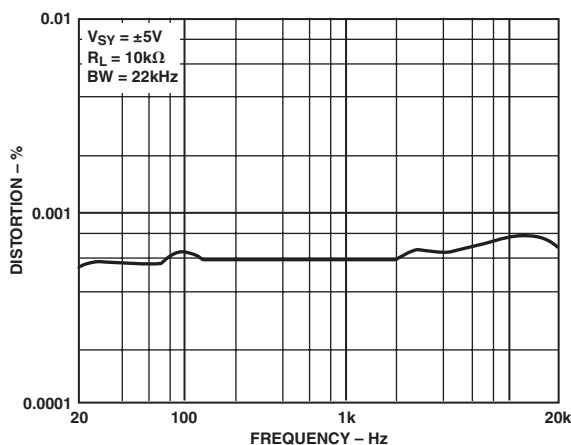

Figure 2. THD + N vs. Frequency

### THD + Noise

The AD8510/AD8512 have low total harmonic distortion and excellent gain linearity, which make these amplifiers a great choice for precision circuits with high closed-loop gain as well as audio application circuits.

Figure 2 shows that the AD8510/AD8512 have approximately 0.0005% of total distortion when configured in positive unity gain (the worst case) and driving a  $100 \text{ k}\Omega$  load.

### Total Noise Including Source Resistors

The low input current noise and input bias current of the AD8510/AD8512 make them the ideal amplifiers for circuits with substantial input source resistance. Input offset voltage increases by less than  $15 \text{ nV}$  per  $500 \Omega$  of source resistance at room temperature.

The total noise density of the circuit is:

$$e_{nTOTAL} = \sqrt{e_n^2 + (i_n R_S)^2 + 4kTR_S}$$

where:

$e_n$  is the input voltage noise density of the AD8510/AD8512

$i_n$  is the input current noise density of the AD8510/AD8512

$R_S$  is the source resistance at the noninverting terminal

$k$  is Boltzman's constant ( $1.38 \times 10^{-23} \text{ J/K}$ )

$T$  is the ambient temperature in Kelvin ( $T = 273 + ^\circ\text{C}$ )

For  $R_S < 3.9 \text{ k}\Omega$ ,  $e_n$  dominates and  $e_{nTOTAL} \approx e_n$

The current noise of the AD8510/AD8512 is so low that its total density does not become a significant term unless  $R_S$  is greater than  $165 \text{ M}\Omega$ , a value that is impractical for most applications.

The total equivalent rms noise over a specific bandwidth is expressed as:

$$e_{nTOTAL} = e_{nTOTAL} \sqrt{BW}$$

where  $BW$  is the bandwidth in Hertz.

NOTE: The above analysis is valid for frequencies larger than  $150 \text{ Hz}$  and assumes flat noise above  $10 \text{ kHz}$ . For lower frequencies, flicker noise ( $1/f$ ) must be considered.

### Settling Time

Settling time is the time it takes the output of the amplifier to reach and remain within a percentage of its final value after a pulse has been applied at the input. The AD8510/AD8512 will settle to within 0.01% in less than  $900 \text{ ns}$  with a step of  $0 \text{ V}$  to  $10 \text{ V}$  in unity gain. This makes it an excellent choice as a buffer at the output of DACs whose settling time is typically less than  $1 \mu\text{s}$ .

In addition to its fast settling time and fast slew rate, the AD8510/AD8512's low offset voltage drift and input offset current maintain full accuracy of 12-bit converters over the entire operating temperature range.

### Overload Recovery Time

Overload recovery, also known as overdrive recovery, is the time it takes the output of an amplifier to recover from a saturated condition to its linear region. This recovery time is particularly important in applications where the amplifier must amplify small signals in the presence of large transient voltages.

Figure 3 shows the positive overload recovery of the AD8510/AD8512. The output recovers in approximately  $200 \text{ ns}$  from a saturated condition.

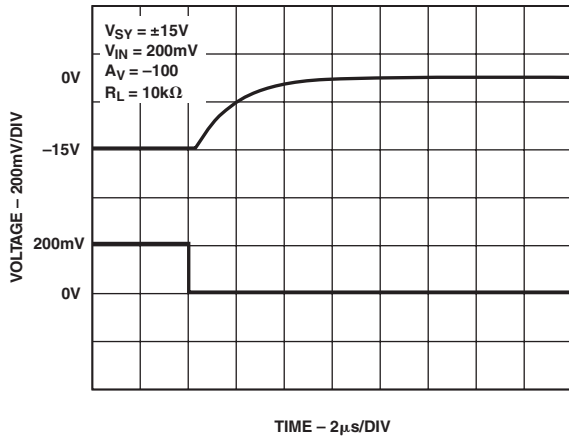

Figure 3. Positive Overload Recovery

The negative overdrive recovery time shown in Figure 4 is less than 200 ns.

In addition to the fast recovery time, the AD8510/AD8512 show excellent symmetry of the positive and negative recovery times. This is an important feature for transient signal rectification because the output signal is kept equally undistorted throughout any given period.

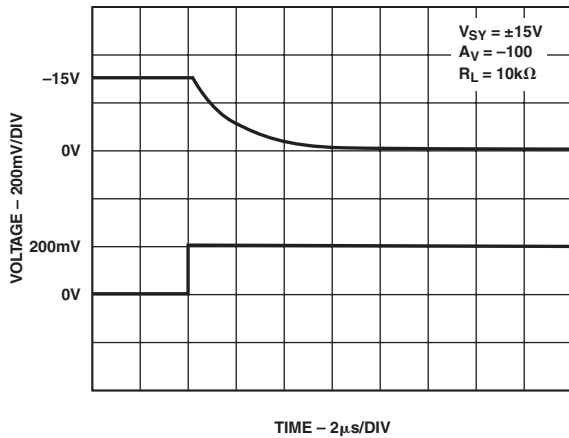

Figure 4. Negative Overload Recovery

### Capacitive Load Drive

The AD8510/AD8512 are unconditionally stable at all gains in inverting and noninverting configurations. They are capable of driving up to 1000 pF of capacitive loads without oscillation in unity gain, the worst-case configuration.

However, as with most amplifiers, driving larger capacitive loads in a unity gain configuration may cause excessive overshoot and ringing or even oscillation. A simple “snubber network” reduces the amount of overshoot and ringing significantly. The advantage of this configuration is that the output swing of the amplifier is not reduced because  $R_S$  is outside the feedback loop.

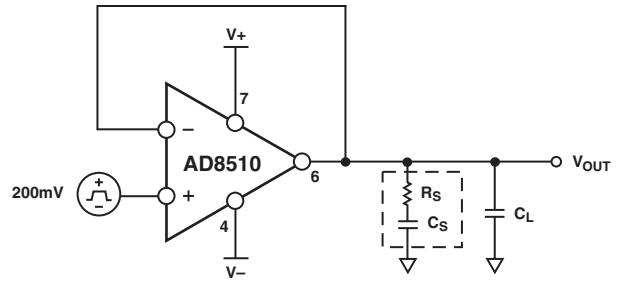

Figure 5. Snubber Network Configuration

Figure 6 shows a scope photograph of the output of the AD8510/AD8512 in response to a 400 mV pulse. The circuit is configured in positive unity gain (worst-case) with a load capacitance of 500 pF.

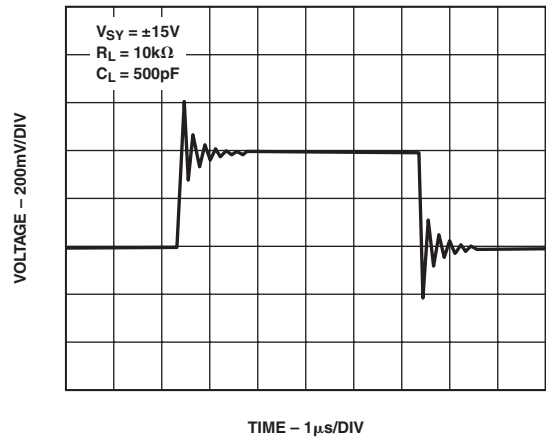

Figure 6. Capacitive Load Drive without Snubber

When the “snubber” circuit is used, the overshoot is reduced from 55% to less than 3% with the same load capacitance. Ringing is virtually eliminated as shown in Figure 7.

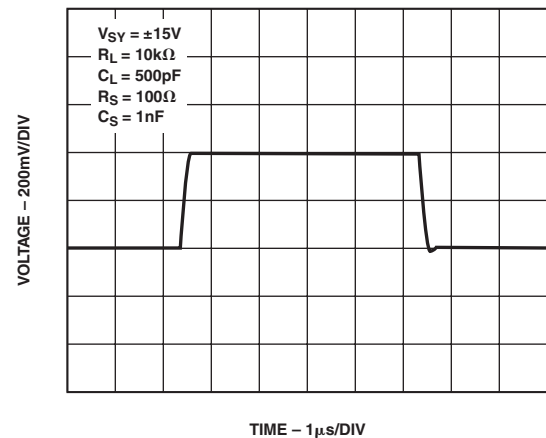

Figure 7. Capacitive Load with Snubber Network

# AD8510/AD8512

Optimum values for  $R_S$  and  $C_S$  depend on the load capacitance and input stray capacitance and are determined empirically. Table I shows a few values that can be used as starting points.

**Table I. Optimum Values for Capacitive Loads**

$C_{LOAD}$	$R_S$ ( $\Omega$ )	$C_S$
500 pF	100	1 nF
2 nF	70	100 pF
5 nF	60	300 pF

## Open-Loop Gain and Phase Response

In addition to its impressive low noise, low offset voltage, and offset current, the AD8510/AD8512 have excellent loop gain and phase response even when driving large resistive and capacitive loads. They were compared to the OPA2132 under the same conditions. With a 2.5 k $\Omega$  load at the output, the AD8510/AD8512 have more than 8 MHz of bandwidth and a phase margin of more than 52°.

The OPA2132, on the other hand, has only 4.5 MHz of bandwidth and 28° of phase margin under the same test conditions. Even with a 1 nF capacitive load in parallel with the 2 k $\Omega$  load at the output, the AD8510/AD8512 show much better response than the OPA2132, whose phase margin is degraded to less than 0°, indicating oscillation.

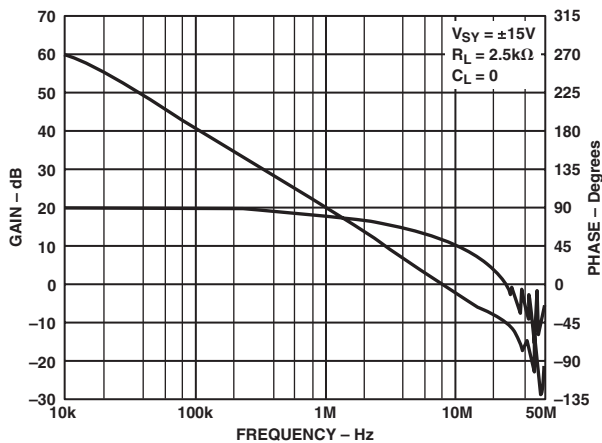

Figure 8. Frequency Response of the AD8510/AD8512

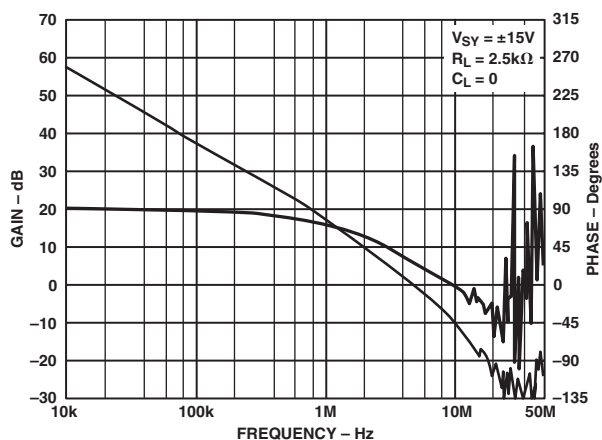

Figure 9. Frequency Response of the OPA2132

## Precision Rectifiers

Rectifying circuits are used in a multitude of applications. One of the most popular uses is in the design of regulated power supplies where a rectifier circuit is used to convert an input sinusoid to a unipolar output voltage. There are some potential problems for amplifiers used in this manner.

When the input voltage ( $V_{IN}$ ) is negative, the output is zero. The magnitude of  $V_{IN}$  is doubled at the inputs of the op amp. This voltage can exceed the power supply voltage. This would damage some amplifiers permanently. The op amp must come out of saturation when  $V_{IN}$  is negative. This delays the output signal, since the amplifier requires time to enter its linear region.

The AD8510/AD8512 have a very fast overdrive recovery time, which makes them a great choice for the rectification of transient signals. The symmetry of the positive and negative recovery times is also important in keeping the output signal undistorted.

Figure 10 shows the test circuit of the rectifier. The first stage of the circuit is a half wave rectifier. When the sine wave applied at the input is positive, the output follows the input response. During the negative cycle of the input, the output tries to swing negative to follow the input but the power supply restrains it to zero.

In a similar fashion, the second stage is a follower during the positive cycle of the sine wave and an inverter during the negative cycle.

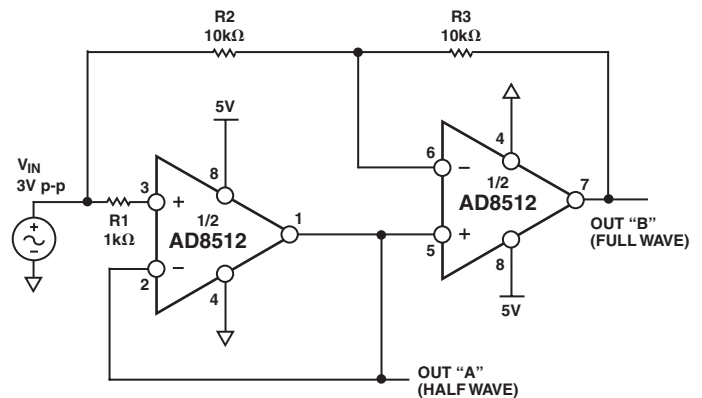

Figure 10. Half Wave and Full Wave Rectifier

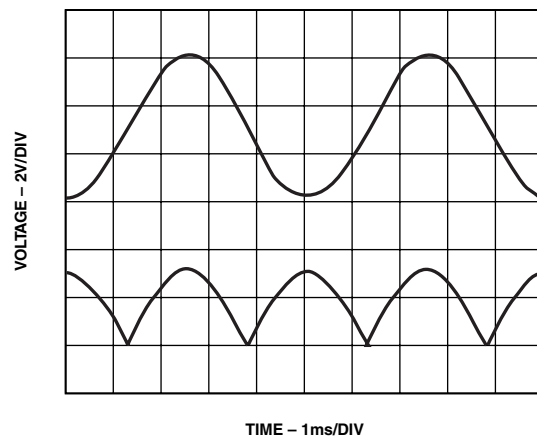

Figure 11. Half Wave Rectified Signal (Out A)

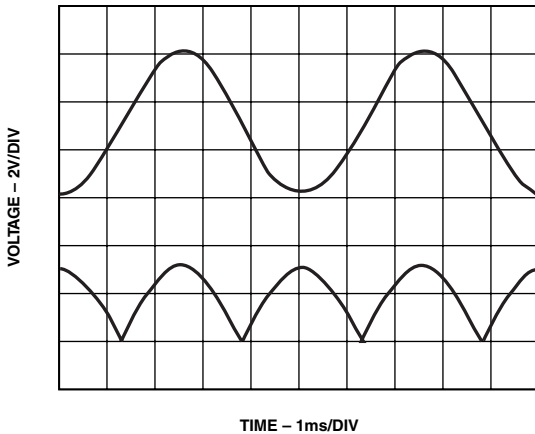

Figure 12. Full Wave Rectified Signal (Out B)

## I-V CONVERSION APPLICATIONS

### Photodiode Circuits

Common applications for I-V conversion include photodiode circuits where the amplifier is used to convert a current emitted by a diode placed at the positive input terminal, into an output voltage.

The AD8510/AD8512 low input bias current, wide bandwidth, and low noise make these amplifiers an excellent choice for various photodiode applications, including fax machines, fiber optic controls, motion sensors, and bar code readers.

The circuit shown in Figure 13 uses a silicon diode with zero bias voltage. This is known as a Photovoltaic Mode; this configuration limits the overall noise and is suitable for instrumentation applications.

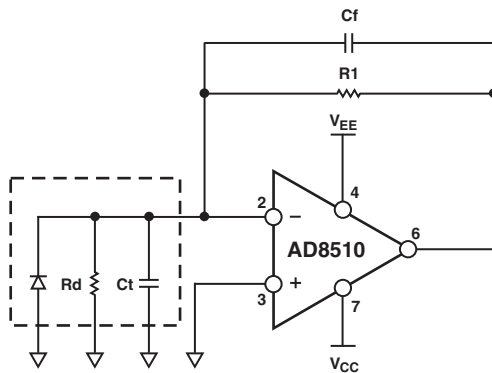

Figure 13. Equivalent Preamplifier Photodiode Circuit

A larger signal bandwidth can be attained at the expense of additional output noise. The total input capacitance ( $C_t$ ) consists of the sum of the diode capacitance (typically 3 pF to 4 pF) and the amplifier's input capacitance (12 pF), which includes external parasitic capacitance.  $C_t$  creates a pole in the frequency response, which may lead to an unstable system. To ensure stability and optimize the bandwidth of the signal, a capacitor is placed in the feedback loop of the circuit shown in Figure 13. It creates a zero and yields a bandwidth whose frequency is  $1/(2(R1Cf))$ .

The value of  $R1$  can be determined by the ratio  $V/I_D$ , where  $V$  is the desired output voltage of the op amp and  $I_D$  is the diode current. For example, if  $I_D$  is 100  $\mu$ A and the output voltage that is desired is 10 V, then  $R1$  should be 100 k $\Omega$ .  $R_d$  is a junction resistance that drops typically by a factor of 2 for every 10°C increase in temperature. A typical value for  $R_d$  is 1000 M $\Omega$ . Since  $R_d \gg R1$ , the circuit behavior is not impacted by the effect of the junction resistance. The maximum signal bandwidth is:

$$f_{MAX} = \sqrt{\frac{C_t}{2\pi R2 C_t}}$$

where  $f_t$  is the unity gain frequency of the amplifier.

Using the parameters of the example above,  $C_f \approx 1$  pF. This yields a signal bandwidth of about 2.6 MHz.

$$C_f = \sqrt{\frac{C_t}{2\pi R2 f_t}}$$

where  $f_t$  is the unity gain frequency of the op amp, achieves a phase margin,  $\Phi_m$ , of approximately 45°.

A higher phase margin can be obtained by increasing the value of  $C_f$ . Setting  $C_f$  to twice the previous value yields approximately  $\Phi_m = 65^\circ$  and a maximally flat frequency response. This comes at a cost of 50% reduction in the maximum signal bandwidth.

### Signal Transmission Applications

One popular signal transmission method uses pulsewidth modulation. High data rates may require a fast comparator rather than an op amp. However, the need for sharp and undistorted signals may favor using a linear amplifier.

The AD8510/AD8512 make excellent voltage comparators. In addition to a high slew rate, the AD8510/AD8512 have a very fast saturation recovery time. In the absence of feedback, the amplifiers are in Open-Loop Mode (very high gain). In this mode of operation, they spend much of their time in saturation.

The circuit of Figure 14 compares two signals of different frequencies, namely, a sine wave of 100 Hz and a triangular wave of 1 kHz. Figure 15 shows a scope photograph of the output waveform. A pull-up resistor (typically 5 k $\Omega$ ) may be connected from the output to  $V_{CC}$  if the output voltage needs to reach the positive rail. The trade-off is that power consumption will be higher.

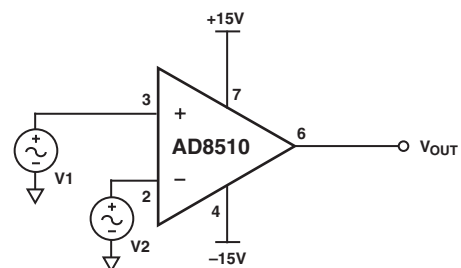

Figure 14. Pulsewidth Modulator

# AD8510/AD8512

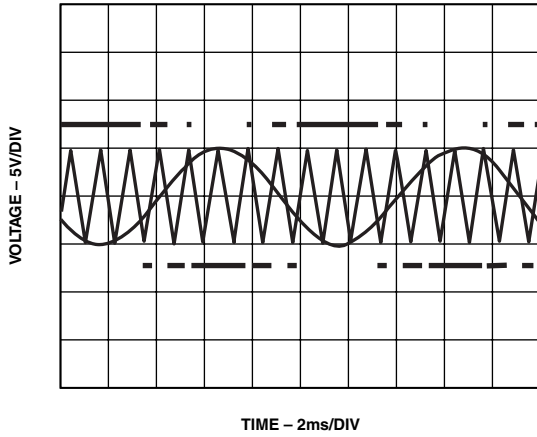

Figure 15. Pulsewidth Modulation

## Crosstalk

Crosstalk, also known as channel separation, is a measure of signal feedthrough from one channel to the other on the same IC. The AD8510/AD8512 have a channel separation better than -140 dB for frequencies up to 20 kHz, and better than -130 dB for frequencies up to 10 MHz.

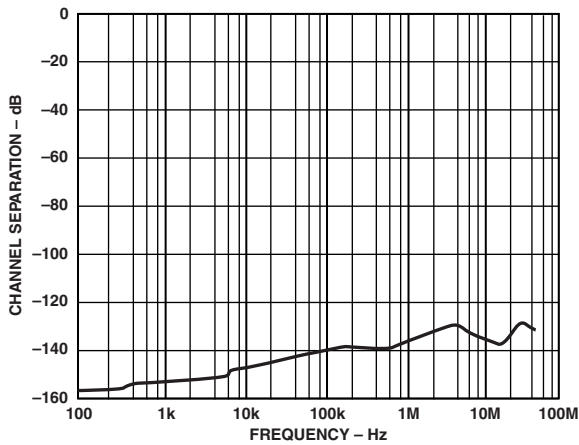

Figure 16. Channel Separation

## Precision Current Monitoring

The low offset voltage and input bias current of the AD8510/AD8512 make them an excellent choice for precision current sensing applications.

The circuit of Figure 17 shows a high side current monitor.  $R_{SENSE}$  creates a voltage drop across it that is proportional to the load current. This voltage appears at the inverting node of the op amp and creates a current through  $R2$ .

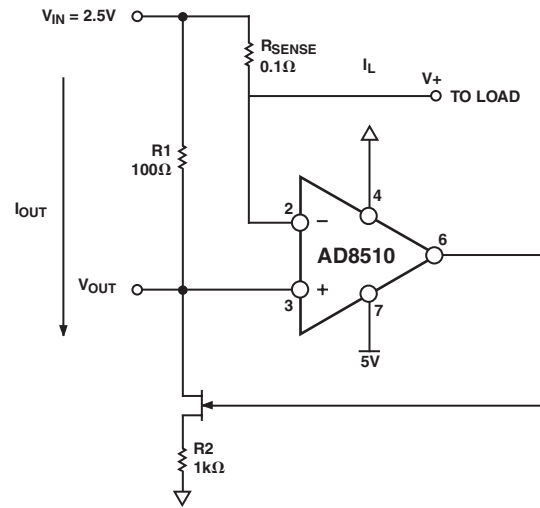

Figure 17. High Side Current Monitor

The equation for the output voltage is written:

$$V_{OUT} = V_{+} \left( \frac{-I_L \times R_{SENSE}}{R_1} \right) \times R_2$$

OUTLINE DIMENSIONS

8-Lead Standard Small Outline Package [SOIC]  
Narrow Body  
(R-8)

Dimensions shown in millimeters and (inches)

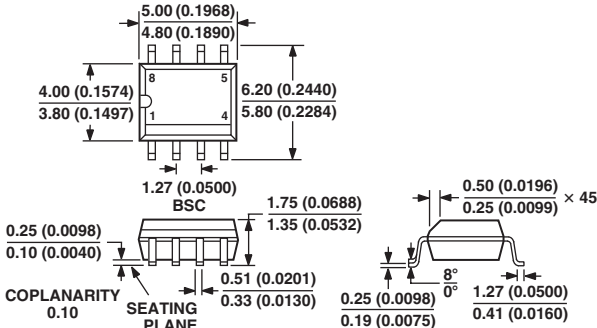

COMPLIANT TO JEDEC STANDARDS MS-012AA  
CONTROLLING DIMENSIONS ARE IN MILLIMETERS; INCH DIMENSIONS (IN PARENTHESES) ARE ROUNDED-OFF MILLIMETER EQUIVALENTS FOR REFERENCE ONLY AND ARE NOT APPROPRIATE FOR USE IN DESIGN

8-Lead Mini Small Outline Package [MSOP]  
(RM-8)

Dimensions shown in millimeters

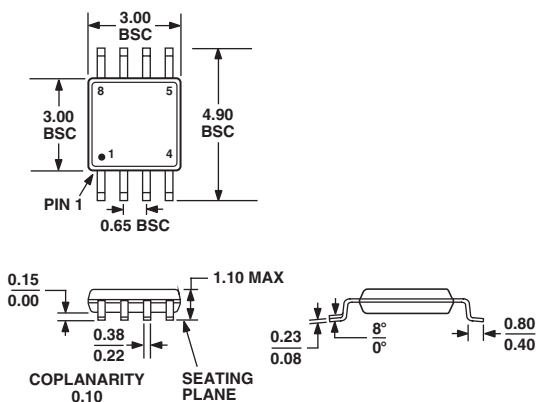

COMPLIANT TO JEDEC STANDARDS MO-187AA

# AD8510/AD8512

## Revision History

<b>Location</b>	<b>Page</b>
<b>3/03—Data Sheet changed from REV. A to REV. B.</b>	
Updated Figure 5 . . . . .	11
Updated OUTLINE DIMENSIONS . . . . .	15
<b>/02—Data Sheet changed from REV. 0 to REV. A.</b>	
Added AD8510 Model . . . . .	Universal
Added PIN CONFIGURATIONS . . . . .	1
Changes to SPECIFICATIONS . . . . .	2
Changes to ORDERING GUIDE . . . . .	4
Changes to TPCs 2 and 3 . . . . .	5
Added new TPCs 10 and 12 . . . . .	6
Replaced TPC 20 . . . . .	8
Replaced TPC 27 . . . . .	9
Changes to GENERAL APPLICATION INFORMATION section . . . . .	10
Changes to Figure 5 . . . . .	11
Changes to I-V CONVERSION APPLICATIONS section . . . . .	13
Changes to Figures 13 and 14 . . . . .	13
Changes to Figure 17 . . . . .	14

C02772-0-3/03(B)

PRINTED IN U.S.A.