

AD8509/AD8511

FEATURES

Single-Supply Operation: 3.3 V to 5 V
 High Output Current: 300 mA
 Low Supply Current: 6 mA
 Stable with 1000 pF Loads
 Pin Compatible with LMC6009
 Pin Compatible with CL-FP6131

APPLICATIONS

LCD Driver

FUNCTIONAL BLOCK DIAGRAM

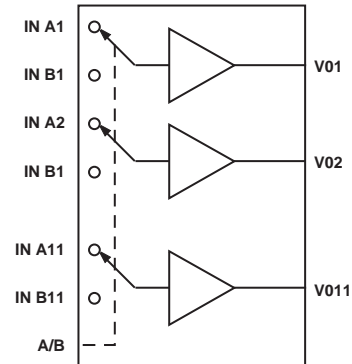

PIN CONFIGURATIONS 48-Lead TSSOP (RU Suffix)

GENERAL DESCRIPTION

The AD8509 is a 9-channel (AD8511 an 11-channel) LCD reference driver designed to drive 64 gray scale column drivers. Each buffer has an A/B input used to select between two voltages for LCD displays. These buffers are used to drive the resistor ladders of LCD column drivers for gamma correction.

These LCD drivers have higher slew rates and output drive current than similar competitive parts. This increases the stability of the reference ladder, resulting in better gray scale and visual performance.

The AD8509 and AD8511 are specified over the -20°C to $+85^{\circ}\text{C}$ temperature range. They are available in 48-lead thin shrink small outline (TSSOP) surface mount packages in tape and reel.

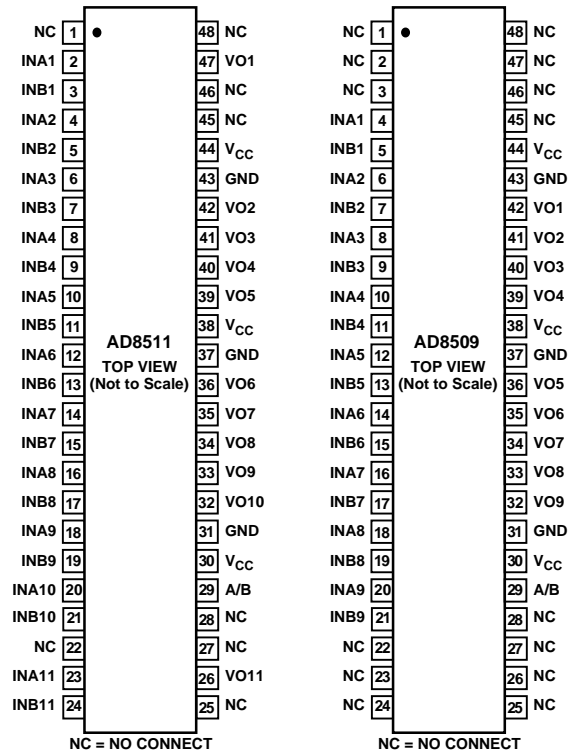

REV. 0

Information furnished by Analog Devices is believed to be accurate and reliable. However, no responsibility is assumed by Analog Devices for its use, nor for any infringements of patents or other rights of third parties which may result from its use. No license is granted by implication or otherwise under any patent or patent rights of Analog Devices.

AD8509/AD8511—SPECIFICATIONS

ELECTRICAL CHARACTERISTICS ($V_S = +5\text{ V}$, $T_A = +25^\circ\text{C}$, unless otherwise noted)

Parameter	Symbol	Conditions	Min	Typ	Max	Units
INPUT CHARACTERISTICS						
Offset Voltage	V_{OS}				20	mV
Input Bias Current	I_B				50	nA
Voltage Gain	A_{VO}		0.985			V/V
OUTPUT CHARACTERISTICS						
Output Voltage High	V_{OH}	$I_{LOAD} = +20\text{ mA}$	4.8			V
Output Voltage Low	V_{OL}	$I_{LOAD} = -20\text{ mA}$			200	mV
Output Short Circuit Current	I_{SC}		120	350		mA
POWER SUPPLY						
Load Regulation		$V_{IN} = 0.5\text{ V} - 4.5\text{ V}$, $I_{SOURCE} = 20\text{ mA}$		7		mV
Load Regulation		$V_{IN} = 0.5\text{ V} - 4.5\text{ V}$, $I_{SINK} = 20\text{ mA}$		7		mV
Supply Current	LCD09	I_{SY} , $V_{IN} = 2.5\text{ V}$			8.5	mA
Supply Current	LCD11	I_{SY} , $V_{IN} = 2.5\text{ V}$			10	mA
DYNAMIC PERFORMANCE						
Slew Rate		$C_L = 15\text{ pF}$		7		V/ μs
Slew Rate		$R_L = 250\ \Omega$		6.2		V/ μs
Settling Time	t_s	$IDC = 13\text{ mA}$ (Sink/Source)		3	6	μs
LOGIC INPUT CHARACTERISTICS						
Input Current Low	I_{IL}				1.0	μA
Input Current High	I_{IH}				1.5	μA
Input Voltage Low	V_{IL}				0.8	V
Input Voltage High	V_{IH}		2.0			V

Specifications subject to change without notice.

ABSOLUTE MAXIMUM RATINGS*

Supply Voltage	+7 V
Input Voltage	GND to V_S
Storage Temperature Range	
RU Package	-65°C to $+150^\circ\text{C}$
Operating Temperature Range	
AD8509A/AD8511A	-20°C to $+85^\circ\text{C}$
Junction Temperature Range	
RU Package	-65°C to $+150^\circ\text{C}$
Lead Temperature Range (Soldering, 60 sec)	$+300^\circ\text{C}$

*Stresses above those listed under Absolute Maximum Ratings may cause permanent damage to the device. This is a stress rating only; the functional operation of the device at these or any other conditions above those indicated in the operational sections of this specification is not implied. Exposure to absolute maximum rating conditions for extended periods may affect device reliability.

Package Type	θ_{JA} *	θ_{JC}	Units
48-Lead TSSOP (RU)	115	42	$^\circ\text{C/W}$

NOTE

* θ_{JA} is specified for the worst case conditions, i.e., θ_{JA} specified for device soldered in circuit board for surface mount packages.

CAUTION

ESD (electrostatic discharge) sensitive device. Electrostatic charges as high as 4000 V readily accumulate on the human body and test equipment and can discharge without detection. Although the AD8509/AD8511 features proprietary ESD protection circuitry, permanent damage may occur on devices subjected to high energy electrostatic discharges. Therefore, proper ESD precautions are recommended to avoid performance degradation or loss of functionality.

ORDERING GUIDE

Model	Temperature Range	Package Description	Package Options
AD8509ARU*	-20°C to $+85^\circ\text{C}$	48-Lead TSSOP	RU-48
AD8511ARU*	-20°C to $+85^\circ\text{C}$	48-Lead TSSOP	RU-48

* Available in 2,000 piece reels only.

Table I. MUX Function

A/B Select (Pin 29)	Input
Logic HI	INAx
Logic LOW	INBx



Typical Performance Characteristics—AD8509/AD8511

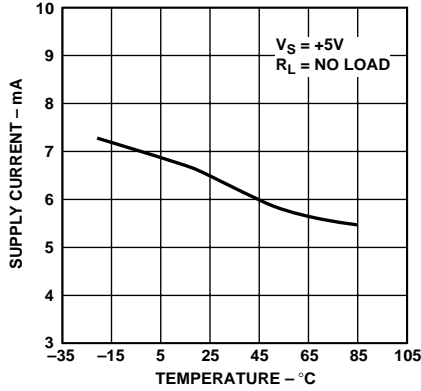

Figure 1. Supply Current vs. Temperature

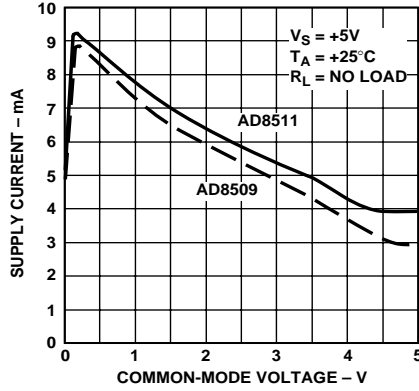

Figure 2. Supply Current vs. Common-Mode Voltage

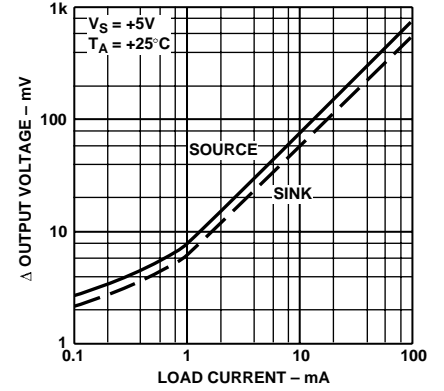

Figure 3. Output Voltage to Supply Rail vs. Load Current

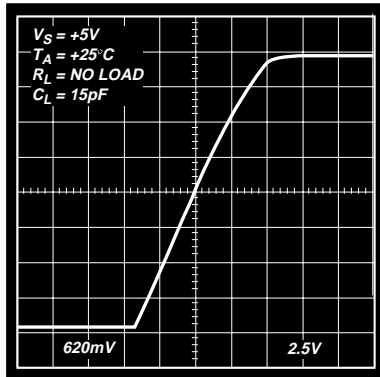

Figure 4. Large Signal Transient Response – Rising

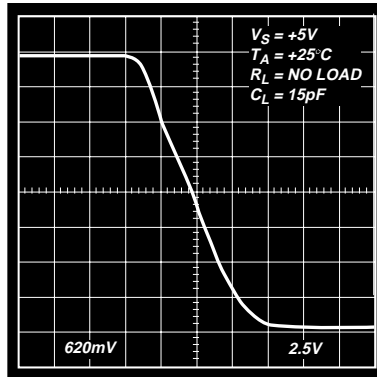

Figure 5. Large Signal Transient Response – Falling

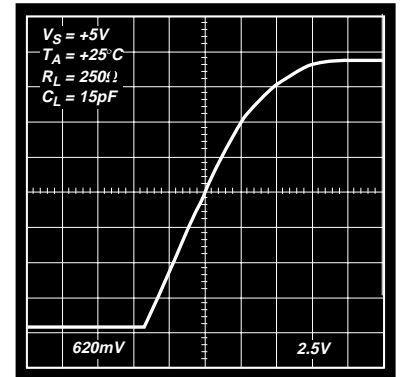

Figure 6. Large Signal Transient Response – Rising

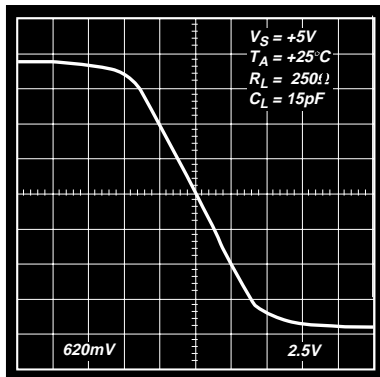

Figure 7. Large Signal Transient Response – Falling

AD8509/AD8511

APPLICATIONS

The AD8509 and AD8511 are CMOS buffers with A/B inputs, which are used to select between two different reference voltages set up by an external resistor ladder. Input bias currents are orders of magnitude less than competitive parts, allowing very large resistor ladders to be used to save supply current. A guaranteed value of 50 nA is much higher than actual values and is limited by leakage in the test system.

Buffer outputs are designed to drive resistive loads. They are also stable with capacitive loads, so no resistors should be used in series with these outputs to attain the best display performance. Outputs have high slew rates and 6 μ s settling times. Each output is capable of delivering a minimum of 120 mA, assuring fast response to varying loads.

The AD8509 is a 9-channel buffer and is similar to the LMC6009 in functionality. The AD8511 is an 11-channel buffer similar to the CL-FP6131. However, the control to select either 9- or 11-channel operation, the EN_11 pin of the CL-FP6131, is not available on the AD8511. If 9-channel operation is desired, use the AD8509.

Power supply pins on the AD8509 and AD8511 have multiple ground and V_{CC} connections. Because of the high peak currents that these buffers can deliver, it is strongly recommended that all be connected, and that the V_{CC} pins be suitably bypassed.

C3237-8-10/97

OUTLINE DIMENSIONS

Dimensions shown in inches and (mm).

48-Lead TSSOP (RU Suffix)

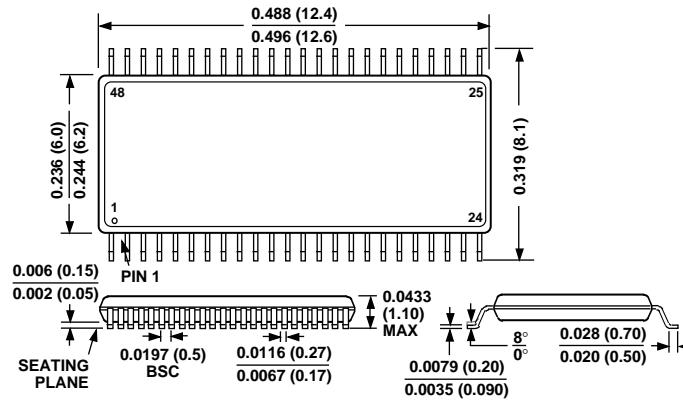

PRINTED IN U.S.A.